

Eg # 84642

TEKTRONIX®

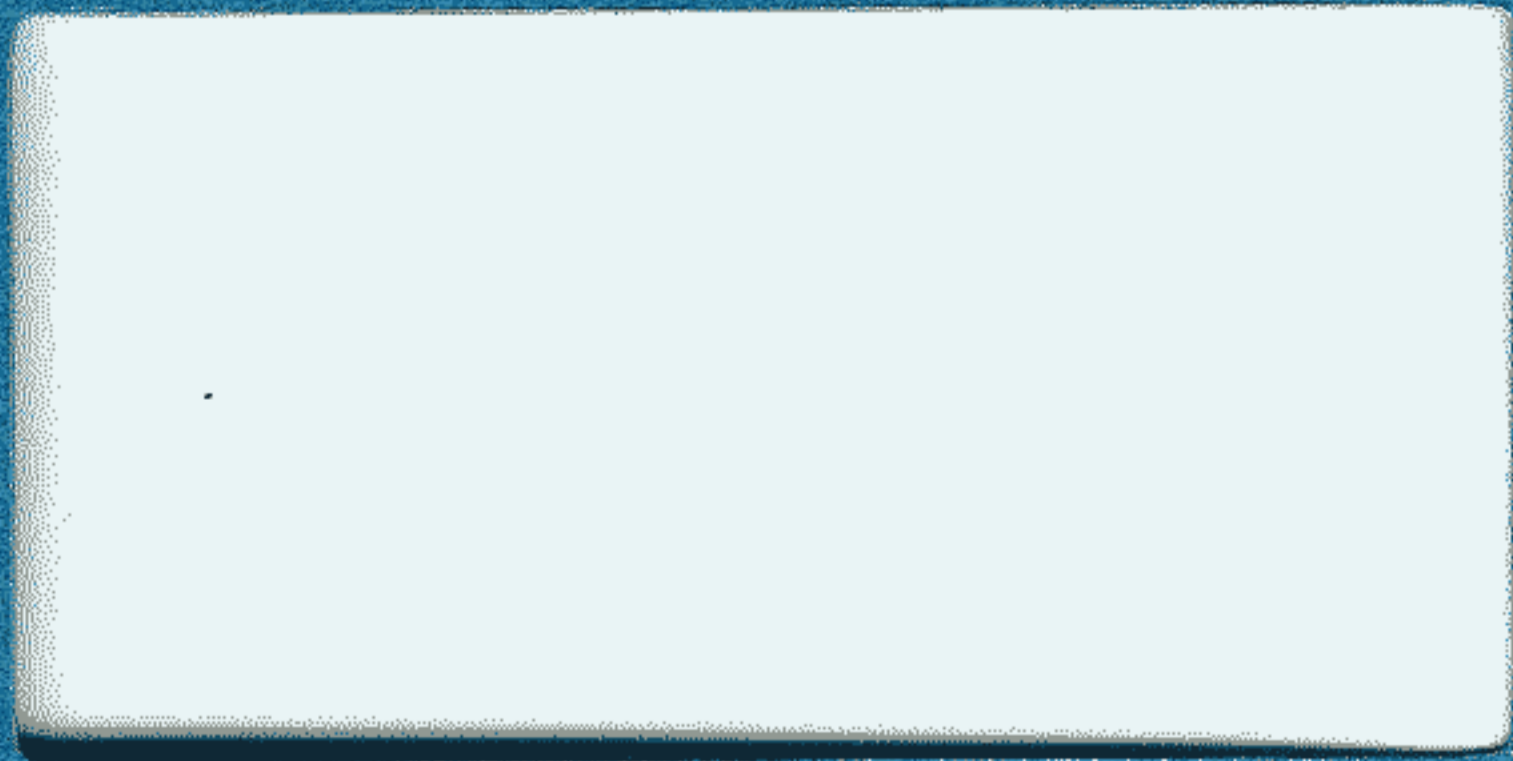

INSTRUCTION MANUAL

Received 8-21-75

BEFORE READING

PLEASE CHECK FOR CHANGE INFORMATION
AT THE REAR OF THIS MANUAL.

THIS MANUAL REPRINTED JULY 1975

TEKTRONIX®

465
OSCILLOSCOPE
WITH OPTIONS
(SN B250000 & UP)
SERVICE

INSTRUCTION MANUAL

Tektronix, Inc.
P.O. Box 500
Beaverton, Oregon 97077

Serial Number B262584



WARRANTY

All TEKTRONIX instruments are warranted against defective materials and workmanship for one year. Any questions with respect to the warranty should be taken up with your TEKTRONIX Field Engineer or representative.

All requests for repairs and replacement parts should be directed to the TEKTRONIX Field Office or representative in your area. This will assure you the fastest possible service. Please include the instrument Type Number or Part Number and Serial Number with all requests for parts or service.

Specifications and price change privileges reserved.

Copyright © 1974 by Tektronix, Inc., Beaverton, Oregon. Printed in the United States of America. All rights reserved. Contents of this publication may not be reproduced in any form without permission of Tektronix, Inc.

U.S.A. and foreign TEKTRONIX products covered by U.S. and foreign patents and/or patents pending.

TEKTRONIX is a registered trademark of Tektronix, Inc.

TABLE OF CONTENTS

	Page
LIST OF ILLUSTRATIONS	v
LIST OF TABLES	v
SECTION 1	SPECIFICATIONS
	Introduction 1-1
	VERTICAL DEFLECTION SYSTEM 1-1
	TRIGGERING 1-1
	HORIZONTAL DEFLECTION SYSTEM 1-2
	X-Y OPERATION 1-2
	CALIBRATOR 1-3
	Z-AXIS INPUT 1-3
	SIGNAL OUTPUTS 1-3
	POWER SOURCE 1-3
	CATHODE RAY TUBE (CRT) 1-3
	SUPPLEMENTAL INFORMATION 1-3
	Vertical Deflection System 1-3
	Triggering 1-4
	Horizontal Deflection System 1-4
	Calibrator 1-4
	External Z-Axis Input 1-4
	Output Resistances 1-4
	Cathode Ray Tube (CRT) 1-4
SECTION 2	OPERATING INFORMATION
	Introduction 2-1
	Instrument Repackaging 2-1
	Operating Voltage 2-1
	CONTROLS AND CONNECTORS 2-2
	Introduction 2-2
	Cathode Ray Tube (CRT) and Display 2-2
	Vertical Deflection System
	Channel 1 and Channel 2 2-2
	A and B Triggering 2-4
	A and B Sweep 2-5
	Calibrator and Power 2-6
	Rear Panel 2-6
	OBTAINING BASIC DISPLAYS 2-6
	Introduction 2-6
	Normal Sweep Display 2-6
	Magnified Sweep Display 2-7
	Delayed Sweep Display 2-7
	Mixed Sweep Display 2-7
	X-Y Display 2-7

TABLE OF CONTENTS (cont)

SECTION 3	CIRCUIT DESCRIPTION	Page
	Introduction	3-1
	Digital Logic	3-1
	BLOCK DIAGRAM	3-1
	CHANNEL 1 PREAMP	3-3
	Introduction	3-3
	Scale Factor Switching	3-4
	Input Coupling	3-4
	Input Attenuator	3-4
	Source Follower	3-4
	First Cascode Amplifier	3-5
	Second Cascode Amplifier	3-5
	Third Cascode Amplifier	3-5
	CHANNEL 2 PREAMP	3-5
	Introduction	3-5
	Second Cascode Amplifier	3-5
	Third Cascode Amplifier	3-6
	VERTICAL SWITCHING CIRCUIT	3-6
	Introduction	3-6
	Diode Gates	3-6
	Switching Multivibrator	3-7
	Delay Line Driver	3-9
	Reference Feedback Amplifier	3-9
	Normal Trigger Pickoff	3-9
	VERTICAL OUTPUT AMPLIFIER	3-9
	Introduction	3-9
	Delay Line	3-9
	Vertical Output Amplifier—Discrete Version	3-9
	Vertical Output Amplifier—IC Version	3-10
	A AND B TRIGGER GENERATORS	3-10
	Introduction	3-10
	Trigger Source	3-10
	Trigger Coupling	3-10
	Input Source Follower	3-10
	Paraphase Amplifier	3-10
	Tunnel Diode Driver	3-11
	A AND B SWEEP GENERATOR	3-11
	Introduction	3-11
	Disconnect Amplifier	3-12
	Output Buffer Amplifier	3-12
	Sweep Start Amplifier	3-12
	Logic Multivibrator	3-12
	B Sweep Differences	3-12
	SWEEP AND Z-AXIS LOGIC CIRCUIT	3-13
	Introduction	3-13
	A Sweep Gate	3-13

TABLE OF CONTENTS (cont)

	Page
SECTION 3 (cont)	
B Sweep Gate	3-13
Sweep Control Integrated Circuit	3-13
Holdoff Timing	3-14
A Sweep Holdoff Amplifier	3-14
B Sweep Holdoff Amplifier	3-14
B Sweep Latch	3-14
A Sweep Z Axis Gate	3-14
B Sweep Z Axis	3-15
A +Gate and B +Gate Emitter Followers	3-15
HORIZONTAL AMPLIFIER	3-15
Introduction	3-15
X-Axis Amplifier	3-15
Input Paraphase Amplifier	3-16
Gain Setting Amplifier	3-16
Output Amplifier	3-16
CRT CIRCUIT	3-17
Introduction	3-17
High Voltage Oscillator	3-17
High Voltage Regulator	3-18
High Voltage Rectifier and Output	3-18
CRT Control Circuits	3-18
Z Axis Amplifier	3-18
DC Restorer Circuit	3-19
CALIBRATOR	3-19
Introduction	3-19
Multivibrator	3-19
Output Amplifier	3-19
A TRIGGER VIEW AMPLIFIER	3-20
Introduction	3-20
Amplifier	3-20
LOW VOLTAGE POWER SUPPLY	3-20
Introduction	3-20
Power Input	3-20
Secondary Circuit	3-20
FAN MOTOR CIRCUIT	3-22
SECTION 4	
MAINTENANCE	
Introduction	4-1
Cabinet Removal	4-1
PREVENTIVE MAINTENANCE	4-1
Introduction	4-1
Cleaning	4-1
Visual Inspection	4-2
Lubrication	4-3
Semiconductor Checks	4-3
Recalibration	4-3

TABLE OF CONTENTS (cont)

	Page
SECTION 4 (cont) TROUBLESHOOTING	4-3
Introduction	4-3
Troubleshooting Aids	4-3
Troubleshooting Equipment	4-5
Troubleshooting Techniques	4-5
CORRECTIVE MAINTENANCE	4-7
Introduction	4-7
Obtaining Replacement Parts	4-7
Soldering Techniques	4-8
Component Removal and Replacement	4-9
Recalibration After Repair	4-14
Instrument Repackaging	4-14
 SECTION 5 PERFORMANCE CHECK	
Purpose	5-1
Limits and Tolerances	5-1
Line Voltage Selection	5-1
Equipment Required	5-1
Special Fixtures	5-1
Test Equipment Alternatives	5-1
INDEX TO PERFORMANCE CHECK	5-1
VERTICAL	5-3
TRIGGERS	5-7
HORIZONTAL	5-10
 SECTION 6 CALIBRATION	
Purpose	6-1
Limits and Tolerances	6-1
Step Titles	6-1
Line Voltage Selection	6-1
Internal Adjustments	6-1
Display	6-1
Test Equipment Required	6-1
Interactions	6-1
INDEX TO CALIBRATION PROCEDURE	6-5
POWER SUPPLY	6-8
DISPLAY AND Z-AXIS	6-10
VERTICAL	6-12
TRIGGERS	6-24
HORIZONTAL	6-35
GATES, CALIBRATOR AND EXT Z-AXIS	6-43
 SECTION 7 ELECTRICAL PARTS LIST	7-1
OPTIONS	TAB PAGE
 SECTION 8 DIAGRAMS	8-1
 SECTION 9 MECHANICAL PARTS LIST	9-1
CHANGE INFORMATION	

LIST OF ILLUSTRATIONS

	Page
Fig. 1-1	465 Oscilloscope
Fig. 2-1	Power supply regulating range selector.
Fig. 2-2	Front and rear panel controls and connectors.
Fig. 3-1	Basic block diagram of the 465.
Fig. 3-2	Detailed block diagram of the Channel 1 Preamplifier.
Fig. 3-3	Detailed block diagram of the Channel 2 Preamplifier.
Fig. 3-4	Detailed block diagram of the Vertical Switching Circuit.
Fig. 3-4	Effect of Diode Gates on signal path (simplified Vertical Switching diagram). Conditions shown for CH 1 position of Vertical Mode switch.
Fig. 3-6	Detailed block diagram of the A Sweep Generator.
Fig. 3-7	Detailed block diagram of the Horizontal Amplifier.
Fig. 3-8	Detailed block diagram of the CRT and Z-Axis circuits.
Fig. 3-9	Detailed block diagram of the Calibrator circuit.
Fig. 3-10	Detailed block diagram of the Trigger View Amplifier.
Fig. 3-11	Detailed block diagram of the Low Voltage Power Supply.
Fig. 3-12	Foldover circuit action.
Fig. 4-1	Removing the wrap around cabinet.
Fig. 4-2	Color codes.

LIST OF TABLES

	Page		Page		
2-1	REGULATING RANGES	2-1	6-1	ADJUSTMENT INTERACTIONS	6-2
3-1	GAIN SWITCHING AND ATTENUATION	3-4	6-2	TEST EQUIPMENT REQUIRED	6-3
5-1	DEFLECTION FACTOR ACCURACY	5-5	6-3	LOW VOLTAGE POWER SUPPLY LIMITS	6-8
5-2	LOW FREQUENCY COMPENSATION SETUP	5-5	6-4	TYPICAL LOW VOLTAGE POWER SUPPLY RIPPLE	6-9
5-3	A AND B TIMING ACCURACY	5-10	6-5	VERTICAL DEFLECTION FACTOR ACCURACY	6-16
5-4	DELAY OR DIFFERENTIAL TIME ACCURACY	5-11	6-6	A AND B TIMING ACCURACY	6-39
			6-7	A AND B MAGNIFIED ACCURACY	6-39
			6-8	DIFFERENTIAL TIME ACCURACY	6-40

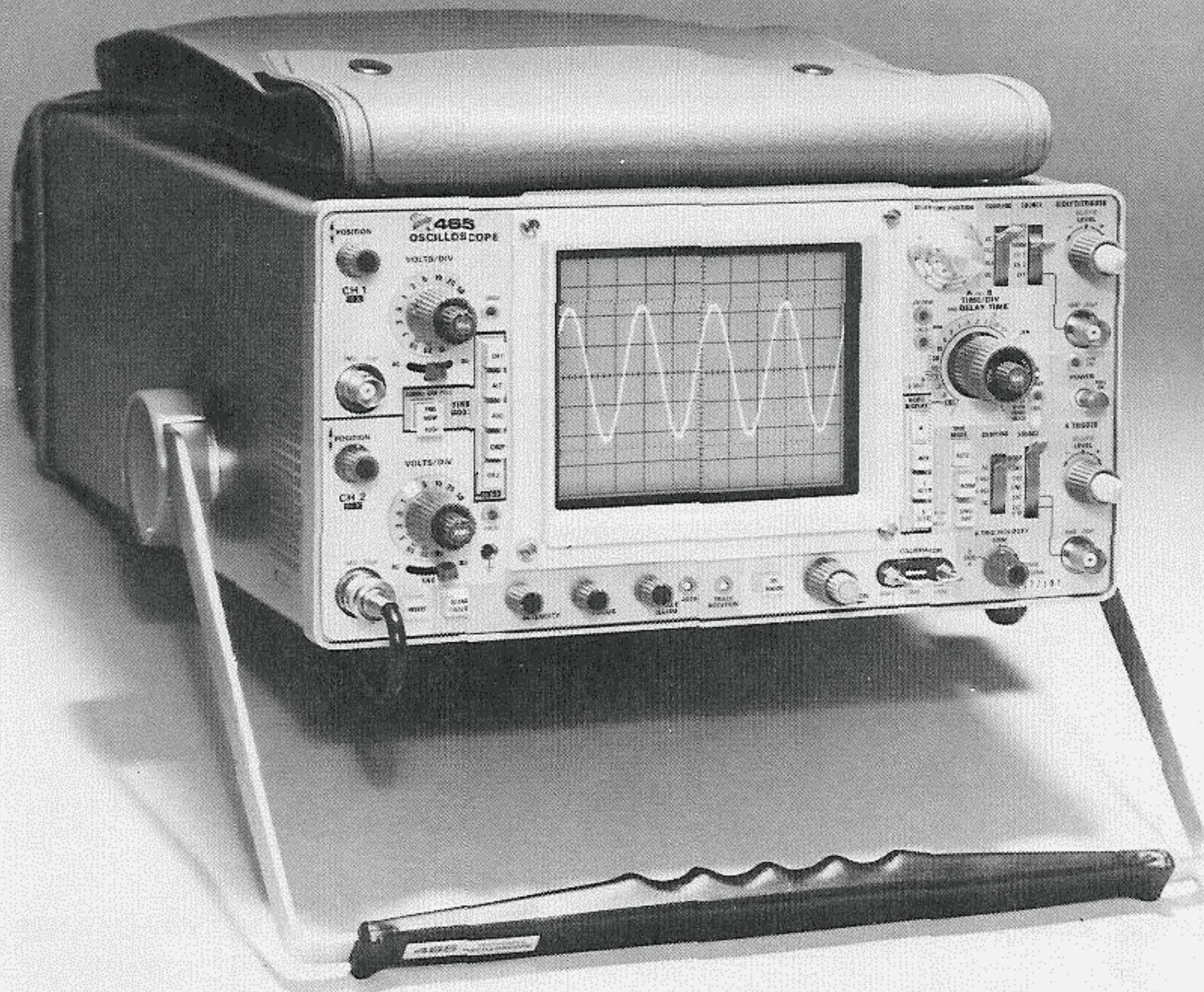

Fig. 1-1. 465 Oscilloscope.

SPECIFICATIONS

Introduction

The 465 Oscilloscope is a wide-band, portable oscilloscope designed to operate in a wide range of environmental conditions. The instrument is light in weight and compact of design for ease of transportation, yet capable of performance necessary for accurate high-frequency measurements. The dual-channel dc-to-100 megahertz vertical deflection system provides calibrated deflection factors from 5 millivolts to 5 volts/division. The bandwidth limiting switch reduces interference from signals above about 20 megahertz for viewing low-frequency, low-level signals.

The trigger circuits provide stable sweep triggering to beyond the bandwidth of the vertical deflection system. Separate controls are provided to select the desired mode of triggering for the A and B sweeps. The A sweep can be operated in one of three modes: automatic triggering, normal triggering, or single sweep. A variable trigger holdoff control provides the ability for A sweep to trigger stably on aperiodic signals or complex digital words. The horizontal deflection system has calibrated sweep rates from 0.5 second to 0.05 microsecond/division. A X10 magnifier increases each sweep rate by a factor of 10 to provide a maximum sweep rate of 5 nanoseconds/division in the 0.05 μ s position. The delayed and mixed sweep features allow the start of the B sweep to be delayed a selected amount from the start of A sweep to provide accurate relative-time measurements. Calibrated X-Y measurements can be made with Channel 2 providing the vertical deflection and Channel 1 providing the horizontal deflection (TIME/DIV switch fully counterclockwise and VERT MODE switch to CH 2). The regulated dc power supplies ensure that instrument performance is not affected by variations in line voltage and frequency. Maximum power consumption of the instrument is approximately 75 watts.

The following instrument specifications apply over an ambient temperature range of -15°C to $+55^{\circ}\text{C}$ unless otherwise specified. Warm-up time for specified accuracies is 20 minutes. The calibration procedure given in section 6, if performed completely, will allow an instrument to meet the electrical characteristics listed below.

VERTICAL DEFLECTION SYSTEM

Deflection Factor

Calibrated range is from 5 millivolts to 5 volts/division in 10 steps in a 1-2-5 sequence. Accuracy is within 3%. Uncalibrated VAR control provides deflection factors continuously variable between the calibrated settings and extends deflection factor to at least 12.5 volts/division in the 5 VOLTS/DIV position.

Frequency Response

Bandwidth in both Channel 1 and Channel 2 is dc to at least 100 megahertz from -15°C to $+40^{\circ}\text{C}$ and dc to at least 85 megahertz from $+40^{\circ}\text{C}$ to $+55^{\circ}\text{C}$. Risetime is 3.5 nanoseconds or less from 0°C to $+40^{\circ}\text{C}$ and 4.2 nanoseconds or less from $+40^{\circ}\text{C}$ to $+55^{\circ}\text{C}$. The ac-coupled lower -3 dB point is 10 hertz or less (1 hertz or less when using a 10X probe). Vertical system bandwidth with the BW LIMIT pushbutton pulled is approximately 20 megahertz.

Chopped Mode Repetition Rate

Approximately 250 kilohertz.

Input Resistance And Capacitance

One megohm within 2% paralleled by approximately 20 picofarads.

Maximum Input Voltage

Dc coupled: 250 V (dc + peak ac) or 500 V p-p ac at 1 kHz or less.

Ac coupled: 500 V (dc + peak ac) or 500 V p-p ac at 1 kHz or less.

Cascaded Operation (CH 1 VERT SIGNAL OUT Connected to CH 2 OR Y)

Bandwidth is dc to at least 50 MHz with a sensitivity of at least 1 millivolt/division.

TRIGGERING

Sensitivity

DC Coupled: 0.3 division internal or 50 millivolts external from dc to 25 megahertz, increasing to 1.5 divisions internal or 150 millivolts external at 100 megahertz.

AC Coupled: 0.3 division internal or 50 millivolts external from 60 hertz to 25 megahertz, increasing to 1.5 divisions internal or 150 millivolts external at 100 megahertz. Attenuates all signals below about 60 hertz.

LF REJ Coupled: 0.5 division internal or 100 millivolts external from 50 kilohertz to 25 megahertz, increasing to 1.5 divisions internal or 300 millivolts external at

Specifications—465 Service (SN B250000 & up)

100 megahertz. Blocks dc and attenuates all signals below about 50 kilohertz.

HF REJ Coupled: 0.5 division internal or 100 millivolts external from 60 hertz to 50 kilohertz. Blocks dc and attenuates all signals below about 60 hertz and above about 50 kilohertz.

Trigger Jitter

0.5 nanosecond or less at 5 nanoseconds/division with 100 megahertz applied (X10 MAG on).

External Trigger Input

Maximum input voltage is 250 volts (dc + peak ac) or 250 volts peak to peak ac (1 kilohertz or less). Input resistance is 1 megohm within 10%.

Level Range

EXT: At least + and -2 volts, 4 volts peak to peak.

EXT ÷10: At least + and -20 volts, 40 volts peak to peak.

HORIZONTAL DEFLECTION SYSTEM

Calibrated Sweep Range

A Sweep: From 0.5 second/division to 0.05 microsecond/division in 22 steps in a 1-2-5 sequence. X10 MAG extends maximum sweep rate to 5 nanoseconds/division.

B Sweep: From 50 milliseconds/division to 0.05 microsecond/division in 19 steps in a 1-2-5 sequence. X10 MAG extends maximum sweep rate to 5 nanoseconds/division.

Calibrated Sweep Accuracy

Unmagnified sweep accuracy is within 2% from +20°C to +30°C (+68°F to +86°F) and within 3% from -15°C to +20°C and +30°C to +55°C (+5°F to +68°F and +86°F to +131°F). For the same temperature ranges, magnified sweep accuracy is within 3% and within 4% respectively. Exclude the first and last 50 nanoseconds of the 5 nanoseconds, 10 nanoseconds, and 20 nanoseconds magnified sweep rates. Accuracy specifications apply over full 10 divisions unless otherwise specified.

Sweep accuracy, over any 2 or less division portion of the sweep, is within 5%. Exclude the first and last magnified divisions of the 5 nanosecond and

10 nanosecond/division magnified sweep rates. Also exclude the first and last 50 nanoseconds of the 5, 10, and 20 nanoseconds/division sweep rates.

Mixed sweep accuracy is within 2% plus the measured A sweep error when viewing the A sweep portion only. The B sweep portion retains its normal accuracy.

A Time/Division Variable Range

Provides continuously variable (Uncalibrated) sweep rates between the calibrated settings of the A TIME/DIV switch. Extends the slowest A sweep rate to at least 1.25 seconds/division.

A Trigger Holdoff

Increases A sweep holdoff time by at least a factor of 10.

Delay Time And Differential Time Measurement Accuracy

	+10°C to +35°C (+50°F to +95°F)	-15°C to +55°C (+5°F to +131°F)
Over 1 Or More Major Dial Division	±1%	±2.5%
Over Less Than 1 Major Dial Division	±0.01 Major Dial Division	±0.03 Major Dial Division

Delay or Differential Time Jitter

Within 0.002% (less than one part in 50,000) of the maximum available delay time when operating on power line frequencies other than 50 hertz.

Within 0.005% (less than one part in 20,000) of the maximum available delay time when operating on 50 hertz power line frequency.

Maximum available delay time is 10 times the setting of the A TIME/DIV switch.

Calibrated Delay Time (A VAR set to calibrated position)

Continuous from 5 seconds to 0.2 microsecond.

X-Y OPERATION

Sensitivity

Same as vertical deflection system.

X Axis deflection accuracy within 4%.

Variable Range

Same as vertical deflection system.

X-Axis Bandwidth

Dc to at least 4 megahertz.

Y-Axis Bandwidth

Same as vertical deflection system.

Input Resistance

Same as vertical deflection system.

Input Capacitance

Same as vertical deflection system.

Maximum Usable Input Voltage

Same as vertical deflection system.

CALIBRATOR**Output**

An approximate 1 kilohertz, 30 milliampere (within 2%), 300 millivolt (within 1%), square-wave signal.

Z AXIS INPUT**Sensitivity**

A 5-volt peak to peak signal causes noticeable modulation at normal intensity.

Usable Frequency Range

From dc to 50 megahertz.

SIGNAL OUTPUTS**Ch 1 Vertical**

Output voltage is at least 50 millivolts/division into a 1 megohm load (at least 25 millivolts/division into a 50 ohm load).

Bandwidth is from dc to at least 50 megahertz into a 50 ohm load.

Output dc level is approximately zero volts.

Specifications—465 Service (SN B250000 & up)**A and B +Gate**

Output voltage is approximately 5.5 volts, positive-going.

POWER SOURCE**Line Voltages**

110, 115, 120, 220, 230, or 240 Volts ac (all within 10%), depending on the settings of the Line Voltage Selector switch and the Regulating Range Selector assembly, with a line frequency of 48 to 440 hertz. Maximum power consumption is 75 watts at 115 volts ac, 60 hertz.

CATHODE-RAY TUBE (CRT)**Graticule Area**

Eight by 10 centimeters.

Phosphor

P31 is the standard phosphor with P11 offered as an option.

SUPPLEMENTAL INFORMATION*NOTE*

The following supplemental information represents limits that, when met, ensure optimum instrument operation. They are, however, not instrument specifications but are intended to be used only as maintenance or operational aids.

VERTICAL DEFLECTION SYSTEM**Low—Frequency Linearity**

There should be no more than 0.1 division of compression or expansion of a 2-division signal, at center screen, when the signal is positioned to the upper and lower extremes of the crt graticule area.

Bandwidth Limiter Switch

The -3 dB point should be between 15 and 25 megahertz with the 20 MHz BW switch pulled (yellow showing).

Step Response Aberrations

Aberrations on a positive going 5 division step should be +3%, -3% or less not to exceed 3% peak-to-peak on

Specifications—465 Service (SN B250000 & up)

all ranges except at 5 VOLTS/DIV. Aberrations at 5 VOLTS/DIV should be +4%, -4% or less not to exceed 4% peak-to-peak. Position effect should cause aberrations to be no more than +5%, -5% not to exceed 5% peak-to-peak.

Common-Mode Rejection Ratio (CMRR)

At least 10:1 at 20 megahertz for common mode signals of 6 divisions or less with vertical gain adjusted for best cmrr at 50 kilohertz.

Step Attenuator Balance

Adjustable to 0.2 division or less of trace shift when switching between adjacent deflection factors.

Trace Shift as Variable is Rotated

Adjustable to 1 division or less.

Invert Trace Shift

Two divisions or less when switching from normal to inverted.

Input Gate Current

0.5 nanoampere or less (0.1 division of deflection at 5 millivolts/division) from +20°C to +30°C. Four nanoamperes or less (0.8 division of deflection at 5 millivolts/division) from -15°C to +55°C.

Channel Isolation

At least 100:1 at 25 megahertz.

Position Range

Twelve divisions up and 12 divisions down from graticule center.

TRIGGERING

External Trigger Input Capacitance

Twenty picofarads within 30%.

HORIZONTAL DEFLECTION SYSTEM

A Sweep Length

10.5 to 11.5 divisions.

Magnifier Registration

There should be 0.2 division or less difference at graticule center when switching from MAG on to MAG off.

Position Range

Should be able to position the start of the sweep to the right of graticule center, and the end of the sweep to the left of graticule center.

Phase Difference Between X And Y Axes Amplifiers

Typically 3° or less from dc to 50 kilohertz.

CALIBRATOR

Repetition Rate

Repetition rate accuracy is 1 kilohertz within 25%.

Output Resistance

Approximately 9.4 ohms.

EXTERNAL Z AXIS INPUT

Voltages applied to the EXT Z AXIS INPUT connector should be limited to less than 100 volts (dc + peak ac) or 100 volts peak to peak ac at 1 kilohertz or less.

OUTPUT RESISTANCES

Output resistance of the CH 1 VERT SIG OUT connector is approximately 50 ohms.

Output resistance of A+ and B+ GATE outputs is approximately 500 ohms.

CATHODE-RAY TUBE

Resolution

Typically at least 15 lines/division horizontally and vertically.

Geometry

0.1 division or less of tilt or bowing.

Raster Distortion

0.1 division or less.

Nominal Accelerating Potential

Approximately 18,500 volts.

OPERATING INFORMATION

Introduction

This section of the manual is intended to allow the operator to become familiar with the instrument power requirements, functions of controls and connectors, and how to obtain a few basic displays. For more complete operating information, refer to the 465 Operators Handbook.

Instrument Repackaging

If this instrument is to be shipped for long distances by commercial means of transportation, it is recommended that it be repackaged in the original manner for maximum protection. The original shipping carton can be saved and used for this purpose. The Mechanical Parts List illustrates how to repackage the 465 and gives the part number for the packaging components. New shipping cartons can be obtained from Tektronix, Inc. Contact your local TEKTRONIX Field Office or representative.

Operating Voltage

WARNING

This instrument is designed for operation from a power source with its neutral at or near earth (ground) potential with a separate safety-earth conductor. It is not intended for operation from two phases of a multi-phase system, or across the legs of a single-phase three-wire system.

This instrument can be operated from either a 115-volt or 230-volt nominal line voltage source, 48 to 440 hertz. The Line Voltage Selector switch on the right side panel converts the instrument from one nominal operating voltage to the other. The Regulating Range Selector assembly on the instrument rear panel selects one of three regulating ranges for each nominal line voltage; it also contains the line fuse for overload protection. To select the correct nominal line voltage and regulating range, proceed as follows:

1. Disconnect the instrument from the power source.

2. To convert from 115-volts nominal to 230-volts nominal line voltage, set the selector switch to the 230 volts position (toward the rear of the instrument). Change the line-cord plug to match the power source or use a 115-to-230 volt adapter. Check for correct fuse for the line voltage selected (see Table 2-1).

NOTE

The power cord on Tektronix instruments may conform to either of the following two electrical codes:

Conductor	USA (NEC) & Canada	IEC
Line	Black	Brown
Neutral	White	Light Blue*
Safety-Earth	Green w/yellow stripe	Green w/yellow stripe

*Tinned copper conductor.

3. To change regulating ranges, loosen the 2 captive screws which hold the cover onto the Regulating Range Selector assembly, then pull to remove the cover.

4. Pull out the range selector switch bar (see Fig. 2-1). Slide the bar to the desired position and plug it back in. Select a range which is centered about the average line voltage to which the instrument is to be connected (see Table 2-1).

TABLE 2-1
REGULATING RANGES

Range Selector Switch Position	Regulating Range	
	115 V Nominal	230 V Nominal
Lo (switch bar in bottom holes)	99 to 121 V	198 to 242 V
M (switch bar in middle holes)	104 to 126 V	208 to 252 V
Hi (switch bar in top holes)	108 to 132 V	216 to 264 V
Fuse Size	1.5 A 3AG Fast-blow	0.75 A 3AG Fast-blow

5. Re-install the cover and tighten the 2 captive screws.

6. Before applying power to the instrument, check that the line voltage selector switch and the indicating tab on the Regulating Range Selector assembly are in the correct position for the desired nominal line voltage and regulating range.

CAUTION

This instrument may be damaged if operated with the line voltage selector switch or the Regulating Range Selector assembly set to incorrect positions for the line voltage applied, or if the wrong line fuse is used.



Fig. 2-1. Power supply regulating range selector.

The 465 is designed to be used with a three-wire ac power system. If a 3 to 2 wire adapter is used to connect this instrument to a 2 wire ac power system, be sure to connect the ground lead of the adapter to earth (ground). Failure to complete the ground system may allow the chassis of this instrument to be elevated above ground potential and pose a shock hazard.

The feet on the rear panel provide a convenient cord wrap to store the power cord when not in use.

CONTROLS AND CONNECTORS

Introduction

The major controls and connectors for operation of the 465 are located on the front panel of the instrument. A few auxiliary functions are provided on the rear panel. Fig. 2-2 shows the front and rear panels of the 465. A brief description of each control and connector is given here. More detailed operating information is given in the 465 Oscilloscope Operators Manual.

Cathode-Ray Tube (CRT) and Display

1. BEAM FINDER Compresses the display to within the graticule area, independently of display position or applied signals.
2. INTENSITY Controls brightness of the display.

3. FOCUS Provides adjustment for optimum display definition.
4. SCALE ILLUM Controls graticule brightness.
5. ASTIG Screwdriver adjustment used in conjunction with the FOCUS control to obtain a well-defined display. Does not require readjustment in normal use.
6. TRACE ROTATION Screwdriver adjustment to align the trace with the horizontal graticule lines.

Vertical Deflection System (Channel 1 & Channel 2)

7. POSITION Controls the vertical position of the trace. In the X-Y mode of operation, the Ch 2 control positions on the Y-axis (vertically) and the Horizontal POSITION control positions on the X-axis (horizontally).
8. CH 1 OR X Input connector for Channel 1 deflection signals or X-axis deflection in the X-Y mode of operation.
9. CH 2 OR Y Input connector for Channel 2 deflection signals or Y-axis deflection in the X-Y mode of operation.
10. VOLTS/DIV Selects vertical deflection factor in a 1-2-5 sequence (VAR control must be in the calibrated detent for the indicated deflection factor).
11. VAR Provides continuously variable uncalibrated deflection factors between the calibrated settings of the VOLTS/DIV switch.
12. UNCAL Light indicates that the VAR control is not in the calibrated position.
13. Input Coupling Selects the method of coupling signal to the input of the Vertical Amplifier.
 - AC:** Signal is capacitively coupled to the Vertical Amplifier. Dc component of signal is blocked. Low-frequency limit (lower -3 dB point) is about 10 hertz.
 - GND:** Input signal is removed and the input circuit is grounded. Does not ground the input signal.
 - DC:** All components of the input signal are passed to the Vertical Amplifier.

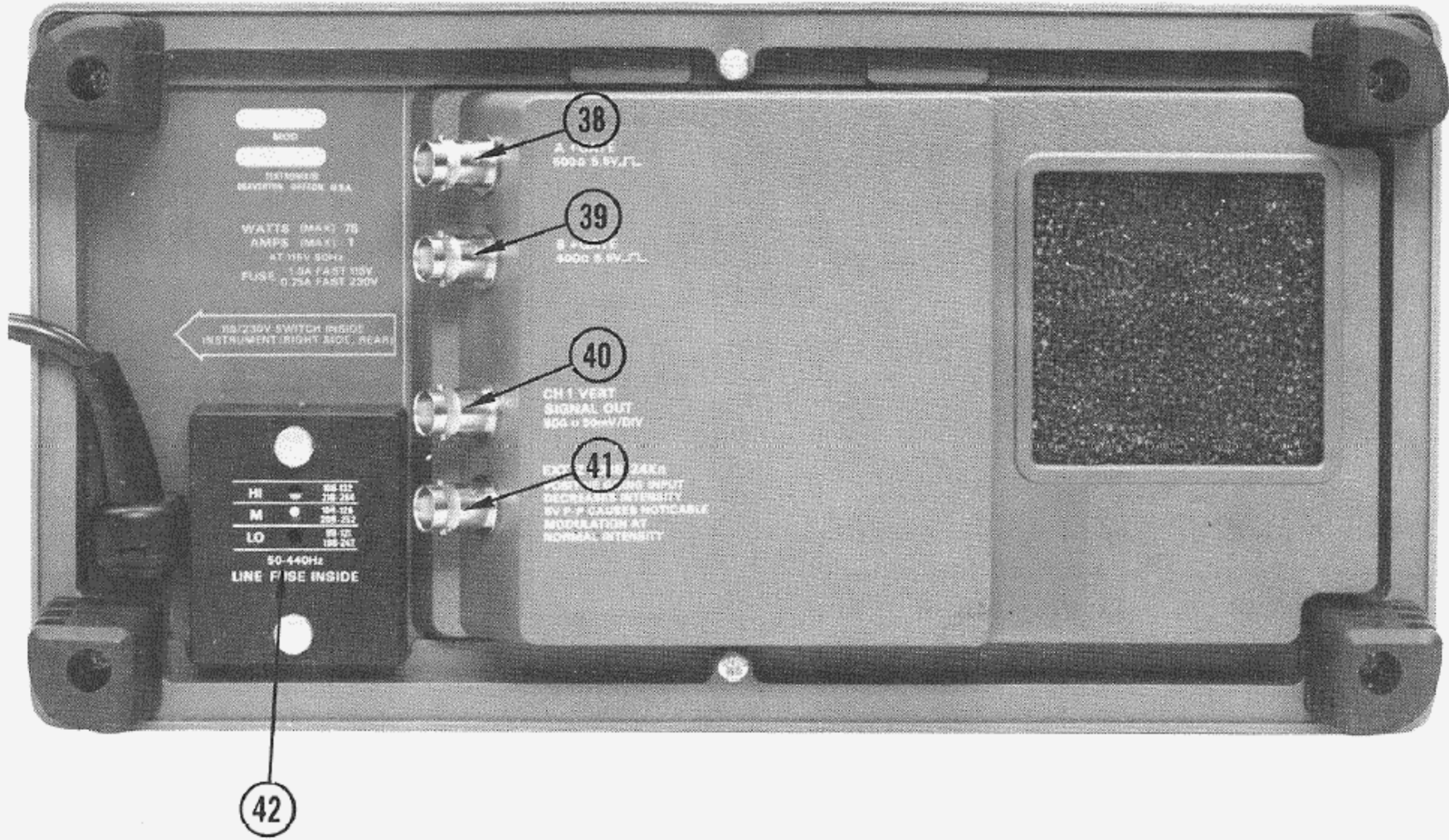
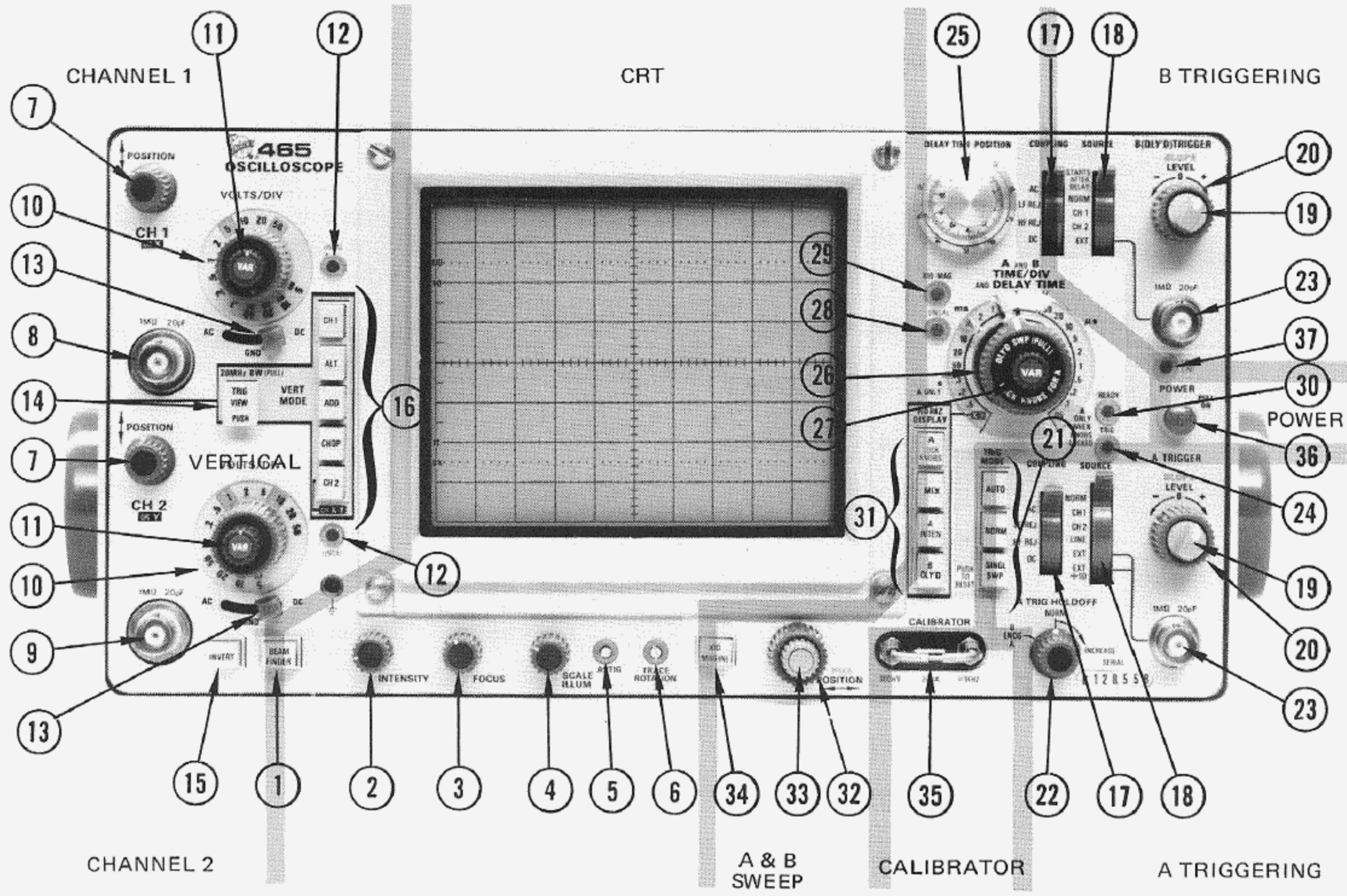

Fig. 2-2. Front and rear panel controls and connectors.

1861-23

Operating Information—465 Service (SN B250000 & up)

14. 20 MHz BW/
TRIG VIEW Dual-purpose switch that, when pulled out, limits the bandwidth of the complete Vertical Deflection System to approximately 20 megahertz, or when pressed causes signal present in A Trigger Generator circuit to be displayed on the CRT.
15. INVERT Pushbutton switch that inverts the Channel 2 display.
16. VERT MODE **CH 1:** Displays Channel 1 only.
- ALT:** Dual-trace display of signals on both channels. Display is switched between channels at the end of each sweep.
- ADD:** Signals applied to the CH 1 OR X and CH 2 OR Y connectors are algebraically added and the sum is displayed on the CRT. The INVERT switch in Channel 2 allows the display to be CH 1 + CH 2 or CH 1 - CH 2.
- CHOP:** Dual-trace display of signals on both channels. Display is switched between channels at an approximate repetition rate of 250 kilohertz.
- CH 2 OR X-Y:** Displays Channel 2 only. Must be pushed when operating in X-Y mode.
- A and B Triggering (both where applicable)**
17. COUPLING Determines the method used to couple signal to input of trigger circuits.
- AC:** Rejects dc and attenuates signals below about 60 hertz. Accepts signals above about 60 hertz.
- LF REJ:** Rejects dc and attenuates signals below about 50 kilohertz. Accepts signals above about 50 kilohertz.
- HF REJ:** Accepts signals between 60 hertz and 50 kilohertz. Rejects dc and attenuates all signals outside the above range.
- DC:** Accepts all trigger signals from dc to 100 megahertz or greater.
18. SOURCE Selects source of trigger signal.
- NORM:** Internal trigger signal obtained from Vertical Deflection System. Actual source is signal(s) displayed on crt.
- CH 1:** A sample of the signal connected to the CH 1 OR X input connector is used as a trigger signal.
- CH 2:** A sample of the signal connected to the CH 2 OR Y input connector is used as a trigger signal.
- EXT:** Trigger signal is obtained from signal connected to the External Trigger Input connector.
- EXT ÷10 (A trigger circuit only):** External trigger signal is attenuated by a factor of 10.
- STARTS AFTER DELAY (B trigger circuit only):** B sweep starts immediately after the delay time selected by the DELAY-TIME POSITION dial and the DELAY-TIME switch.
- LINE (A trigger circuit only):** Trigger signal is obtained from a sample of the line voltage applied to the instrument.
19. SLOPE Selects the slope of the trigger signal which starts the sweep.
- + : Sweep can be triggered from the positive-going portion of the trigger signal.
- : Sweep can be triggered from the negative-going portion of the trigger signal.
20. LEVEL Selects the amplitude point on the trigger signal at which the sweep is triggered.
21. A TRIG MODE Determines the operating mode for the A Trigger Circuit.
- AUTO:** With the proper trigger control settings, A Sweep can be initiated by signals that have repetition rates above about 20 hertz and are within the frequency range selected by the

COUPLING switch. In the absence of an adequate trigger signal or when the trigger controls are misadjusted, the sweep free-runs to produce a reference trace.

NORM: With the proper trigger control settings, A Sweep can be initiated by signals that are within the frequency range selected by the COUPLING switch. In the absence of an adequate trigger signal or when the trigger controls are misadjusted, there is no trace.

SINGL SWP: After a sweep is displayed, further sweeps cannot be presented until the SINGL SWP pushbutton is pressed again. The display is triggered the same as for NORM operation using the A Triggering controls.

22. A TRIG HOLD-OFF

Provides control of holdoff time between sweeps to obtain stable displays when triggering on aperiodic signals (such as complex digital words). Variable can increase holdoff time up to at least 10 times the holdoff time of the NORM position. In the B ENDS A position (fully clockwise), the A sweep is reset at the end of the B sweep to provide the fastest possible sweep repetition rate for delayed sweep presentations.

23. External Trigger

Input connectors for external trigger signals.

24. TRIG

Light that indicates A sweep is triggered.

A and B Sweep

25. DELAY-TIME POSITION

Provides variable sweep delay between 0.20 and 10.20 times the delay time indicated by the DELAY TIME switch.

26. A AND B TIME/DIV

A TIME/DIV switch (clear plastic outer flange) selects the sweep rate of the A sweep circuit and selects the basic delay time (to be multiplied by DELAY-TIME POSITION dial setting) for delayed-sweep operation. B TIME/DIV switch (inner dark knob) selects sweep rate of the B sweep circuit for delayed sweep operation only. VAR control must be in calibrated detent for calibrated A sweep rates.

27. VAR

Provides continuously variable A sweep rates between the calibrated settings of the A TIME/DIV switch. The A sweep rate is calibrated when the VAR control is fully clockwise into the calibrated detent.

28. UNCAL

Light that indicates when the VAR TIME/DIV control is out of the calibrated detent and the horizontal sweep rate is uncalibrated.

29. X10 MAG Indicator

Light that indicates when the X10 MAG is turned on.

30. READY

Light that indicates that A Sweep has been prepared to present a single sweep upon receipt of an adequate trigger signal.

31. HORIZ DISPLAY

Selects the horizontal mode of operation.

A: Horizontal deflection provided by A Sweep. B Sweep inoperative.

MIX: The first part of the horizontal sweep is displayed at a rate set by the A TIME/DIV switch and the latter part of the sweep at a rate set by the B TIME/DIV switch. Relative amounts of the display allocated to each of the two rates are determined by the setting of the DELAY-TIME POSITION dial.

A INTEN: Displayed sweep rate determined by the A TIME/DIV switch. An intensified portion appears on the display during the B sweep time. This switch position provides a check of the duration and position of the B sweep (delayed sweep) with respect to the delaying sweep (A).

B DLYD: Sweep rate determined by the B TIME/DIV switch with the delay time determined by the setting of the DELAY TIME (A TIME/DIV) switch and the DELAY-TIME POSITION dial.

32. Horizontal

Positions the display horizontally.

33. FINE

Provides fine horizontal positioning.

34. X10 MAG

Increases the displayed sweep rate by a factor of 10.

Operating Information—465 Service (SN B250000 & up)

Calibrator and Power

35. CALIBRATOR A combination current loop and square-wave voltage output device. Provides a 30 milliamper square-wave current, 300 millivolt square-wave voltage signal with a repetition rate of approximately 1 kilohertz.
36. POWER Turns instrument power on and off.
37. LOW LINE Light that indicates the applied line voltage is below the lower limit of the regulating range selected by the Regulating Range Selector assembly.

Rear Panel

38. A +GATE Output connector providing a positive-going rectangular pulse coincident with the A sweep time.
39. B +GATE Output connector providing a positive-going rectangular pulse coincident with the B sweep time.
40. CH 1 VERT Output connector providing a sample of the signal applied to the CH 1 input connector.
41. EXT Z AXIS Input connector for intensity modulation of the crt display.
42. Regulating Range Selector Selects the regulating range of the internal power supplies (low, medium, high; determined by specific line voltage applied to instrument).

OBTAINING BASIC DISPLAYS

Introduction

The following instructions will allow the operator who is unfamiliar with the operation of the 465 to obtain the basic displays commonly used. Before proceeding with these instructions, preset the instrument controls as follows:

Vertical Controls

VERT MODE Switch	CH 1
VOLTS/DIV Switches	Proper position determined by amplitude of signal to be applied.

VOLTS/DIV VAR Controls	Calibrated detent
Input Coupling Switches	AC
Vertical POSITION Controls	Midrange
20 MHz BW Switch	Not limited
INVERT Switch	Button out
INTENSITY Control	Fully counterclockwise
FOCUS Control	Midrange
SCALE ILLUM Control	Midrange

Trigger Controls (both A and B if applicable)

SLOPE Switch	+
LEVEL Control	0
SOURCE Switch	NORM
COUPLING Switch	AC
TRIG MODE Switch	AUTO
A TRIG HOLDOFF Control	NORM

Horizontal Sweep Controls

TIME/DIV Switches	Locked together at 1 ms
A TIME/DIV VAR	Calibrated detent
HORIZ DISPLAY Switch	A
X10 MAG Switch	Off (button out)
POSITION Control	Midrange

Normal Sweep Display

1. Set the POWER switch to on (button out). Allow several minutes for instrument warmup.

2. Connect the external signal to the CH 1 input connector.

3. Advance the INTENSITY control until the display is visible. If the display is not visible with the INTENSITY control at midrange, press the BEAM FINDER pushbutton and adjust the CH 1 VOLTS/DIV switch until the display is reduced in size vertically. Then, center the compressed display with the vertical and horizontal POSITION controls, and release the BEAM FINDER pushbutton.

4. Set the CH 1 VOLTS/DIV switch and CH 1 POSITION control for a display which remains in the display area vertically.

5. Adjust the A Trigger LEVEL control for a stable display.

6. Set the A TIME/DIV switch and the horizontal POSITION control for a display which remains in the display area horizontally.

Magnified Sweep Display

1. Preset the instrument controls and follow steps 1 through 6 for obtaining a Normal Sweep Display.

2. Adjust the horizontal POSITION control to move the area to be magnified to within the center graticule division of the crt (0.5 division on each side of the center vertical graticule line). If necessary, change the TIME/DIV switch setting so the complete area to be magnified is within the center division.

3. Set the X10 MAG switch to the on position (button in) and adjust the horizontal POSITION and FINE controls for precise positioning of the magnified display.

Delayed Sweep Displays

1. Preset the instrument controls and follow steps 1 through 6 for obtaining a Normal Sweep Display.

2. Set the HORIZ DISPLAY switch to A INT and the B Trigger SOURCE switch to STARTS AFTER DELAY.

3. Pull out the B TIME/DIV switch knob and turn clockwise so the intensified zone on the display is the desired length. Adjust the INTENSITY control to achieve the desired display brightness.

4. Adjust the DELAY-TIME POSITION dial to position the intensified zone to the portion of the display to be delayed.

5. Set the HORIZ DISPLAY switch to B DLYD. The intensified zone on the display noted in step 3 is now being displayed in delay form. The delayed sweep rate is indicated by the dot on the B TIME/DIV switch knob.

6. For a delayed sweep display that will exhibit less jitter, set the B Trigger SOURCE switch to the same position as the A Trigger SOURCE switch and adjust the B Trigger LEVEL control for a stable display. If the A Trigger

SOURCE switch is in the LINE position, a sample of the line voltage will have to be supplied to the B Trigger circuit through the B EXT trigger input with the B SOURCE switch in the EXT position.

Mixed Sweep Displays

1. Preset the instrument controls and follow steps 1 through 6 for obtaining a Normal Sweep Display.

2. Pull out on the B TIME/DIV switch knob and turn clockwise to the desired sweep rate. Adjust the INTENSITY control to achieve the desired display for brightness.

3. Set the HORIZ DISPLAY switch to MIX. The CRT display now contains more than one time factor on the horizontal axis. The left portion of the display is at the A Time Base sweep rate and the right part is at the B Time Base sweep rate. The start of the B Time Base portion of the display can be changed by adjusting the DELAY-TIME POSITION control.

X-Y Display

1. Preset the instrument controls and turn the instrument power on. Allow several minutes for instrument warm-up.

2. Set the TIME/DIV switch to X-Y and the VERT MODE to CH 2. Apply the vertical signal to the CH 2 or Y input connector and the horizontal signal to the CH 1 or X input connector. The CH 2 POSITION control will provide vertical positioning and the Horizontal POSITION control will provide horizontal positioning.

3. Advance the INTENSITY control until the display is visible. If the display is not visible with the INTENSITY control at midrange, press the BEAM FINDER pushbutton and adjust the CH 1 and CH 2 VOLTS/DIV switches until the display is reduced in size both vertically and horizontally. Then, center the compressed display with the CH 2 POSITION and horizontal POSITION controls, and release the BEAM FINDER pushbutton. Adjust the FOCUS control for a well-defined display.

CIRCUIT DESCRIPTION

Introduction

This section of the manual contains a description of the circuitry used in the 465 Oscilloscope. The description begins with a discussion of the instrument, using the basic block diagram shown in Fig. 3-1. Then, each circuit is described in detail using detailed block diagrams to show the interconnections between the stages in each major circuit and the relationship of the front panel controls to the individual stages.

A complete block diagram is located in the Diagrams Section at the back of this manual. This block diagram shows the overall relationship between all of the circuits. Complete schematics of each circuit are also given in the Diagrams Section. Refer to these diagrams throughout the following circuit description for electrical values and relationships.

Digital Logic

Digital logic techniques are used to perform many functions within this instrument. The function and operation of the logic circuits are described using logic symbology and terminology. All logic functions are described using the positive logic convention. Positive logic is a system of notation where the more positive of two levels (HI) is called the true or 1 state; the more negative level (LO) is called the false or 0 state. The HI-LO method of notation is used in this logic description. The specific voltages which constitute a HI or LO state vary between individual devices.

It should be noted that not all of the integrated circuit devices in this instrument are digital logic devices. The function of non-digital devices will be described individually using operating waveforms or other techniques to illustrate their function.

BLOCK DIAGRAM

The following discussion is provided to aid in understanding the overall concept of the 465 Oscilloscope before the individual circuits are discussed in detail. A basic block diagram of the 465 Oscilloscope is shown in Fig. 3-1. Only the basic interconnections between the individual blocks are shown on this diagram. Each block represents a major circuit within the instrument. The number on each block refers to the complete circuit diagram, which is located at the rear of this manual.

Signals to be displayed on the crt are applied to the CH 1 OR X and/or CH 2 OR Y connectors. The input signals are then amplified by the Preamp circuits. Each Preamp circuit includes separate vertical deflection factor, input coupling, balance, gain and variable attenuation controls. A trigger pickoff stage in each Vertical Preamp circuit supplies a sample of the channel signals to the Trigger Generator circuit. A sample of the Channel 1 signal is also supplied to the CH 1 VERT SIGNAL OUT connector on the instrument rear panel. In the X-Y mode of operation the Channel 1 signal is connected to the input of the Horizontal Amplifier circuit to provide the X-axis deflection. The Channel 2 Vertical Preamp circuit contains an invert feature to invert the Channel 2 signal as displayed on the crt. The outputs of both Vertical Preamp circuits are connected to the Vertical Switching circuit. This circuit selects the channel(s) to be displayed. An output signal from this circuit is connected to the Z-Axis Amplifier circuit to blank out the switching transients between channels when in the chopped mode of operation. A trigger pickoff stage at the output of the Vertical Switching circuit provides a sample of the displayed signal(s) to the Trigger Generator circuit.

The output of the Vertical Switching circuit is connected to the Vertical Output Amplifier through the Delay Line. The Vertical Output Amplifier circuit provides the final amplification for the signal before it is connected to

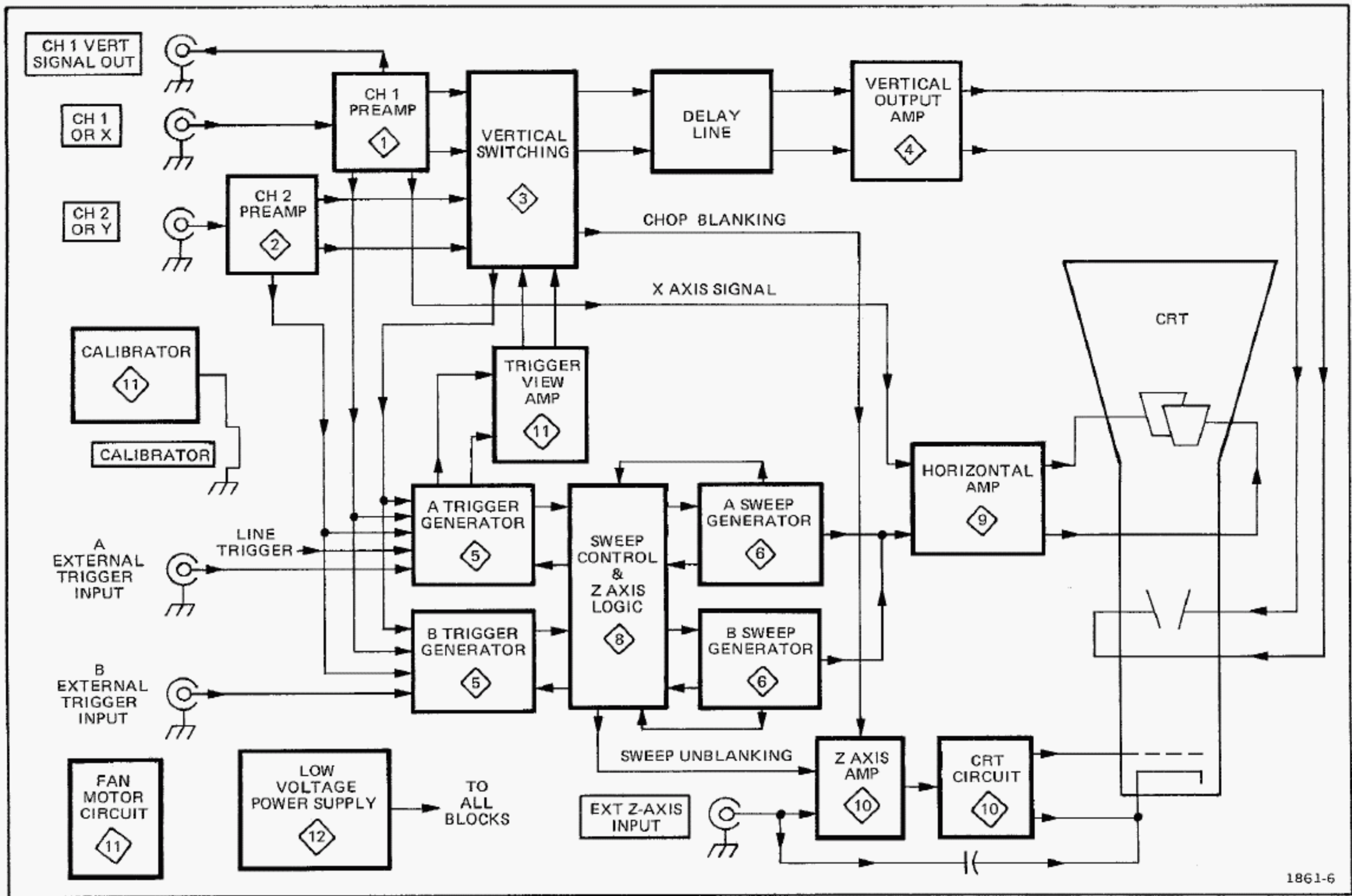

Fig. 3-1. Basic block diagram of the 465.

the vertical deflection plates of the crt. This circuit includes part of the BEAM FINDER switch. This portion, when activated, limits vertical deflection to within the viewing area as an aid in locating off-screen displays.

The A and B Trigger Generator circuits produce an output pulse which initiates the sweep signal produced by the A or B Sweep Generator circuits. The input signal to the A and B Trigger Generator circuits can be individually selected from the Channel 1 signal, Channel 2 signal, the signal(s) displayed on the crt, a signal connected to the external trigger input connectors, or a sample of the line voltage applied to the instrument. Each trigger circuit contains level, slope, coupling and source controls.

The A Sweep Generator circuit, when initiated by the A Trigger Generator circuit, produces a linear sawtooth output signal, the slope of which is controlled by the A TIME/DIV switch. The TRIG MODE switch controls the operating mode of the A Trigger Generator circuit. In the AUTO position, the absence of an adequate trigger signal,

for about 100 milliseconds after the end of holdoff, causes an A Sweep start gate to be generated. In the NORM position, a horizontal sweep is presented only when correctly triggered by an adequate trigger signal. Pushing the SINGL SWP pushbutton allows only one sweep to be initiated. The Z-Axis Logic circuit produces an unblanking gate signal to unblank the crt so that the display can be presented. This gate signal is coincident with the sawtooth produced by the A Sweep Generator circuit. A gate signal, which is also coincident with the sawtooth, is available at the A + GATE connector on the instrument rear panel. The Z-Axis Logic circuit also produces an alternate sync pulse, which is connected to the Vertical Switching circuit. This pulse switches the display between channels at the end of each sweep when the VERT MODE switch is in the ALT position.

The B Sweep Generator circuit is basically the same as the A Sweep Generator circuit. However, this circuit only produces a sawtooth output signal after a delay time determined by the A TIME/DIV switch and the DELAY TIME POSITION dial. If the B Triggering SOURCE switch is set to the STARTS AFTER DELAY position, the B Sweep

Generator begins to produce the sweep immediately following the selected delay time. If the switch is in one of the remaining positions, the B Sweep Generator circuit does not produce a sweep until it receives a trigger pulse occurring after the selected delay time.

The output of either the A or B Sweep Generator is amplified by the Horizontal Amplifier circuit to produce horizontal deflection for the crt, except in the fully counterclockwise (X-Y) position of the TIME/DIV switch. This circuit contains a 10X magnifier to increase the sweep rate 10 times in any A or B TIME/DIV switch position. Other horizontal deflection signals can be connected to the horizontal amplifier by using the X-Y mode of operation. When the TIME/DIV switch is set to X-Y, the X signal is connected to the Horizontal Amplifier circuit through the Channel 1 Vertical Preamp circuit.

The Z-Axis Amplifier circuit determines the crt intensity and blanking. The Z-Axis Amplifier circuit sums the current inputs from the INTENSITY control, Vertical Switching circuit (chopped blanking), Z-Axis Logic circuit (unblanking) and the external Z-AXIS INPUT connector. The output level of the Z-Axis Amplifier circuit controls the trace intensity through the CRT circuit. The CRT circuit provides the voltages and contains the controls necessary for operation of the cathode-ray tube.

The Power Supply circuit provides the low voltage power necessary for operation of this instrument. This voltage is distributed to all of the circuits in the instrument.

The Calibrator circuit produces a square-wave output with accurate voltage and current amplitudes which can be used to check the calibration of the instrument and the compensation of probes. The CALIBRATOR current loop provides an accurate current source for calibration of current measuring probe systems.

CHANNEL 1 PREAMP

Introduction

Input signals for vertical deflection on the crt can be connected to the CH 1 OR X input connector. In the X-Y mode of operation the input signal connected to the CH 1 OR X connector provides the horizontal (X axis) deflection (TIME/DIV switch set to X-Y, VERT MODE switch set to CH 2 OR X-Y). The Channel 1 Preamp circuit provides control of input coupling, vertical deflection factor, gain and dc balance. Fig. 3-2 shows a detailed block diagram of the Channel 1 Preamp circuit. A schematic of this circuit is shown on Diagram 1 at the rear of the manual.

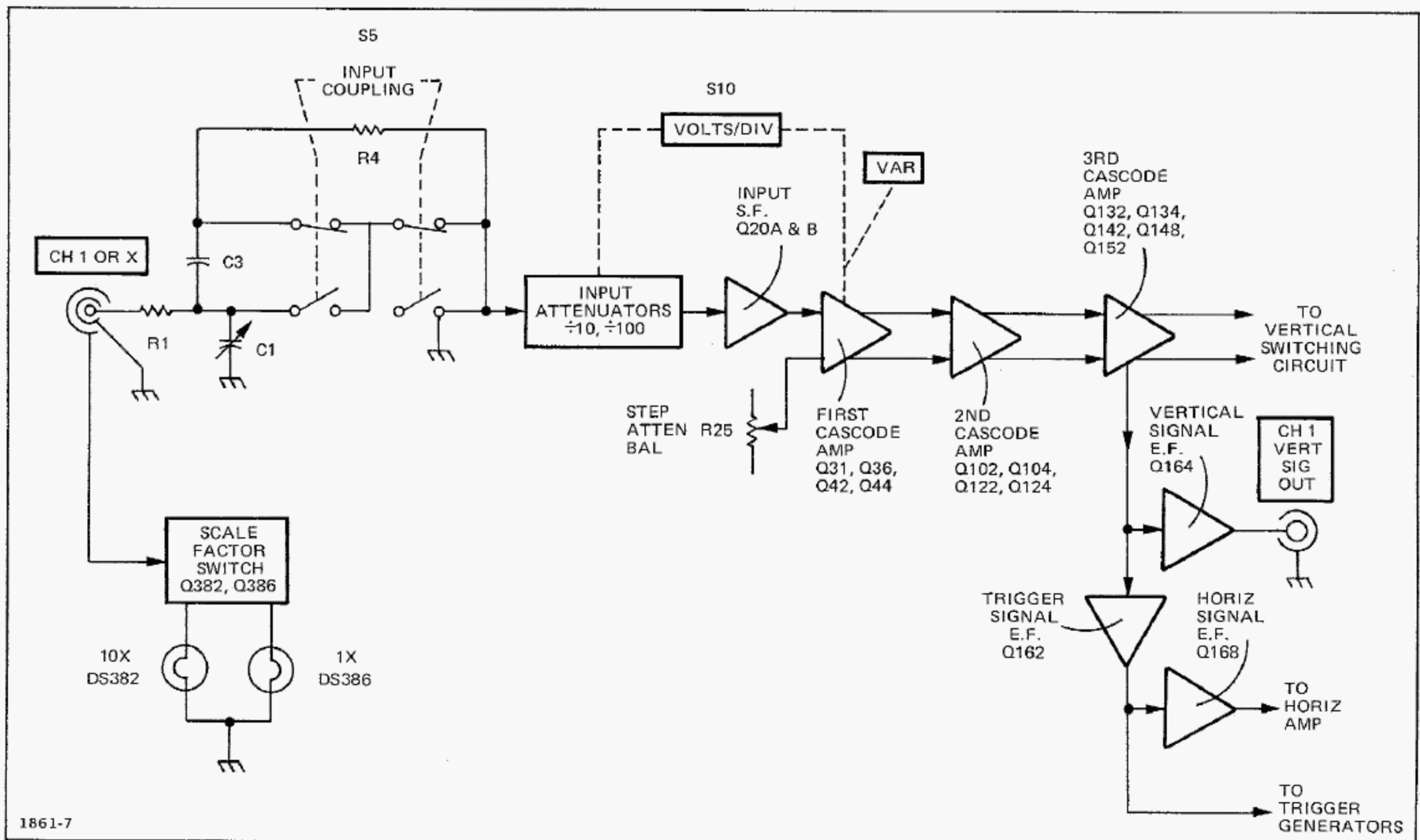

Fig. 3-2. Detailed block diagram of the Channel 1 Preamp.

Scale-Factor Switching Circuit

The vertical deflection factor for each channel is indicated by back-lighting the appropriate figures imprinted on the flange of the VOLTS/DIV knob. When a X1 probe is connected to the CH 1 OR X input connector, the base level of transistor Q386 is determined by the voltage divider composed of R384, R383 and X10 display factor bulb DS382. Transistor Q386 is biased into saturation and conducts current through the X1 indicator DS386. When Q386 conducts, the voltage level at its collector is very close to +5 volts. Therefore, there is insufficient bias at the base of Q382 to cause Q382 to conduct, and the X10 indicator DS382 remains dark. When a X10 probe with a scale factor switching connector is attached to the CH 1 OR X input connector, the base of Q382 is returned to ground through R381. This biases Q382 into saturation and conducts current through the X10 indicator light DS382. The collector level of Q382 is very near +5 volts; therefore insufficient bias exists at the base of Q386 to cause it to conduct. Since no current flows through Q386, no current flows through DS386, and the X1 indicator remains dark.

Input Coupling

Signals applied to the input connector can be ac coupled, dc coupled, or internally disconnected from the input to the Vertical Input Amplifier circuits. When the Input Coupling switch S5 is set for dc coupling, the input signal is coupled directly to the Input Attenuator stage. When ac coupled, the input signal passes through capacitor C3. This capacitor prevents the dc component of the signal from passing to the amplifier. In the GND position, S5 opens the signal path and connects the input of the amplifier to ground. This provides a ground reference without the need to disconnect the applied signal from the input connector. Resistor R4, connected across the input coupling switch, allows C3 to be pre-charged in the GND position so that the trace remains on screen when switched to the AC position.

Input Attenuator

The effective overall deflection factor of each channel of the 465 is determined by the appropriate VOLTS/DIV switch. The basic deflection factor of the Vertical Deflection System is 5 millivolts/division of crt deflection. To achieve the deflection factor values indicated on the front panel, precision attenuators are switched into the circuit and the gain of the First Cascode Amplifier stage is changed (see Table 3-1 for when gain switching and/or attenuation occur).

For the VOLTS/DIV switch positions above 20 mV, attenuators are switched into the circuit, singly or in pairs, to help produce the vertical deflection factors indicated on the front panel. These attenuators are frequency-

TABLE 3-1

VOLTS/DIV Position	Gain Switching	X10 Attenuator	X100 Attenuator
5mV			
10mV	X		
20mV	X		
50mV		X	
.1V	X	X	
.2V	X	X	
.5V			X
1V	X		X
2V	X		X
5V		X	X

compensated voltage dividers. In addition to providing constant attenuation at all frequencies within the bandwidth of the instrument, the Input Attenuators are designed to maintain the same input characteristics (1 megohm times approximately 20 picofarads) for each setting of the VOLTS/DIV switch. Each attenuator contains an adjustable series capacitor to provide correct attenuation at high frequencies and an adjustable shunt capacitor to provide correct input capacitance.

NOTE

Each attenuator is a hybrid encapsulated plug-in assembly; therefore, replacement of individual components within the attenuator is not possible. Should defects occur, the attenuator must be replaced as a unit.

A discussion of Gain Switching appears in the section titled "First Cascode Amplifier".

Source Follower

The Channel 1 signal from the Input Attenuator is connected to the Source Follower through R16 and C16. Resistor R15 provides the input resistance for this stage. Resistor R16 limits the current drive to the gate of Q20A. Diode CR18 protects the circuit by clamping the gate of Q20A at about -8.7 volts if a high amplitude negative-going signal is applied to the CH 1 OR X input connector. Q20B is a relatively constant current source for Q20A.

First Cascode Amplifier

The paraphase amplifier composed of Q32 and Q36 converts the single-ended input signal into a push-pull output signal. C33, C34 and CR34 optimize high frequency response through the amplifier stage. R37 and R38 provide thermal balance for the amplifier. C37 and C38 minimize Miller effect through Q32 and Q36. Step Attenuator Balance adjustment R25 adjusts for no baseline shift of a crt display when switching between adjacent positions of the VOLTS/DIV switch.

The frequency response of an amplifier falls off as temperature increases due to the f_t of the transistors involved. In parallel with C33, which provides adjustable high frequency peaking, is the series combination of C34-CR34. CR34 is a varicap. RT39 controls the reverse bias and hence the capacitance of CR34. The field effect diode, CR39, supplies a constant current to RT39. With a constant current through RT39 its resistance and hence the voltage across it decreases as temperature increases. This decreases the reverse bias on CR34 which increases its capacitance. The increased capacitance of CR34 adds to the capacitance of the high frequency peaking capacitor C33. This action provides temperature sensitive peaking which partially offsets the high frequency loss due to increased ambient temperature.

The Common Base Amplifier composed of Q42 and Q44 converts the input signal currents into output voltage signals across load resistors R44 and R45. Correct vertical deflection factors are obtained by using a combination of attenuation in the Input Attenuator and changing the gain of the first Cascode Amplifier. In all VOLTS/DIV switch positions that are decade multiples of 10 millivolts/division, R46 is switched in parallel with the collector load resistors R44 and R45, which reduces the load resistance and hence the stage gain by a factor of two. C47 and R47 provide adjustable high frequency compensation. In all VOLTS/DIV switch positions that are decade multiples of 20 millivolts/division, R49 is switched in parallel with the collector load resistors R44 and R45, which reduces the load resistance and hence the stage gain by a factor of four. C48 and R48 provide adjustable high frequency compensation.

Second Cascode Amplifier

Transistors Q102-Q122 and Q104-Q124 constitute the Second Cascode Amplifier of the Channel 1 vertical preamplifier. Gain adjust R118 sets the overall gain of the Channel 1 Vertical Preamplifier by adjusting the signal current into the emitters of Q122 and Q124. The VAR control R112, when rotated out of the calibrated detent position, also adjusts the signal current into Q122 and Q124 to provide uncalibrated deflection factors between

the calibrated settings of the VOLTS/DIV switch. Variable balance adjustment R120 adjusts for no baseline shift of a crt display when rotating the VAR control. Position Centering adjustment R115 centers the range of control of the Channel 1 POSITION control.

Third Cascode Amplifier

Q132 and Q134, in conjunction with Q304 and Q308 in the Vertical Switching circuit, form the Third Cascode Amplifier. Thermistor RT131 (between the emitters of Q132 and Q134) changes in value with changes in temperature. This varies the gain of the Third Cascode Amplifier to compensate for changes in total amplifier gain that occur with variations in operating temperature. The push-pull signals picked off in the emitters of Q132 and Q134 are converted to a single-ended signal by Q142 and Q148. This signal is amplified by common-base amplifier stage Q152 and applied to the bases of emitter followers Q162 and Q164. Transistor Q164 provides the output signal to the CH 1 VERT SIGNAL OUT connector located on the rear panel. The output signal at the emitter of Q162 is used as the trigger signal source in the CH 1 positions of the Trigger SOURCE switches and as the signal source for emitter follower Q168. Transistor Q168 provides the X-axis signal from the Channel 1 Preamplifier to the Horizontal Amplifier in the X-Y mode of operation. CR164, CR165, CR166 and CR167 protect the emitter circuit of Q164 in the event large voltage levels are accidentally connected to the CH 1 VERT SIGNAL OUT connector. R155 adjusts the dc level of the CH 1 trigger source signal.

CHANNEL 2 PREAMP

Introduction

The Channel 2 Preamp circuit is basically the same as the Channel 1 Preamp. Only the specific differences between the two circuits are described here. Portions of this circuit not described in the following description operate in the same manner as for the Channel 1 Preamp. Fig. 3-3 shows a detailed block diagram of the Channel 2 Preamp circuit. A schematic of this circuit is shown on diagram 2 at the rear of this manual.

Second Cascode Amplifier

The Second Cascode Amplifier in Channel 2 is basically the same as the Second Cascode Amplifier in Channel 1 except that Channel 2 INVERT switching takes place here. For normal (non-inverted) display, +5 volts is connected to the bases of transistors Q222 and Q224 by INVERT switch S225. The voltage divider comprised of R225 and R226 applies approximately +2.5 volts to the bases of

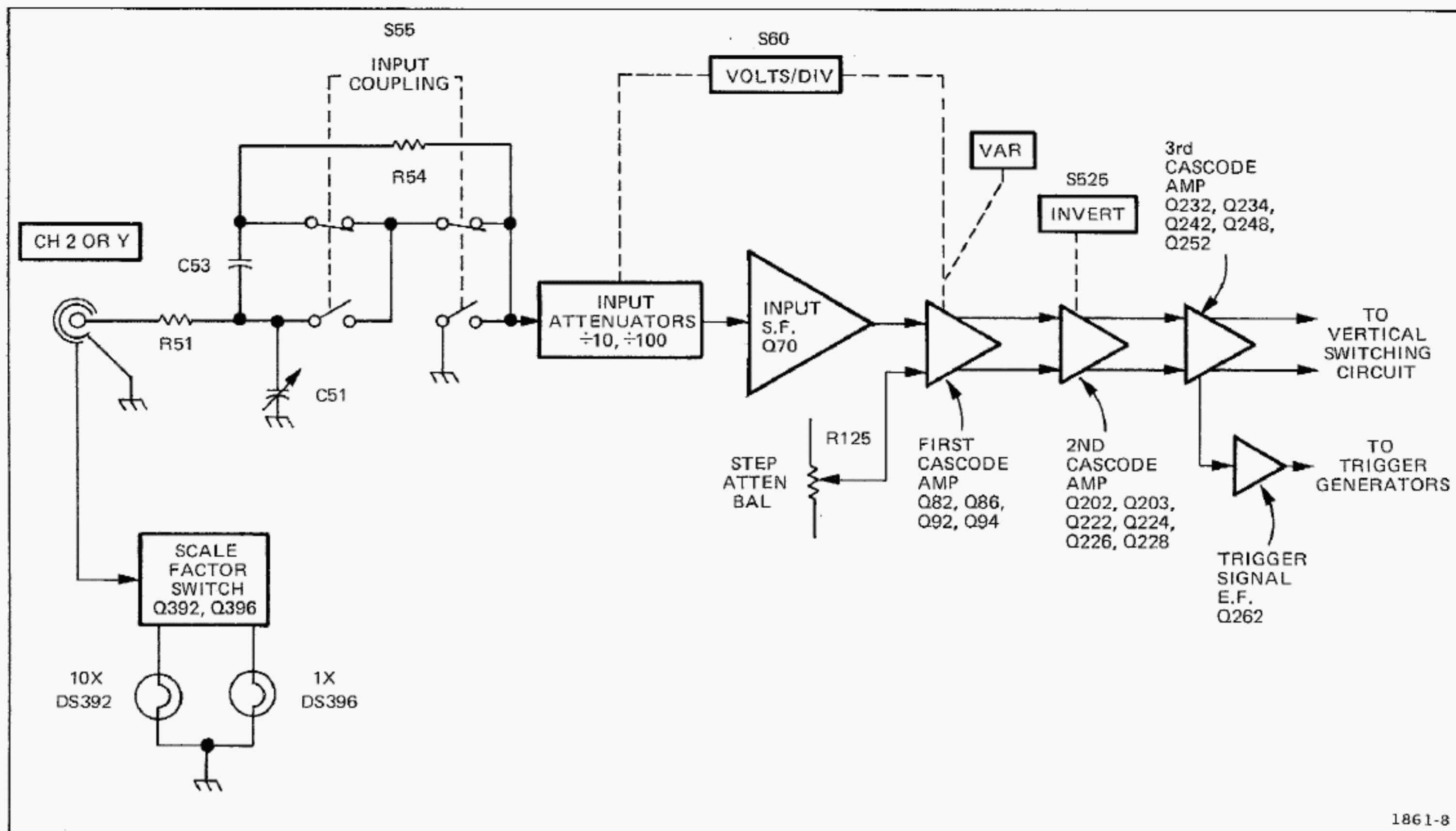

Fig. 3-3. Detailed block diagram of the Channel 2 Preamplifier.

Q226 and Q228. Transistors Q222 and Q224 are biased on, Q226 and Q228 are biased off, and the signal passes on to the output cascode amplifier stage. With the INVERT switch in the INVERT (button in) position, +5 volts is applied to the bases of Q226 and Q228. The voltage divider composed of R225 and R224 applies approximately +2.5 volts to the bases of Q222 and Q224. Transistors Q226 and Q228 are now biased on and Q222 and Q224 are biased off. The signal that was normally applied to the base of Q232 is now applied to the base of Q234 through transistor Q228 and the signal that was normally applied to the base of Q234 is now applied to the base of Q232 through transistor Q226.

Third Cascode Amplifier

The Trigger Pickoff circuit provides a signal to emitter follower Q262, which provides the trigger signal to the Trigger Generator circuits in the CH 2 positions of the SOURCE switches.

VERTICAL SWITCHING

Introduction

The Vertical Switching Circuit determines whether the Channel 1 and/or Channel 2 signals are connected to the Vertical Output Amplifier circuit. In the alternate and

chopped modes of operation both channels are alternately displayed on a shared time basis. Fig. 3-4 shows a detailed block diagram of the Vertical Switching circuit. A schematic of this circuit is shown on diagram 3 at the rear of this manual.

Diode Gates

The Diode Gates, consisting of four diodes each, act as switches that allow either of the Vertical Preamp output signals to be coupled to the Vertical Output Amplifier. CR304, CR305, CR307, and CR308 control the Channel 1 output and CR314, CR315, CR317 and CR318 control the Channel 2 output. These diodes are in turn controlled by the Switching Multivibrator for dual trace displays, or by the VERT MODE switch for single trace displays.

Channel 1 Display Only. When the CH 1 pushbutton is pressed, -8 volts is applied to the junction of CR315-CR317 in the Channel 2 Diode Gate through R367 (see the simplified diagram in Fig. 3-5). This forward biases CR315 and CR317 and reverse biases CR314 and CR318. Diodes CR314 and CR318 block the Channel 2 signal so it cannot pass to the Delay Line Driver. At the same time, in the Channel 1 Diode Gate, CR305 and CR307 are connected to +5 volts through R371. Diodes CR305 and CR307 are held reverse-biased while CR304 and CR308 are forward biased. Therefore, the Channel 1 signal passes to the Delay Line Driver.

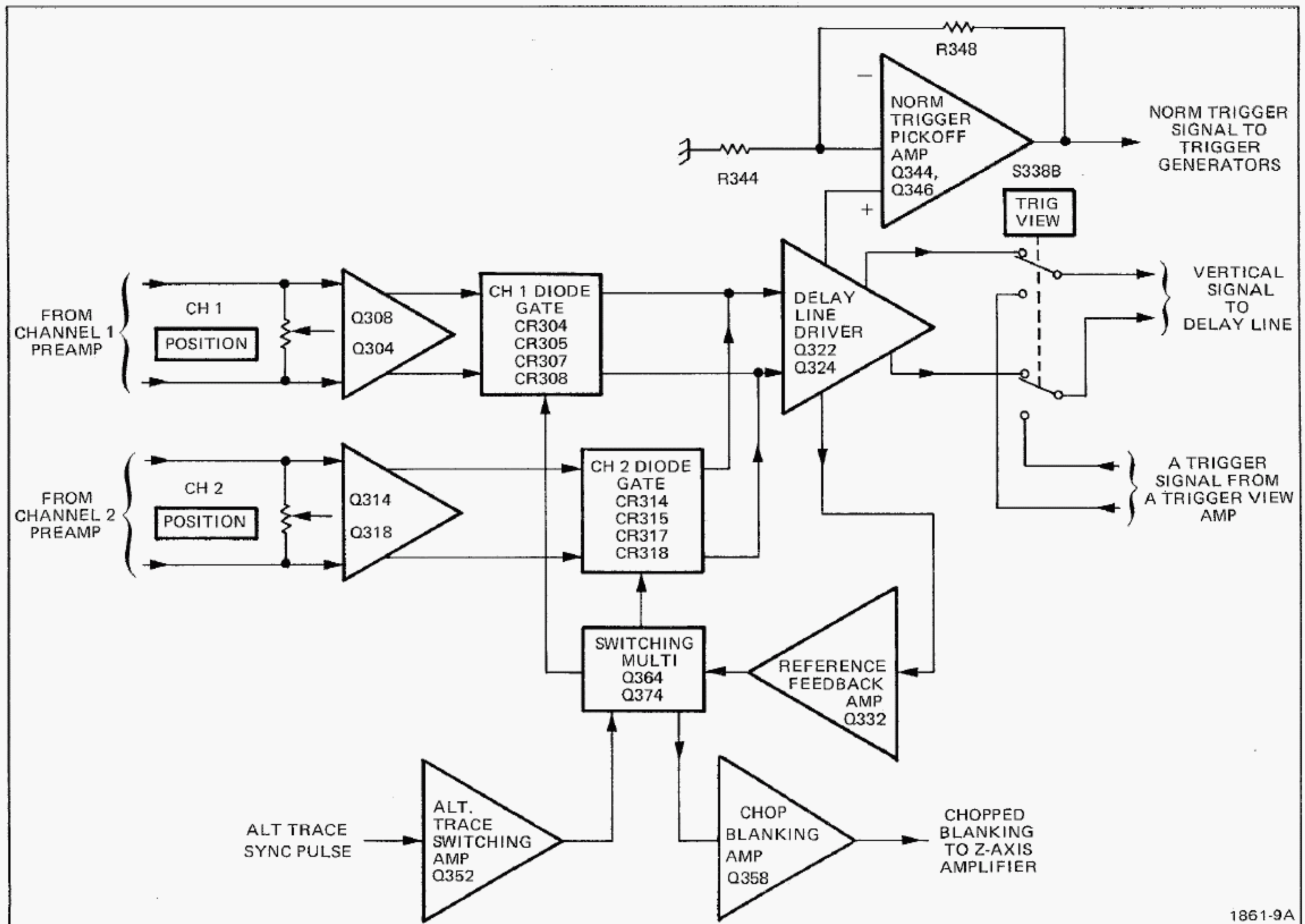

Fig. 3-4. Detailed block diagram of the Vertical Switching circuit.

Channel 2 Display Only. When the CH 2 pushbutton is pressed, the above conditions for a Channel 1 display are reversed. The junction of CR305-CR307 is connected to -8 volts through R376 and the junction of CR315-CR317 is connected to $+5$ volts through R361. The Channel 1 Diode Gate blocks the Channel 1 signal and the Channel 2 Diode Gate allows the Channel 2 signal to pass to the Delay-Line Driver.

Switching Multivibrator

Alternate Trace Display. In this mode of operation, the Switching Multivibrator operates as a bistable multivibrator. When the ALT pushbutton is pressed, -8 volts is applied to the emitter of Alternate Trace Switching Amplifier Q352 by the VERT MODE switch. Q352 is forward biased to supply current to the "on" Switching-Multivibrator transistor through R352 and CR368 or CR378. For example, if Q374 is conducting, current is supplied to Q374 through R352 and CR378. The current flow through collector resistor R371 drops the CR305-

CR307 cathode level negative so that the Channel 1 Diode Gate is blocked as for Channel 2 only operation. The signal passes through the Channel 2 Diode Gate to the Delay-Line Driver.

The alternate trace sync pulse from the A + Gate circuit is differentiated by C351 and applied to the base of Q352. At the end of A sweep the A + Gate steps negative. The resulting negative pulse momentarily turns off Q352. This turns off both Q364 and Q374. When Q352 turns on again, after the alternate trace sync pulse, the charge on C368 determines whether Q364 or Q374 conducts. For example, when Q374 was conducting, C368 was charged positive on the CR378 side to the emitter level of Q374 and negative on the CR368 side toward the negative level at the junction of CR368 and CR367. This charge is stored while Q352 is off and holds the emitter of Q364 more negative than the emitter of Q374. During the time Q364 and Q374 are turned off, the voltages at their bases become approximately equal. Now, when Q352 comes back on, the transistor with the most negative emitter conducts first,

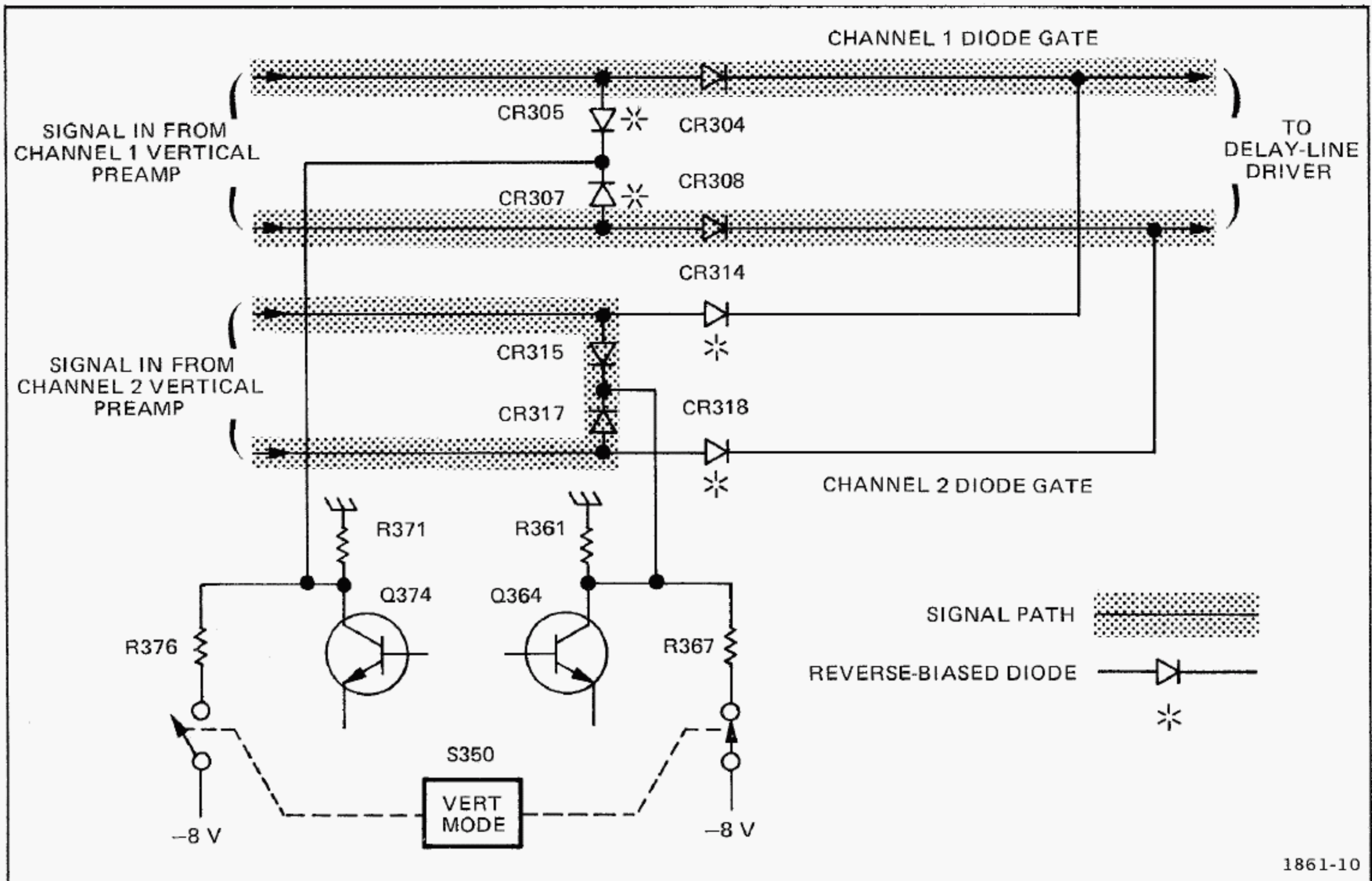

Fig. 3-5. Effect of Diode Gates on signal path (simplified Vertical Switching diagram). Conditions shown for CH 1 position of Vertical Mode switch.

and the resulting negative movement at its collector holds the other transistor off. The conditions described previously are now reversed; the Channel 2 Diode Gate is reverse-biased and the Channel 2 signal passes through the Channel 1 Diode Gate.

Chopped Mode Operation. When the CHOP pushbutton is pressed, the Switching Multivibrator free-runs at about a 250 kilohertz rate. The emitters of Q364 and Q374 are connected to -8 volts through R368, R378, and the primary of transformer T354. At the time of turn-on, one of the transistors begins to conduct; for example, Q374. The negative level at the collector of Q374 forward-biases CR305 and CR307 and back-biases CR304 and CR308 preventing the Channel 1 signal from reaching the Delay-Line Driver. Meanwhile, the Channel 2 Diode Gate passes the Channel 2 signal to the Delay-Line Driver.

The frequency-determining components in the CHOP mode are C368, R368, R370, and R378. The switching action occurs as follows: when Q374 is on, C368 attempts to charge to -8 volts through R368. The emitter

of Q364 slowly goes toward -8 volts as C368 charges. The base of Q364 is held between -8 volts and the collector level of Q374 by voltage divider R365-R374. When the emitter voltage of Q364 reaches a level slightly more negative than its base, Q364 conducts. Its collector level goes negative and pulls the base of Q374 negative through divider R364-R375 to cut Q374 off. This switches the Diode Gate to connect the opposite channel to the Delay-Line Driver. Again, C368 begins to charge towards -8 volts but this time through R378. The emitter of Q374 slowly goes negative as C368 charges until Q374 turns on. Q364 is shut off and the cycle begins again.

The Chop Blanking Amplifier Q358 provides an output pulse to the Z-Axis Amplifier circuit which blanks out the transition between the Channel 1 and the Channel 2 traces. When the Switching Multivibrator changes states, the voltage across T354 momentarily increases. A negative pulse is applied to the base of Q358 to turn it off. The width of the pulse at the base of Q358 is determined by R356 and C356. Transistor Q358 is quickly driven into cutoff and the positive going output pulse, which is coincident with trace switching, is connected to the Z-Axis Amplifier circuit through R359.

Added Mode Operation. When the ADD pushbutton is pressed, the following occurs:

1. +5 volts is applied to the cathodes of CR305 and CR307 through R371.
2. +5 volts is applied to the cathodes of CR315 and CR317 through R361.
3. -8 volts is applied to the junction of R321 and R322.

The first two actions enable both of the Channel Diode Gates so that the signal applied to the Delay-Line Driver is the algebraic sum of the Channel 1 and Channel 2 signals. The -8 volts applied to the R321 and R322 provides sufficient additional current to keep both diode gates turned on without altering the dc levels associated with the Delay-Line Driver.

Delay-Line Driver

The output from the Diode Gates is applied to the Delay-Line Driver composed of Q322 and Q324. Q322 and Q324 are connected as feedback amplifiers with R325 and R327 providing feedback from the collector to the base of their respective transistors. A sample of the signal in the collector circuit of Q322 is used for triggering in the NORM mode of trigger operation. The BW limit switch S338A connects a pi filter composed of C338, C339, L338, and L339 between the output signal lines of the Delay-Line Driver to reduce the upper -3dB bandwidth limit of the Vertical Amplifier system to approximately 20 megahertz. R335 and R336 provide reverse termination for the delay line. The TRIG VIEW switch S338B connects the output of the Trigger View Amplifier to the input of the Delay Line in place of the Delay Line Driver. This allows viewing the trigger signal present in the A Trigger Generator circuit.

Reference Feedback Amplifier

Reference Feedback Amplifier Q332 provides common mode voltage feedback from the Delay-Line Driver to allow the diode gates to be switched with a minimum amplitude switching signal. The emitter level of Q332 is connected to the junction of the Switching Multivibrator collector resistors, R371 and R361 through CR372 or CR362. The collector level of the "on" Switching Multivibrator transistor is negative and either CR362 or CR372 is forward biased. This clamps the cathode level of the forward biased shunt diodes in the applicable Diode Gate about 0.5 volt more negative than the emitter level of Q332. The level at the emitter of Q332 follows the average voltage level at the emitters of the Delay-Line Driver. The

Circuit Description—465 Service (SN B250000 & up)

shunt diodes are clamped near their switching level and therefore, can be switched very fast with a minimum amplitude switching signal. This maintains about the same current through the Diode Gate shunt diodes so they can be switched with a minimum amplitude switching signal regardless of the deflection signal at the anodes of the shunt diodes.

Normal Trigger Pickoff Amplifier

The trigger signal for NORM trigger operation is obtained from the collector of Q322. Normal Trigger DC Adjustment R340 sets the dc level of the normal trigger output signal so the sweep is triggered at the 0 level of the displayed signal when the Trigger Level control is set to 0. Q344 and Q346 are connected as a feedback amplifier with the signal applied to the non-inverting input and the feedback connected between the output and inverting input.

VERTICAL OUTPUT AMPLIFIER

Introduction

The Vertical Output Amplifier circuit provides the final amplification for the vertical deflection signal. Some instruments have a Vertical Output Amplifier using an integrated circuit (IC version). Other instruments have a Vertical Output Amplifier using individual transistors (discrete version). See Adjustment Locations 3a and 3b to identify the type of Vertical Output Amplifier board in your instrument. This circuit includes the Delay Line and part of the Beam Finder circuitry. Pushing the BEAM FINDER button compresses an overscanned display to within the viewing area. A schematic of the applicable Vertical Output Amplifier circuit is shown on diagram 4a or 4b at the rear of this manual.

Delay Line

Delay Line DL339 provides approximately 120 nanoseconds delay for the vertical signal to allow the Sweep Generator circuits time to initiate a sweep before the vertical signal reaches the deflection plates of the crt. This allows the instrument to display the leading edge of the signal originating the trigger pulse when using internal triggering.

Vertical Output Amplifier—Discrete Version

The discrete Vertical Output Amplifier is a three-stage paraphase amplifier. The first stage consists of transistors Q4402, Q4406, Q4412 and Q4416. The low-frequency compensation network, a portion of the high-frequency

Circuit Description—465 Service (SN B250000 & up)

compensation network and the Vertical Output Centering adjustment are in this stage. The next stage consists of transistors Q4432, Q4462, Q4442 and Q4472 with a high frequency temperature compensation network consisting of thermistor RT4448, resistor R4453, varicap CR4434 and capacitor C4444 plus the remaining portion of the high-frequency compensation network. The first stage consists of transistors Q4468, Q4482, Q4478 and Q4492 with a gain adjustment R4466. Capacitors C4464 and C4474 are built into the printed circuit board by lead and run capacitance. The BEAM FINDER switch, when pressed, limits the current to the emitters of transistors Q4432 and Q4442. This reduces the gain of the total stage, limiting the display to the display area of the crt.

Vertical Output Amplifier-IC Version

U440 is an integrated circuit amplifier that provides the final amplification for the vertical signal. R401 and R411 provide forward termination for the delay line. The components connected between pins 2 and 4 of U440 provide delay-line compensation. Components connected between pins 14 and 15 and pins 7 and 8 of U440 provide thermal compensation for the stage. The BEAM FINDER switch, when pressed, reduces the dynamic swing capabilities of the stage, thereby limiting the display to within the display area of the crt.

A AND B TRIGGER GENERATORS

Introduction

The Trigger Generator circuits produce trigger pulses to start the Sweep Generator circuits. These trigger pulses are derived either from the internal trigger signal from the vertical deflection system, an external signal connected to the external trigger input connectors, or a sample of the line voltage applied to the instrument. Controls are provided in each circuit to select trigger level, slope, coupling, and source. Since the A and B Trigger Generator circuits are virtually the same, only the A Trigger Generator circuit action and the differences between the A and B Trigger Generator circuits are explained. A schematic of these circuits is shown on diagram 5 at the back of this manual.

Trigger Source

The Trigger SOURCE switch S610 selects the source of the trigger signal. The sources available to the A Trigger Generator circuit are the signal(s) being displayed (NORM), Channel 1 (CH 1), Channel 2 (CH 2), LINE, and EXT. The EXT \div 10 (A Trigger Circuit only) position provides 10 times attenuation for the external trigger signal. The B Trigger SOURCE switch does not have a

LINE or an EXT \div 10 position, but has a STARTS AFTER DELAY position. In the LINE position, a sample voltage at the power line frequency is obtained from the secondary of power transformer T1501 in the Low Voltage Power Supply circuit. To prevent unwanted attenuation of the trigger signal by the low-frequency reject circuit, the Trigger COUPLING switch should not be in the LF REJ position when using line voltage as a trigger source.

Trigger Coupling

The Trigger COUPLING switches offer a means of accepting or rejecting certain components of the trigger signal. In the AC, LF REJ, and HF REJ positions, the dc component of the trigger signal is blocked by coupling capacitors C612 or C611. Frequency components below about 60 hertz are attenuated when AC or HF REJ coupled and below about 50 kilohertz when LF REJ coupled. The higher frequency components of the trigger signal are passed without attenuation. In the HF REJ position, the high frequency components of the trigger signal (above about 50 kilohertz) are attenuated, while the lower frequency components are passed without attenuation. The dc position passes all signals from dc to at least 100 MHz.

Input Source Follower

Transistor Q622 is a FET source follower. It provides a high input impedance (set primarily by R616) for the trigger signal and also provides isolation between the Trigger Generator circuit and the trigger signal source. Diode CR617 provides input protection for Q622 if excessively high-amplitude negative-going input signals are present. Q624 is a high-impedance, relatively constant, current source for Q622, and provides a measure of temperature compensation for Q622.

Paraphase Amplifier

U640 is a paraphase amplifier stage that converts the single-ended input from Source Follower Q622 into a push-pull output applied to the tunnel diode driver stage. Trigger Level Centering adjustment R635 sets the level at pins 14 and 15 of U640 so that the display is correctly triggered when the LEVEL control is centered. The LEVEL control varies the level at pins 14 and 15 of U640 to select the point on a trigger signal where triggering occurs.

The slope of the input signal that triggers the Sweep Generator circuit is determined by the setting of the SLOPE switch S630. When the SLOPE switch is set to the + position, the output signal present at pin 8 of U640 is in phase with the input signal and the output signal at pin 9 is inverted with respect to the input signal. When the SLOPE switch is set to the — position, the output signal at pin 8 is

inverted with respect to the input signal and the output signal at pin 9 is in phase with the input signal.

Tunnel Diode Driver

Q650 and Q652 are common-emitter amplifier stages that provide the signal currents necessary to switch the triggering tunnel diodes. CR650 and CR652 are 4.7 milliamp tunnel diodes. Quiescently (i.e., after the sweep holdoff period has passed, but before triggering), CR650 and CR652 are biased into their low voltage states. Q650 cannot provide sufficient current to switch CR650 to its high voltage state. Q652, however, can provide sufficient current to bias CR652 into its high voltage state; when Q652 next conducts triggering signal current, the anode of CR652 steps positive to an approximately +0.5 volt level. Since only approximately 1 milliamp of current is required to maintain CR652 in its high voltage state, this makes approximately 3 milliamp of current additionally available with which to switch CR650 to its high voltage state. Thus, the next time Q650 conducts a signal current, CR650 steps to its high voltage state, sending a positive pulse to the logic circuit to initiate sweep action. A Trigger Sensitivity adjustment R655 adjusts the tunnel diode bias to proper level that will not allow CR650 to be switched to its high voltage state until CR652 has been switched to its high voltage state. At the end of the sweep time and during holdoff, a negative level is applied to the anode of CR652,

thereby resetting both CR650 and CR652 to their low voltage states. The reset level remains during holdoff time to ensure that a sweep gating signal will not be generated until the sweep circuit has returned to its quiescent state.

A AND B SWEEP GENERATORS

Introduction

The A and B Sweep Generators produce sawtooth voltages which are amplified by the Horizontal Amplifier circuit to provide horizontal deflection on the crt. These sawtooth voltages are produced on command (trigger pulses) from the Trigger Generator circuits. The Sweep Generator circuits also produce gate waveforms that are used by the Z Axis Logic circuit to unblank the CRT during sweep time, and by the Sweep Logic circuit to terminate sweep generation. Fig. 3-6 shows a detailed block diagram of the A Sweep Generator circuit. The B Sweep Generator circuit is very similar to the A Sweep Generator; therefore only the differences in operation associated with the B Sweep Generator will be discussed. A schematic of both circuits is shown on diagram 6 at the rear of this manual.

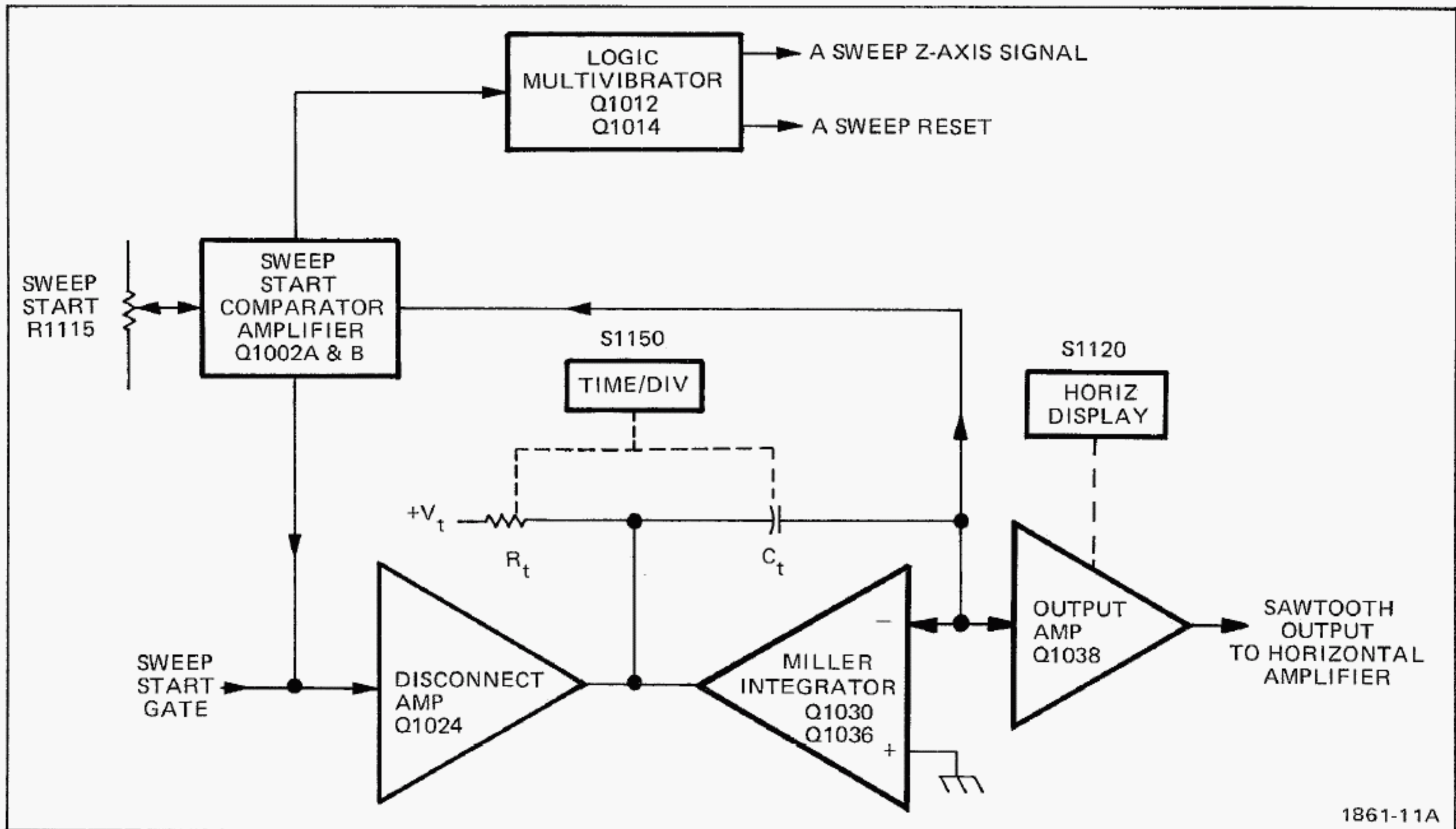

Fig. 3-6. Detailed block diagram of the A Sweep Generator.

Disconnect Amplifier

After holdoff, but before the next sweep, Disconnect Amplifier Q1024 conducts current through R1024 and the timing resistor R_t . This prevents timing current from changing the charge on C_t . The positive-going sweep start gate from Q864 turns off Q1024 and the timing circuit now begins to change the charge on C_t .

Sawtooth Generator

Q1030 and Q1036 compose a Miller Integrator circuit. When Q1024 turns off, C_t begins to charge through R_t . This causes the junction of C_t and R_t , the gate of Q1030, to begin to go more positive. As the gate of Q1030 goes more positive, the source of Q1030 also starts to go more positive. This biases Q1036 on harder, and its collector moves in the negative direction (less positive). This couples back through C_t and opposes the positive change at the gate of Q1030. The gate of Q1030 only changes about 10 millivolts. Although C_t tries to charge toward $+V_t$, the action of the gate of Q1030 being held virtually constant and the collector of Q1036 going more negative results in the reduction of the charge on C_t (it discharges). Since the voltage at the gate of Q1030 remains constant, the voltage across R_t remains constant. Since the voltage across R_t remains constant, the current through R_t (the current being discharged from C_t) also remains constant. The constant current being discharged from C_t results in a linear ramp across it. The resultant output signal at the collector of Q1036 appears as a negative going ramp from +13 volts to +2 volts.

When the ramp reaches +2 volts, Q1012 sends a pulse (see logic multivibrator) to U870 to initiate retrace. Q1024 turns on and its collector goes more negative. This moves the gate of Q1030 in the negative direction, which causes the voltage on the base of Q1036 to go more negative, causing its collector to go more positive. C_t now quickly charges to its quiescent state through Q1024.

Output Buffer Amplifier

The Output Buffer Amplifier is a common-base amplifier with the signal current-driven into the emitter. It provides the output sawtooth current signal to the Horizontal Amplifier and provides a measure of isolation between the Sawtooth Generator and the Horizontal Amplifier. The HORIZ DISPLAY switch connects to this stage to control the A sawtooth output in the various horizontal modes of operation. In the A and A INTEN modes of operation, the A sweep signal passes through Q1038 to the Horizontal Amplifier. However, in the MIX and B DLY'D modes, -8 volts is connected to zener diode VR1039 which sets the emitter of Q1038 to about -1.8 volts. This biases Q1038 off, preventing the A sawtooth signal from passing to the Horizontal Amplifier.

Sweep Start Amplifier

Just before the sweep starts to run down, the levels at the bases of Q1002 A and B are approximately equal. When the sweep starts to run down, the base of Q1002B goes negative, which increases the forward bias on CR1004. This in turn decreases the forward bias on CR1001, which, very shortly after the start of the sweep, becomes reverse biased to interrupt the current through Q1002A. The circuit remains in this condition until after the sweep retrace is complete. When the circuit returns to quiescence, Q1002A again begins to conduct through R1024. This sets the current through Q1024, which establishes the starting point for the sweep. The Sweep Start adjustment sets the base level of Q1002A. This level is also connected to the base of Q1062A in the B Sweep Generator except in the MIX mode of operation. This ensures that B sweep starts at the same level as A Sweep.

Logic Multivibrator

Q1012 and Q1014 compose a multivibrator. At quiescence, Q1014 is conducting and Q1012 is turned off. When the sweep starts to run, the negative-going ramp at the collector of Q1036 is coupled through the base of Q1002B and CR1004 to the cathode of CR1011. When the collector of Q1036 reaches about +2 volts the cathode of CR1011 reaches about 4 volts. CR1011 begins conducting and turns on Q1012 which then turns off Q1014. The resulting positive step at the collector of Q1012 is connected to pin 16 on U870 which initiates retrace and holdoff. The negative-going pulse at the collector of Q1014 is applied to the A Sweep Z-Axis Logic Gate to blank the crt as soon as a sweep-end command is generated.

B Sweep Generator Differences

There are three main differences between the A and B Sweep Generators. The B Sweep Output Buffer Amplifier is prevented from passing the B Sweep signal to the Horizontal Amplifier in the A and A INTEN positions of the HORIZ DISPLAY switch. There is a transistor stage connected as a constant current source in the emitter circuit of Q1062A and B (needed during MIX mode operation). The Sweep Start Level connected to the base of Q1062A is not always a fixed dc level. During MIX mode operation the A Sweep sawtooth signal is applied to the base of the Q1062A. Now, the dc level at which the B Sweep Generator will start generating its sawtooth waveform is constantly being changed by the A Sweep sawtooth. The output waveform from the B Sweep Generator takes the form of a composite sawtooth waveform, with the first and last parts occurring at a rate determined by the A Sweep Generator and the middle part occurring at a rate determined by the B Sweep Generator.

SWEEP AND Z AXIS LOGIC CIRCUIT

Introduction

The Sweep and Z-Axis Logic circuit derives the logic levels necessary to control the sequence of events associated with sweep generation and crt unblanking. The A+ and B+ gate signals are also generated in this circuit. Positive logic terminologies and symbologies will be used in the following explanation of circuit operation. A schematic of this circuit is shown on diagram 8 at the rear of this manual. See the waveforms adjacent to diagram 8 for logic levels and their time relationship to A sweep operation.

A Sweep Gate

Q862 and Q864 compose the A Sweep Gate circuit. They form an emitter coupled stage where only one transistor can be conducting at any time. The input signal to the stage is the positive-going trigger signal from the A Trigger Fire tunnel diode in the A Trigger Generator circuit. The signal at the collector of Q862 is connected to the A Z-Axis Gate circuit to control crt blanking and to generate the A+ gate signal. The signal at the collector of Q864 is connected to the emitter of the Sweep Disconnect Amplifier (Q1024) in the A Sweep Generator circuit to initiate A Sweep generation.

B Sweep Gate

Q812 and Q814 compose the B Sweep Gate circuit. They also form an emitter-coupled stage where only one transistor can be conducting at any time. The input signal to the stage is the positive-going trigger signal from the B Trigger Fire tunnel diode in the B Trigger Generator circuit. The signal at the collector of Q812 is connected to the B Z-Axis Gate circuit to control crt blanking and to generate the B+ gate signal. The signal at the collector of Q814 is connected to the emitter of the Sweep Disconnect Amplifier (Q1084) in the B Sweep Generator circuit to initiate B Sweep generation.

Sweep Control Integrated Circuit

U870 is the Sweep Control integrated circuit. Several functions are performed in this stage, depending on the mode of operation of the instrument sweep generators. The following is a brief explanation of the function associated with each pin of the IC.

Pin 1. This is the positive Auto Sense input. The signal connected here comes from the A Trigger Fire tunnel diode.

Pin 2. This is a reference input to the Auto Sense circuit. A fixed dc level established by R871 and R872 is connected here.

Pin 3. This is the + auto gate terminal. In the AUTO mode of operation, if no trigger signals are applied to pin 1 of U870 during the approximately 100 milliseconds following the end of holdoff the gate level at pin 3 steps LO to turn Q864 on which initiates a sweep.

Pin 4. Not used in this application.

Pin 5. Input terminal for negative voltage supply.

Pin 6. This is the auto gate timing terminal. R879 and C879 determine the amount of time between the end of holdoff and the generation of the auto gate.

Pin 7. The output of this terminal lights the TRIG'D light when a triggered gate has occurred.

Pin 8. This is the holdoff timing terminal. The RC network connected to this terminal (selected by the TIME/DIV switch) determines the length of holdoff time.

Pin 9. Ground terminal.

Pin 10. This is the Holdoff output terminal. The gate level present here is LO during sweep holdoff time and HI otherwise.

Pin 11. The output of this terminal lights the READY light when operating in the single sweep mode.

Pin 12. This is the single sweep mode terminal. When +5 volts is applied to this terminal the sweep operates in the single sweep mode; when the terminal is left open or grounded the sweep operates in the repetitive mode.

Pin 13. Not used in this application.

Circuit Description—465 Service (SN B250000 & up)

Pins 14 & 15. Single sweep reset terminals. Pushing the SINGL SWP button prepares the single sweep circuitry to respond to the next one triggering event. Also causes the READY light to come on.

Pin 16. This is the holdoff start input terminal. The HI sweep reset gate pulse from the sweep generators is applied here to initiate sweep holdoff.

Pin 17. This is the sweep disable output terminal. The gate level at this terminal is HI during holdoff and LO otherwise.

Pin 18. Sweep lockout input. +5 volts applied to this terminal disables all sweep action.

Pin 19. Auto mode terminal. Grounding this terminal enables auto sweep operation.

Pin 20. Input terminal for positive voltage supply.

Holdoff Timing

A resistor and capacitor network connects to pin 8 of U870. Various resistor and capacitor combinations switch into the circuit depending on the setting of the A TIME/DIV switch. At sweep end, pin 8 of U870 is released and C_{ho} starts charging. When the charge on C_{ho} causes pin 8 to reach about +4 volts, pin 17 goes HI and pin 8 steps back to LO. R1155 allows lengthening the time constant which increases holdoff time.

A Sweep Holdoff Amplifier

Q854 is the A Sweep Holdoff Amplifier. The holdoff gate waveform is applied to the base of Q854 through R858 and C858 from pin 17 of U870. When Q854 is turned off (during holdoff time), its collector is LO and CR851 is forward biased, which resets both the Arm and Fire Trigger tunnel diodes in the A Trigger Generator. When Q854 is turned on (any time other than holdoff time), its collector level is HI and CR851 is reversed biased. This allows the trigger tunnel diodes in the A Trigger Generator to respond to the next adequate triggering signal.

B Sweep Holdoff Amplifier

Q804 is the B Sweep Holdoff Amplifier. Its circuit action is identical to that described for the A Sweep Holdoff

Amplifier except that there are three gate signal sources that control the state of the stage. The three sources are the holdoff gate from pin 17 of U870 (through CR859), the collector of Q1052 in the Delay Pickoff Comparator, and the collector of Q822 in the B Latch Multivibrator (through CR809). All three gate sources must be in their LO state for B Sweep to be triggerable; any one of the sources in its HI state will disable the B Trigger Generator tunnel diodes.

B Sweep Latch

Q822 and Q828 compose the B Sweep Latch. Quiescently, (before either the A or B Sweeps have reached their maximum amplitudes) both transistors are off. Then, the sweep reset pulse from whichever sweep terminates first will be applied to the base of Q828 (A Sweep reset through CR826; B Sweep reset through CR825). The positive-going reset pulse turns on Q828 and the negative-going movement at its collector turns on Q822. The collector of Q822 in turn pulls up on the base of Q828, holding Q828 on, which causes the circuit to stay in its on or latched state. The HI at the collector of Q822 is applied to the base of the B Sweep Holdoff Amplifier (through CR809) to disable the B Trigger tunnel diodes. In the B ENDS A position of the A TRIG HOLDOFF control the HI is also applied to the holdoff start input terminal of the Sweep Control integrated circuit through C286. Thus, when B Sweep ends A Sweep ends also.

The B Latch Multivibrator is reset to its quiescent state by the LO Holdoff level present at pin 10 of the Sweep Control integrated circuit during A Sweep holdoff.

A Sweep Z-Axis Gate

Q1304 and Q1306 comprise the A Sweep Z-Axis Gate. They form an emitter-coupled stage where only one transistor can be conducting at any time. The controlling signal inputs come from the collector of Q862 in the A Sweep Gate, the blanking signal from Q1014 in the A Sweep Generator, and Q824 in the B Latch Multivibrator (only in the MIX mode of operation). The blanking signal for use in the Z-Axis Amplifier is taken from the collector of Q1306 (through CR1342). The collector signal of Q1304 is applied to the A+ gate Emitter Follower.

In all positions of the HORIZ DISPLAY switch except for B DLY'D, -8 volts is connected to the anode of CR1306. This reverse biases CR1306, which allows the gate signal at the collector of Q1306 to pass through CR1342. In the B DLY'D position of the HORIZ DISPLAY switch, -8 volts is no longer connected to CR1306. This allows CR1306 to be forward biased, which pulls up on the cathode of CR1342. This reverse-biases CR1342, which blocks the A blanking signal from reaching the Z-Axis Amplifier.

In all positions of the HORIZ DISPLAY switch except MIX, —8 volts is connected to the cathode of CR832. This keeps CR831 reverse biased and prevents the collector signal of Q824 from affecting the A Z-Axis Gate. However, in the MIX position of the HORIZ DISPLAY switch, —8 volts is no longer connected to CR832. Now, when the B Sweep ends and sets the B Sweep Latch circuit, the collector signal of Q824 (through CR831) switches the A Sweep Z-Axis Gate causing the crt display to be completely blanked. This prevents any further display of A Sweep in the MIX mode even though A Sweep may still be running.

B Sweep Z-Axis Gate

Q1324 and Q1326 compose the B Sweep Z-Axis Gate. They form an emitter-coupled stage where normally one transistor is on and the other is off. The controlling signal inputs come from the collector of Q812 in the B Sweep Gate and the blanking signal from Q1074 in the B Sweep Generator. The blanking signal for use in the Z-Axis Amplifier is taken from the collector of Q1326 (through CR1344). The collector signal of Q1324 is applied to the B+ Gate Emitter follower.

In the A position of the HORIZ DISPLAY switch, —8 volts is applied to the cathode of CR1347, which causes CR1345 to be back biased. The collector of Q1326 is pulled positive through R1326 and CR1326, which in turn back biases CR1344, preventing the B Sweep Z-Axis Gate from affecting crt unblanking. In the MIX and A INTEN positions of the HORIZ DISPLAY switch, —8 volts is removed from the cathode of CR1347 and applied to the anode of CR1326. This forward biases CR1345 and reverse biases CR1326. Diode CR1344 is still reverse biased, but when B Sweep starts, the collector of Q1326 steps negative enough to forward bias CR1344 and add a slight amount of unblanking to the A Sweep unblanking already present. This provides a measure of intensification for the B Sweep portion of an A INTEN or MIX display. In the B DLY'D position of the HORIZ DISPLAY switch, —8 volts is applied to the cathode of CR1347 and the anode of CR1326. This reverse biases both CR1345 and CR1326, which allows the full B Sweep unblanking signal to pass through CR1344. The A Sweep Z-Axis Gate output diode CR1342 is held reverse biased and the only unblanking signal present at the input to the X-Axis Amplifier will be the B Sweep signal.

A+ Gate and B+ Gate Emitter Followers

Q1314 and Q1334 are emitter followers providing the A+ GATE and the B+ GATE output signals available at the instrument rear panel. The output signals are positive-going rectangular waveforms, approximately 5.5 volts in amplitude. The amplitude is set in the collectors of Q1304 and Q1324. For example, when Q1304 is conducting the

base of Q1314 can go no more negative than approximately —0.7 volt (limited by CR1304). When Q1304 is not conducting, the base of Q1314 rises to the decoupled +5 volts power supply level through R1304. Diodes CR1315, CR1316, CR1335, and CR1366 provide protection against accidental application of damaging voltage levels to the A+ GATE and B+ GATE output connectors.

HORIZONTAL AMPLIFIER

Introduction

The Horizontal Amplifier circuit provides the output signals to the crt horizontal deflection plates. The signal applied to the input of the Horizontal Amplifier is determined by the TIME/DIV switch and the HORIZ DISPLAY switch. The signal can come from either the sweep generators within the instrument or some external signal applied to the CH 1 OR X input connector (X-Y mode of operation). The Horizontal Amplifier also contains the X10 magnifier, horizontal positioning, and some beam finder circuitry. Fig. 3-7 shows a detailed block diagram of the Horizontal Amplifier circuit. A schematic of this circuit is shown on diagram 9 at the rear of this manual.

X-Axis Amplifier

In all positions of the TIME/DIV switches except X-Y, the input signal to the base of Q1224 will be sawtooth waveforms from the sweep generators. In the X-Y mode however, the sweeps are disabled and the signal applied to Q1224 comes from the Channel 1 Preamp via the X-Axis Amplifier. This stage includes Q1214, Q1218 and their associated circuitry.

Q1214 is connected as a feedback amplifier with R1214 as the feedback element. The input resistance is made up of R1211 and the gain-setting adjustment of R1215. When not operating in the X-Y mode, the base of Q1214 rises toward the +15 volt supply but is clamped at approximately +5.7 volts by CR1218 and R1218. This reverse biases the base-emitter junction of Q1214. The base of Q1218 also rises to approximately +5.7 volts. With the junction of R1202-R1219 at approximately 0 volt, Q1218 is also biased off.

When the TIME/DIV switches are set to the X-Y position (fully counterclockwise), —8 volts is applied to the junction of R1212 and R1217. Also, +5 volts is applied to the emitter circuit of Q1218 through CR1202. This biases the Z-Axis Amplifier circuit into conduction. At the same time, +5 volts is applied to the Channel 1 Scale-Factor

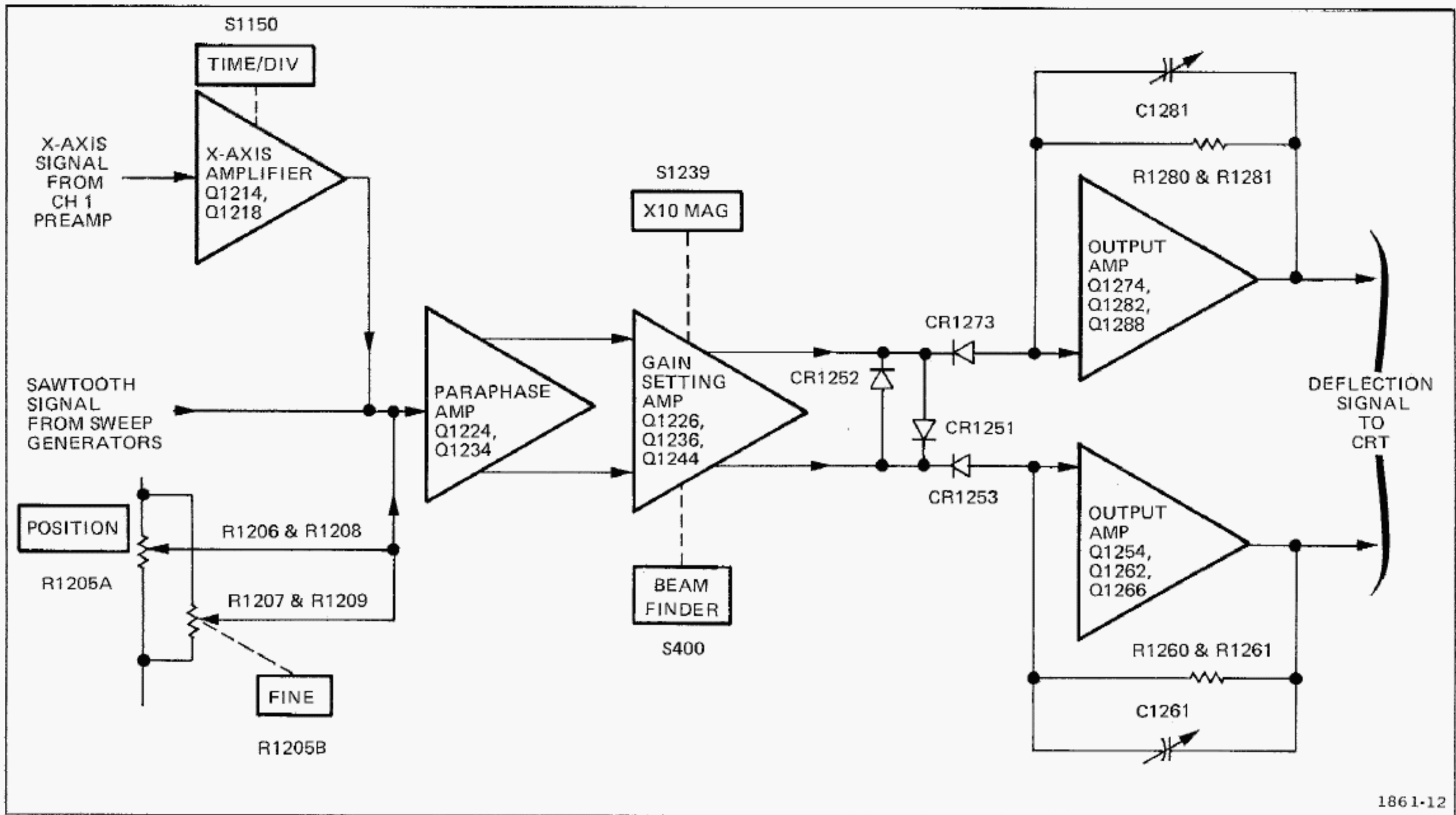

Fig. 3-7. Detailed block diagram of the Horizontal Amplifier.

Switching Amplifier circuit (through CR1201) and to pin 18 of the Sweep Control integrated circuit U870. This enables both scale-factor indicating circuits at the same time and disables sweep generation.

Input Paraphase Amplifier

Q1224 and Q1234 compose the Input Paraphase Amplifier. This is an emitter-coupled amplifier stage that converts the single-ended input signal to a push-pull output signal. The signal at the collector of Q1224 is opposite in phase to the input signal. The signal at the collector of Q1234 is in phase with the input signal. Thermistor RT1230 reduces in value with increases in ambient temperature to increase the gain of the stage. This compensates for slight changes in amplifier gain that occur as operating temperatures vary. R1205A and R1205B are the Horizontal POSITION and FINE controls, respectively. The FINE control has approximately one tenth the range of the POSITION control and provides fine adjustment of a magnified display.

Gain Setting Amplifier

Q1226 and Q1236 are an emitter coupled push-pull amplifier stage. Q1244 is a constant current supply for the stage. The gain of the Horizontal Amplifier is controlled by adjusting the resistance connected between the emitters

of this stage. The X1 Gain adjustment R1237 adjusts unmagnified horizontal gain and the X10 Gain adjustment R1238 adjusts magnified horizontal gain. Magnifier Registration adjustment R1225 balances quiescent dc current in Q1226 and Q1236 so that a center screen display does not change position when the X10 magnifier is turned on.

When the BEAM FINDER pushbutton is pressed, R1249 is connected to ground. This reduces the current supplied through Q1244, which has the effect of shifting the operating level at the collector of Q1244 in the positive direction. This causes the point at which the Horizontal Amplifier limits to decrease, thereby ensuring that an overscanned display will remain within the viewing area of the crt.

Output Amplifier

The push-pull signal from the Gain Setting Amplifier is connected to the Output Amplifier through CR1253 and CR1273. Each half of the Output Amplifier can be considered as a single-ended feedback amplifier, which amplifies the signal current at the input to produce a voltage output to drive the horizontal deflection plates of the crt. The amplifiers have a low input impedance and require very little voltage change at the input to produce the desired output voltage change. The Output Amplifiers

are limited from overdrive by CR1251, CR1252, CR1253, and CR1273. The input diodes CR1253 and CR1273 become back-biased when the signal level at either input becomes too positive, and the diodes connected back to back between the two signal paths ensure that the signal amplitude side to side will be limited to a maximum of about 0.7 volt.

Transistors Q1254 and Q1274 are inverting amplifier stages whose collector signals drive the emitters of complementary amplifiers Q1262-Q1266 and Q1282-Q1286 respectively. C1256, C1262, and C1282 provide a signal path for fast ac signal current from one side of the amplifier to the other. R1260-R1261 and R1280-R1281 are the feedback elements in the amplifier with C1261 and C1281 providing high-frequency compensation. The output signal from Q1262-Q1266 drives the right crt deflection plate, while the signal from Q1282-Q1286 drives the left.

(crt). Fig. 3-8 shows a detailed block diagram of the CRT circuit. A schematic of this circuit is shown on diagram 10 at the rear of this manual.

High-Voltage Oscillator

Q1418 and associated circuitry compose the high-voltage oscillator that produces the drive for high-voltage transformer T1420. When the instrument is turned on, current through Q1416 provides forward bias for Q1418. Transistor Q1418 conducts and its collector current increases, which develops a voltage across the collector winding of T1420. This produces a corresponding voltage increase in the feedback winding of T1420, which is connected to the base of Q1418, and Q1418 conducts even harder. Eventually the rate of collector current increase in Q1418 becomes less than that required to maintain the voltage across the collector winding, and the output voltage drops. This turns off Q1418 by way of the feedback voltage to the base. The voltage waveform at the collector of Q1418 is a sine wave of the resonant frequency of T1420. Q1418 remains off while the field collapses in the primary of T1420. When the field is collapsed sufficiently, the base of Q1418 becomes forward biased into conduction again and the cycle begins anew. The amplitude of

CRT CIRCUIT

Introduction

The CRT circuit provides the voltage levels and control circuits necessary for operation of the cathode-ray tube

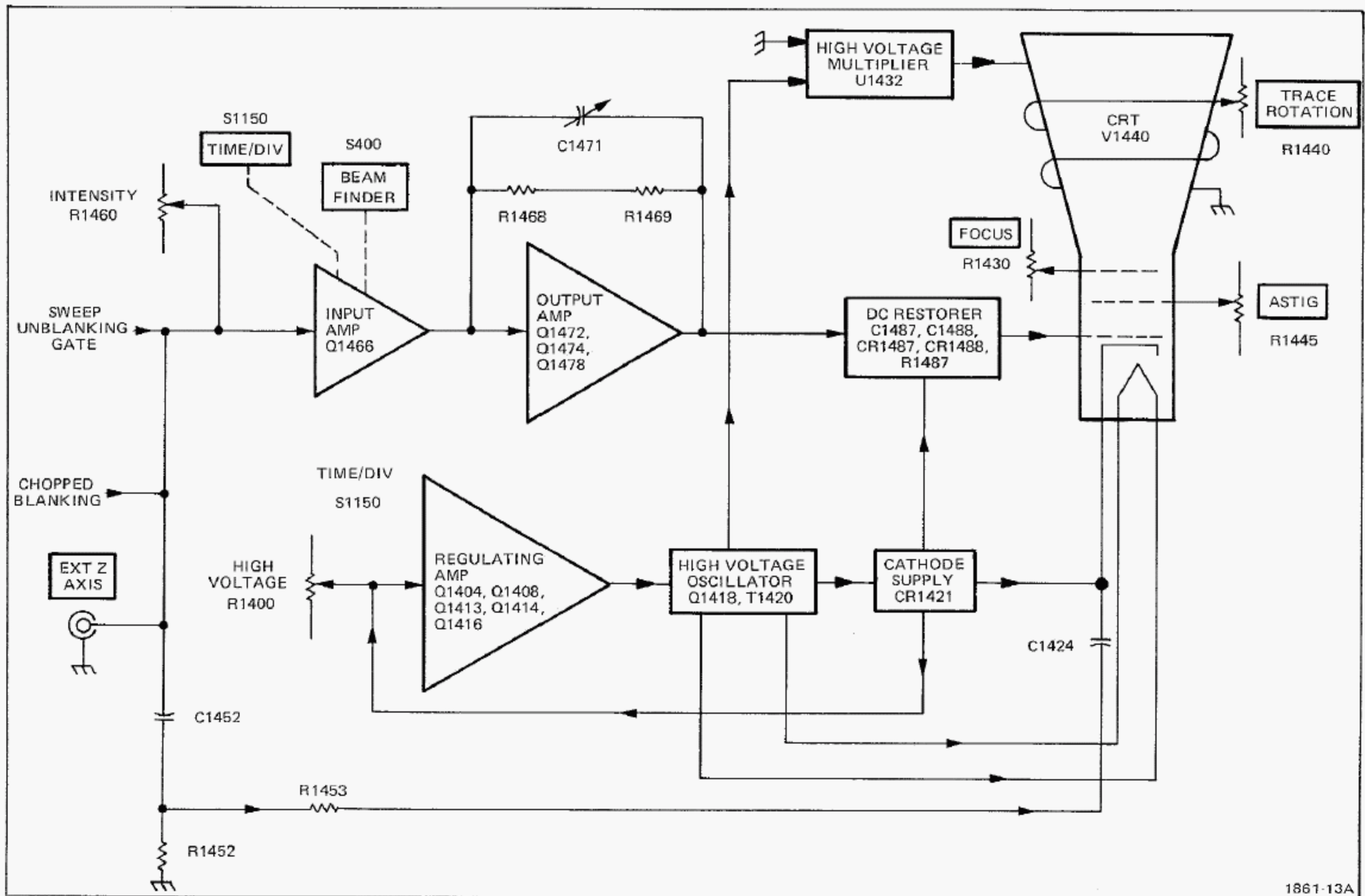

Fig. 3-8. Detailed block diagram of the CRT and Z-Axis circuits.

Circuit Description—465 Service (SN B250000 & up)

substantiated oscillation depends upon the average current delivered to the base of Q1418. The frequency of oscillation is approximately 50 kilohertz. Fuse F1419 protects the unregulated +15 volt supply in the event the High-Voltage Oscillator stage becomes shorted. C1419 and L1419 decouple the unregulated +15 volt supply and prevent the current changes present in the circuit from affecting the +15 volt regulator.

High-Voltage Regulator

Feedback from the crt cathode —2450 volt supply is applied to the base of Q1404 through R1431D. Any change in the level at the base of Q1404 produces an error signal at the collector of Q1404, which is amplified by Q1408 and Q1416 and applied to the base of Q1418 through the feedback winding of T1420.

Regulation occurs as follows. If the output voltage at the —2450 volt test point starts to go positive (less negative), this positive-going change is applied to the base of Q1404. Q1404 conducts harder, which in turn causes Q1408 and Q1416 to conduct harder. This results in greater bias current to the base of Q1418 through the feedback winding of T1420. Now, Q1418 is biased closer to its conduction level so that it comes into conduction sooner to produce a larger induced voltage in the secondary of T1420. This increased voltage appears as a more negative voltage at the —2450 volt test point to correct the original positive-going change. By sampling the output from the crt cathode supply in this manner, the total output of the High-Voltage Supply is held relatively constant.

The output voltage level of the High-Voltage Supply is controlled by the High Voltage Adjustment R1400 in the base circuit of Q1404. This adjustment sets the conduction of Q1404 to a level that establishes a —2450 volt operating potential at the crt cathode.

Q1413 and Q1414 compose an overvoltage protection circuit. If the crt cathode supply approaches approximately —3000 volts, the voltage level at the emitter of Q1416 will be very close to —6 volts. Normally Q1413 and Q1414 are biased off and do not conduct. When the voltage level at the emitter of Q1416 reaches approximately —6 volts, Q1413 is biased into conduction which in turn biases Q1414 on. Q1414 now starts to turn off Q1416. This reduces the base drive to Q1418 and prevents the amplitude of oscillations from increasing. This prevents the crt cathode supply from going more negative than approximately —3000 volts.

High-Voltage Rectifiers and Output

The high-voltage transformer T1420 has two output windings. One winding provides heater voltage for the cathode-ray tube. The heater voltage can be supplied from the High-Voltage Supply, since the cathode-ray tube has a very low heater current drain. The cathode and heater of the crt are connected together to elevate the heater and prevent cathode-to-heater breakdown. One high-voltage winding provides both the negative cathode potential and the positive anode accelerating voltage. The crt grid bias voltage is derived by a dc restorer circuit that uses a sample of the signal in the high-voltage winding in conjunction with dc levels supplied by the Z-Axis Amplifier and the negative cathode potential.

The positive accelerating potential is supplied by High Voltage Multiplier, U1432. Regulated output voltage is approximately +15,500 volts. The negative cathode potential is supplied by half-wave rectifier CR1241. Voltage output is —2450 volts. Voltage variations in this supply are monitored by the High-Voltage Regulator circuit to provide a regulated high-voltage output.

CRT Control Circuits

Focus of the crt display is controlled by FOCUS control R1430. ASTIG adjustment R1445, which is used in conjunction with the FOCUS control to provide a well-defined display, varies the positive level on the astigmatism grid. Geometry adjustment R1442 varies the positive level on the horizontal deflection plate shields to control the overall geometry of the display.

Two adjustments control the trace alignment by varying the magnetic field around the crt. Y-Axis adjustment R1446 controls the current through L1446, which affects the crt beam after vertical deflection, but before horizontal deflection. Therefore, it affects only the vertical (Y) components of the display. TRACE ROTATION adjustment R1440 controls the current through L1440 and affects both vertical and horizontal rotation of the beam.

Z-Axis Amplifier

The Z-Axis Amplifier circuit controls the crt intensity level from several inputs. The effect of these input signals is to either increase or decrease the trace intensity, or to completely blank portions of the display. The input transistor Q1466 is a current-driven, low input impedance amplifier. It provides termination for the input signals as well as isolation between the input signals and the following stages. The current signals from the various

control sources as connected to the emitter of Q1466 and the algebraic sum of the signals determines the collector conduction level.

Q1472, Q1474, and Q1478 compose a feedback amplifier stage; R1468 and R1469 are the feedback elements. C1469 and C1471 provide high frequency compensation. Q1472 is an emitter follower providing drive to complementary amplifier Q1474-Q1478. Diodes CR1468, CR1472, and CR1476 provide protection in the event of high-voltage arcing.

In the .1 s, .2 s, .5 s, and X-Y positions of the TIME/DIV switch, +5 volts is connected to the anode of CR1463. This limits the effective range of the INTENSITY control to reduce the unblanking capabilities of the amplifier, thereby reducing the possibility of inadvertently burning the crt phosphor.

When the BEAM FINDER pushbutton is pressed, two things occur: First, +15 volts is applied to the anode of CR1465 which lifts the emitter of Q1466 sufficiently positive to ensure there will be no conduction through Q1466. Secondly, R1470 becomes connected to -8 volts through R1477 which establishes a fixed predetermined unblanking level at the output of the amplifier. Thus, the INTENSITY control and all of the input unblanking signals have no control over the intensity level of the crt display when the BEAM FINDER pushbutton is pressed.

DC Restorer Circuit

C1488, C1487, CR1483, CR1487, CR1488, and R1486 form a dc restorer circuit. All dc levels in this circuit are referenced to the negative potential of the crt cathode. The voltage difference across R1486 approximately equals the voltage swing present at the junction of CR1482 and CR1483. The control grid end of R1486 is more negative than the end connected to CR1488. The amplitude of the voltage swings present at the junction of CR1482 and CR1483 is determined by the voltage levels established by the Z-Axis Amplifier and the CRT Bias adjust circuit.

CALIBRATOR

Introduction

The Calibrator circuit produces a square-wave output signal with accurate voltage and current amplitudes. This output is available as a voltage or current at the

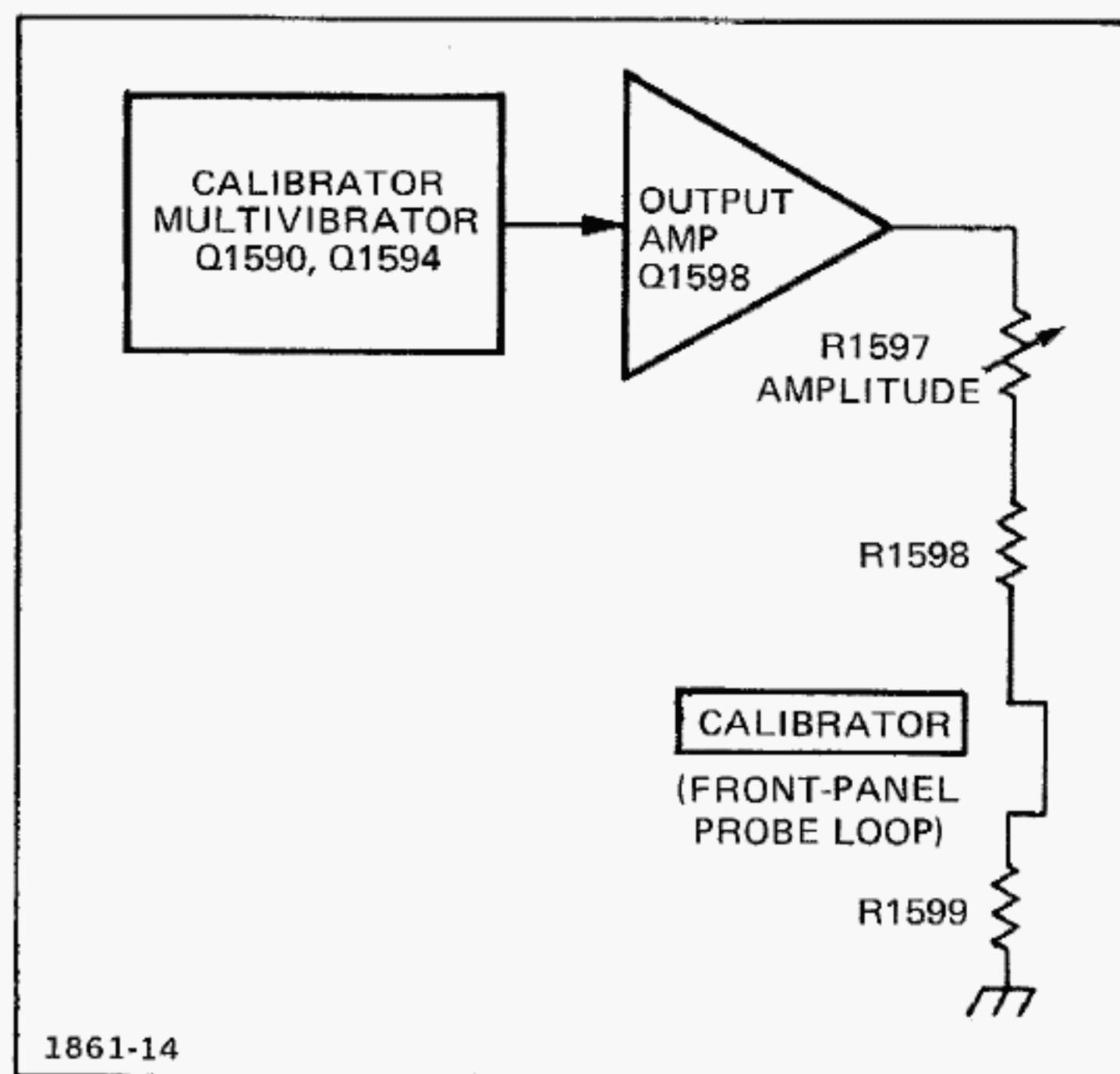

Fig. 3-9. Detailed block diagram of the Calibrator circuit.

CALIBRATOR current loop on the instrument front panel. Fig. 3-9 shows a detailed block diagram of the Calibrator circuit. A schematic of this current is shown on diagram 11 at the back of this manual.

Multivibrator

Q1590 and Q1594 along with their associated circuitry compose an astable multivibrator. The basic frequency of the multivibrator is approximately 1 kilohertz and is essentially determined by the resistor and capacitor combination of C1592, R1591, and R1593. Transistors Q1590 and Q1594 alternately conduct, producing a square-wave output signal, which is taken from the collector of Q1594. The amplitude of the square wave is limited in the negative direction by the base-emitter junction of Q1598 and in the positive direction by CR1596.

Output Amplifier

The output signal from the Multivibrator overdrives Output Amplifier Q1598 to produce an accurate square wave at the output. When the base of Q1598 goes positive, Q1598 is cut off and the collector level drops to ground. When the base goes negative Q1598 is biased into saturation and the collector of Q1598 rises positive to about +5 volts. Amplitude adjustment R1597 adjusts the resistance between the collector of Q1598 and ground to determine the amount of current allowed to flow, which in turn determines the voltage developed across R1599.

A TRIGGER VIEW AMPLIFIER

Introduction

The A Trigger View Amplifier circuit amplifies a sample of the signal present in the A Trigger Generator circuit and passes it on to the Vertical Output Amplifier for display on the crt when the TRIG VIEW pushbutton is pressed. This provides a method of making a quick and convenient check of the signal being used to trigger the A Sweep Generator and is intended primarily to be used to check the signal applied to the A EXTERNAL TRIGGER INPUT connector. Fig. 3-10 shows a detailed block diagram of the A Trigger View Amplifier circuit. A schematic of this circuit is shown on diagram 11 at the back of this manual.

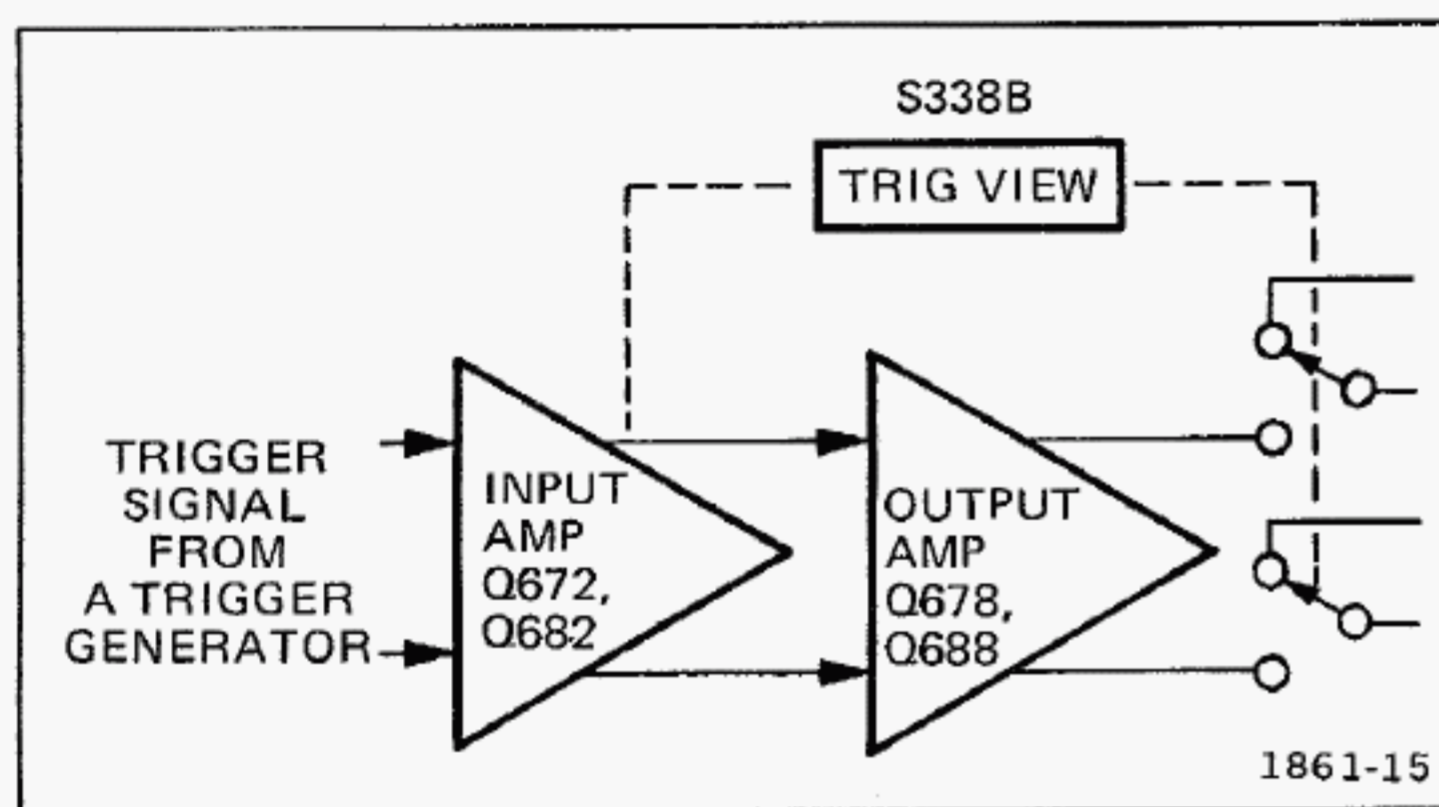

Fig. 3-10. Detailed block diagram of the Trigger View Amplifier.

Amplifier

The amplifier consists of two emitter-coupled push-pull amplifier stages. The emitter source voltage for Q672 and Q682 is switched on and off by the TRIG VIEW pushbutton. With the TRIG VIEW pushbutton not pressed, the emitters of Q672 and Q682 are returned to -8 volts through R691. This reverse-biases the base-emitter junctions of the transistors, preventing any loading of the A Trigger Generator circuit. When the TRIG VIEW pushbutton is pressed, the emitters of Q672 and Q682 are returned to $+15$ volts through R690. This forward biases Q672 and Q682 to allow signal amplification. R675 adjusts for correct dc balance in the circuit.

Normally, the output of the Vertical Switching Amplifier is applied to the input of the Delay Line. When the TRIG VIEW pushbutton is pressed, the signal from the Vertical Switching Amplifier is removed and the output from the A Trigger View Amplifier is applied in its place.

LOW-VOLTAGE POWER SUPPLY

Introduction

The Low-Voltage Power Supply circuit provides the operating power for this instrument from five regulated supplies and one unregulated supply. Electronic regulation is used to provide stable, low-ripple output voltages. Fig. 3-11 shows a detailed block diagram of the Power Supply circuit. A schematic of this circuit is shown on diagram 12 at the back of this manual.

Power Input

Power is applied to the primary of transformer T1501 through Line Fuse F1501, POWER switch S1501, Thermal Cutout S1502, Line Voltage Selector switch S1503, and the Regulating Range Selector Assembly. Line Voltage Selector switch S1503 connects the split primaries of T1501 in parallel for 115 volt nominal operation, or in series for 230 volt nominal operation. Line Fuse F1501 should be changed to the correct value to provide the correct protection for each nominal line voltage. Use a 1.5 ampere fast blow fuse for 115 volt operation or a 0.76 ampere fast blow fuse for 230 volt operation.

The vacant windings between pins 10, 11 and 12 of T1501 are intended for use with the optional Inverter Circuit Board (Option 7). This allows the instrument to be operated from an external dc power source or an 1106 Power Supply.

Secondary Circuit

The -8 volt, $+5$ volt, $+15$ volt, and $+55$ volt supplies are series-regulated supplies. U1524A and B and U1554A and B are 2 channel high-gain amplifier cells with differential inputs. These amplifiers monitor voltage variations in the output voltages and supply correction signals to the series regulating transistors.

Current limiting circuits provide short circuit protection for each of the regulated supplies. The following discusses the $+55$ volt current limit circuit. The other current limiting circuits work in a similar manner.

In the $+55$ volt supply Q1536 is normally biased off. Under normal conditions the base of Q1536 sets at about $+55$ volts. As supply current increases the voltage drop across R1534 increases. This increasing voltage is coupled through the base of Q1534 to the voltage divider

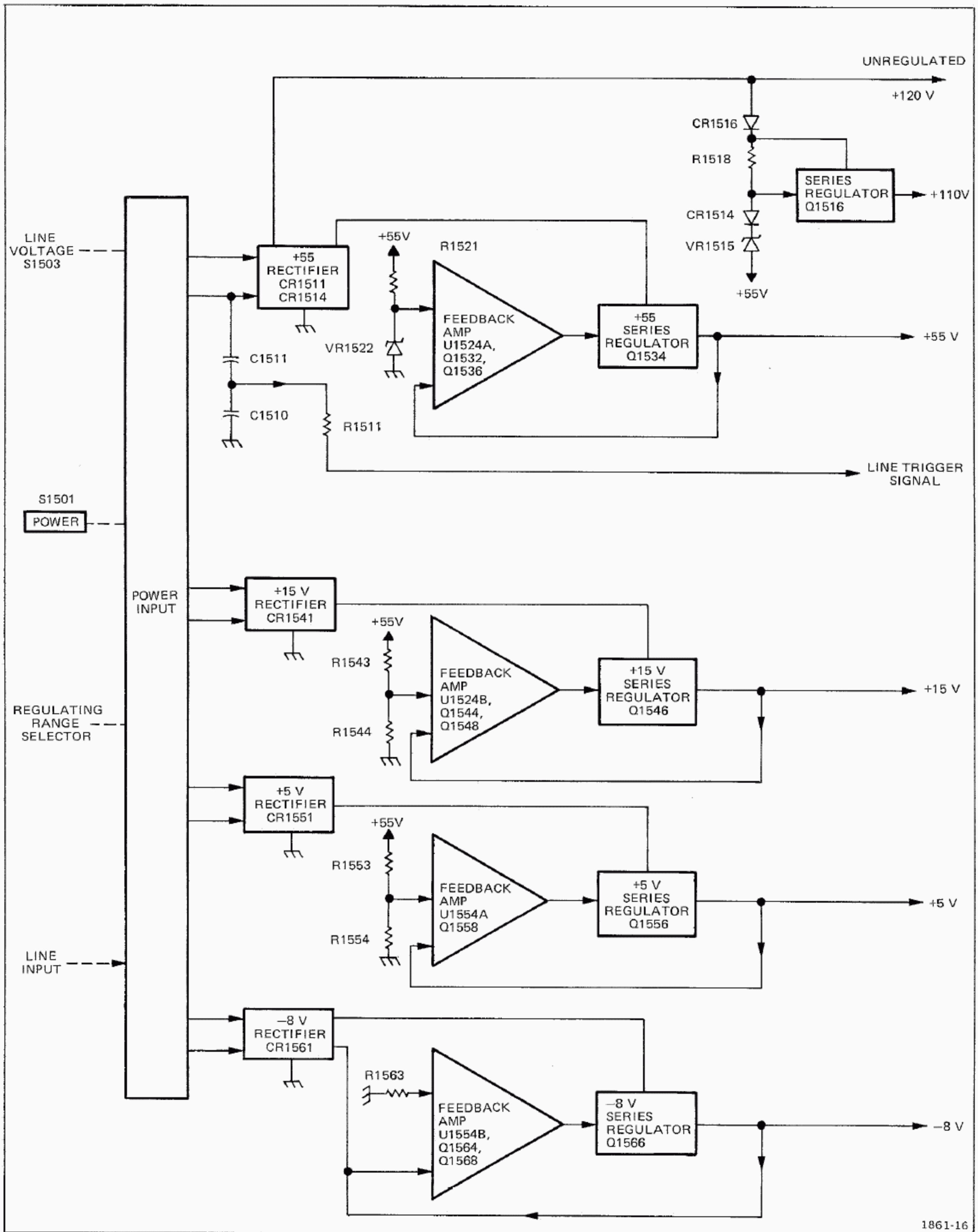

Fig. 3-11. Detailed block diagram of the Low Voltage Power Supply.

Circuit Description—465 Service (SN B250000 & up)

composed of R1532 and R1533 which causes the base of Q1536 to go more positive. When the supply current increases sufficiently Q1536 turns on. The collector of Q1536 moves in the negative direction which begins turning off Q1532 and Q1534. Transistor Q1534 must continue conducting some current when the supply is limited, in order to drop enough voltage across R1534 to keep Q1536 biased on. The supply output voltage can be any value between its regulated value and 0 volt, depending on the load it is trying to supply (see Fig. 3-12). The limiting transistors for the other supplies are:

+15 V	Q1548
+5 V	Q1558
-8 V	Q1568
+110 V	Q1518

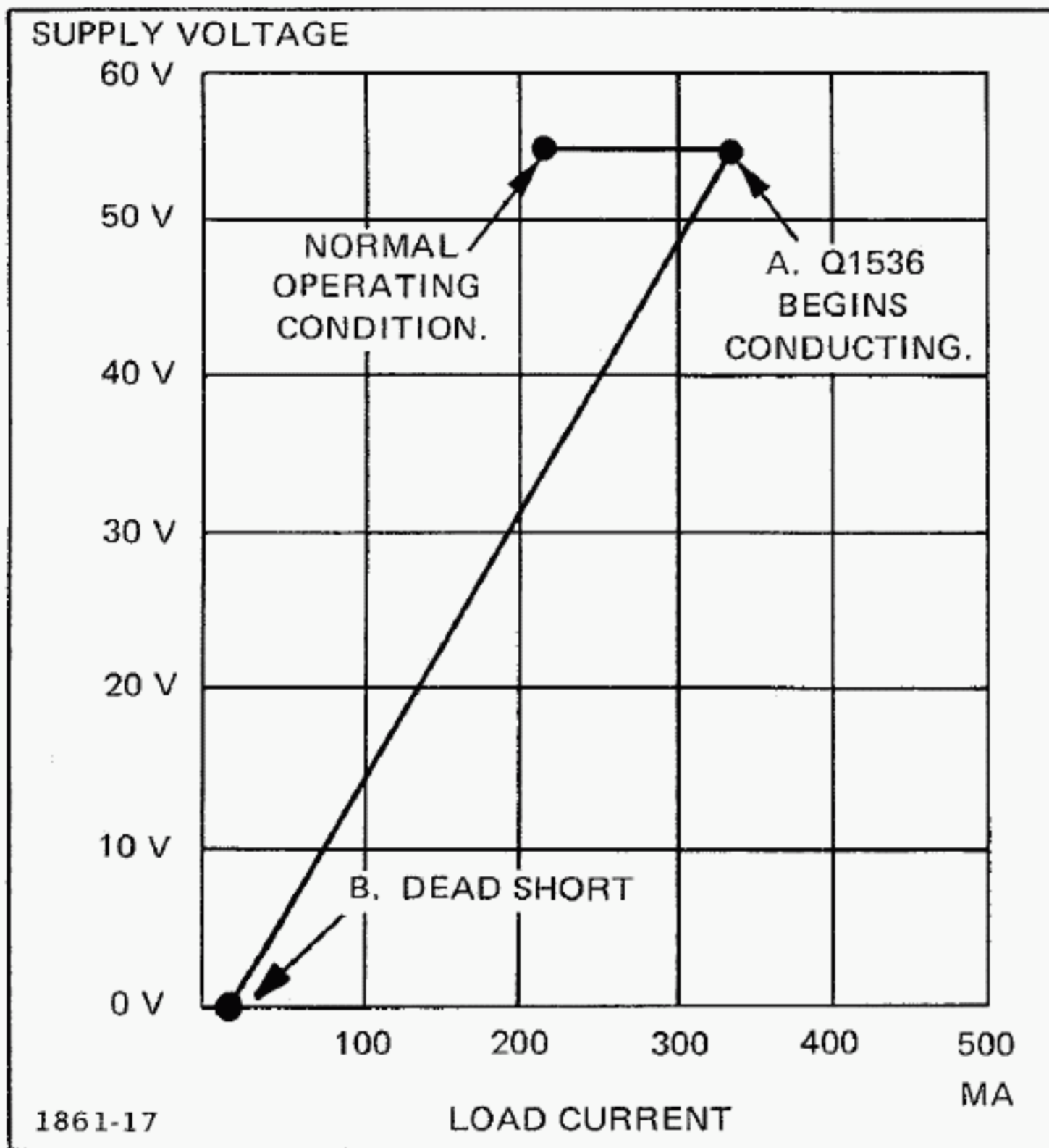

Fig. 3-12. Foldover circuit action.

Fig. 3-12 shows the action of the current limit (foldover) circuit. Q1536 begins conducting at point A. At point B the supply is directly shorted to ground through a current meter.

C1510, C1511, and R1511 compose a wave-shaping circuit that provides a sample of the ac voltage present in the secondary of T1501 to the trigger circuitry for use in the LINE positions of the Trigger SOURCE switches. CR1512 provides a relatively fast discharge path for C1542 when instrument power is turned off.

FAN MOTOR CIRCUIT

The fan motor used in the 465 is a brushless dc fan motor using Hall Effect devices. The fan motor circuitry varies the rotational speed of the fan with variations in operating temperature. When the ambient temperature increases, the value of thermistor RT1696 reduces. This biases Q1698 on harder to conduct more current through the Hall devices. Higher currents through the Hall devices causes the potential difference across them (for instance, between pins 6 and 8 of the fan) to increase. This potential difference biases one of a pair of transistors on and the other off. For instance, if pin 8 is more positive than pin 6 of the fan, Q1690A will be on and Q1690D will be off. The higher the potential difference between pin 8 and pin 6 the harder the on transistor will be conducting. The harder the transistor is conducting, the faster the fan rotates.

MAINTENANCE

Introduction

This section of the manual contains information for use in preventive maintenance, troubleshooting and corrective maintenance.

Cabinet Removal

WARNING

Dangerous potentials exist at several points throughout this instrument. When the instrument is operated with the cover removed, do not touch exposed connections or components. Some transistors may have elevated cases. Disconnect power before cleaning the instrument or replacing parts.

The instrument wrap-around cabinet can be removed in the following manner:

1. Install the front panel cover and set the instrument face on a flat surface.
2. Unwrap the power cord from the instrument feet.
3. Remove the 6 screws indicated in Fig. 4-1 and remove the instrument feet and rear ring assembly from the instrument.
4. Lift the wrap-around cabinet up until the cabinet is separated from the oscilloscope.

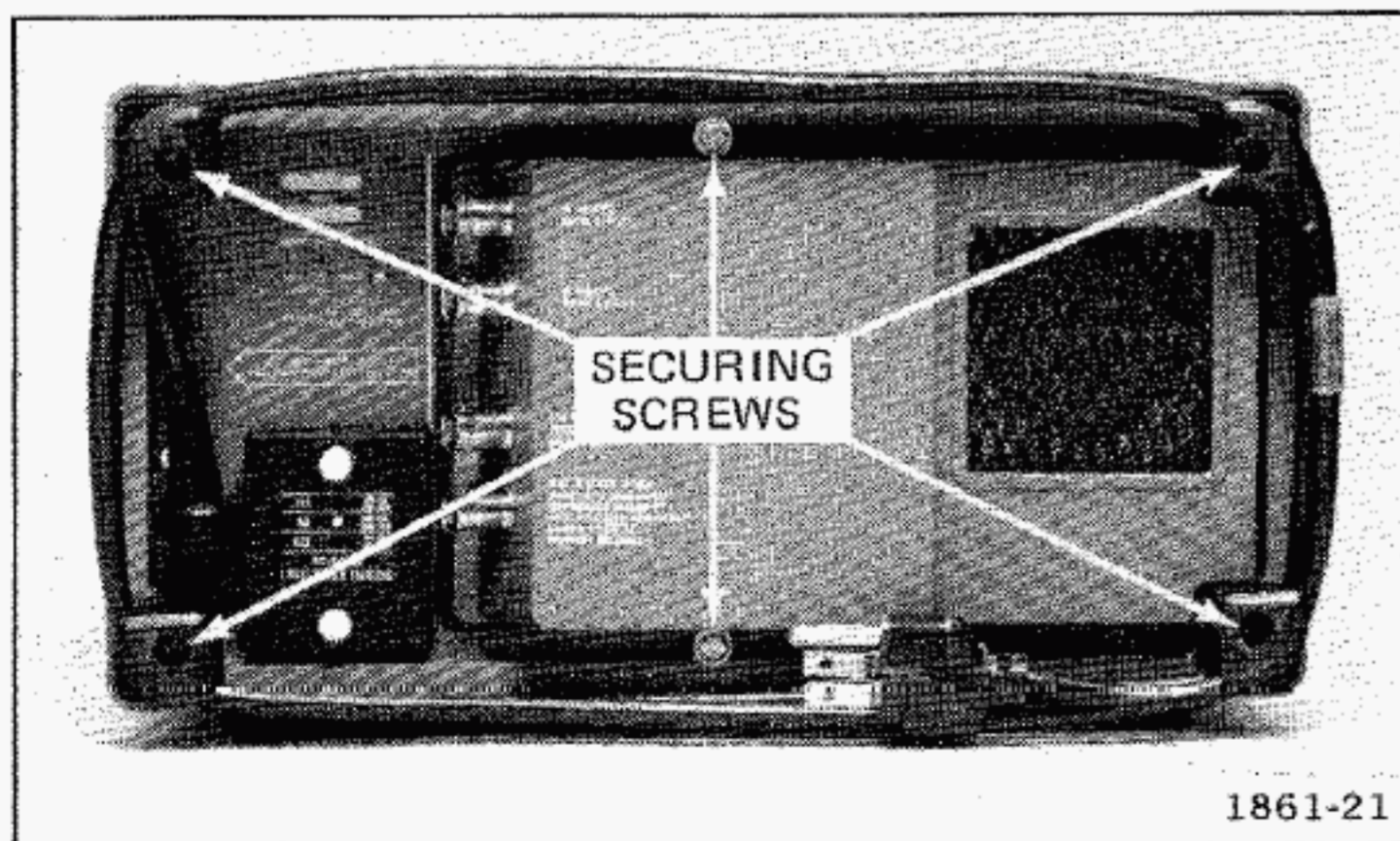

Fig. 4-1. Removing the wrap around cabinet.

To replace the instrument in its wrap-around cabinet, reverse the removal procedure. The portable wrap-around cabinet should be installed with the carrying handle pivot points positioned toward the bottom of the instrument.

PREVENTIVE MAINTENANCE

Introduction

Preventive maintenance consists primarily of cleaning and visual inspection. When performed on a regular basis, preventive maintenance can prevent instrument breakdown and ensure the reliability of this instrument. The severity of the environment to which the 465 is subjected will determine the frequency of maintenance. A convenient time to perform preventive maintenance is just prior to recalibration of the instrument.

Cleaning

The cabinet provides protection against dust in the interior of the instrument. Operation without the cabinet in place necessitates more frequent cleaning. The front cover provides a measure of dust protection for the front panel and the crt face. The front cover should be installed when storing or transporting the instrument.

Interior. Accumulation of dust and dirt should be removed as often as operating conditions require. Dirt can cause overheating and component breakdown. Dirt on components acts as an insulating blanket and prevents efficient heat dissipation. It also provides an electrical conduction path which can result in instrument failure especially under high humidity conditions. The best way to clean the interior is to blow off the accumulated dust with dry, low-pressure air (approximately 9 lb/in²). Remove any dirt which remains with a soft brush or a cloth dampened with a mild detergent and water solution. A cotton-tipped applicator is useful for cleaning in narrow spaces or for cleaning ceramic terminal strips and circuit boards.

CAUTION

Avoid the use of chemical cleaning agents which might damage the plastics used in this instrument. Do not use chemicals which contain acetone, benzene, toluene, xylene, petroleum ether, white kerosene, carbon tetrachloride, methylene chloride, trichloroethane, trichlorotrifluoroethane (freon 113, -tf, -ta, -te, -tmc) and trichlorethylene. Recommended cleaning agents are isopropyl alcohol, kelite (1 part kelite, 20 parts water), and a solution of 1% mild detergent and 99% water. In the absence of these cleaners it is safe to use ethyl alcohol (methanol).

Maintenance—465 Service (SN B250000 & up)

Most spray circuit coolants contain freon 12 as a propellant. Because many freons adversely affect switch contacts, check the contents and brand name before using a spray coolant. Use the following brand names for an acceptable coolant: Artic Freeze, Quik-Freeze, and Can-O-Gas. Do not use Zero Mist brand of circuit coolant. The only recommended circuit coolants are dry ice (CO₂) or isopropyl alcohol.

Switch Contacts. Most of the switching in the 465 is accomplished with circuit-board mounted, cam-actuated contacts. Care must be exercised to preserve the high-frequency characteristics of these switches. Seldom is switch maintenance necessary, but if it is required, observe the following precautions.

Cleaning the switch contacts should only be done using isopropyl alcohol, especially in the area of the vertical attenuator boards. Carbon-based solvents will damage the polyphenylene oxide boards used for the attenuators. Apply the isopropyl alcohol with a camel hair brush. Do not use cotton swabs as they tend to snag on contacts, possibly causing damage, and hold strands of cotton, causing intermittent electrical contact.

Exterior. Loose dust accumulated on the outside of the oscilloscope can be removed with a soft cloth or small paint brush. The paint brush is particularly useful for dislodging dirt on and around the front-panel controls. Dirt which remains can be removed with a soft cloth dampened in a mild solution of detergent and water. Abrasive cleaners should not be used.

CRT. Two plastic light filters, one blue and one clear, are provided with the oscilloscope. Clean the light filter and the crt face with a soft lint-free cloth dampened with denatured alcohol or a mild water and detergent solution. The optional crt mesh filter can be cleaned in the following manner:

1. Hold the filter in a vertical position and brush lightly with a number 7 soft watercolor brush to remove light coatings of dust and lint.
2. Greasy residues or dried-on dirt can be removed with a solution of warm water and a neutral pH liquid detergent. Use the brush to lightly scrub the filter.
3. Rinse the filter thoroughly in clean water and allow to air dry.

4. If any lint or dirt remains, use clean low-pressure air (approximately 9 lb/in²) to remove. Do not use tweezers or other hard cleaning tools on the filter as the special finish may be damaged.

5. When not in use, store the mesh filter in a lint-free dust-proof container such as a plastic bag.

Air Filter. The air filter should be visually checked every few weeks and cleaned or replaced if dirty. More frequent inspections are required under severe operating conditions. The following procedure is suggested for cleaning the filter. If the filter is to be replaced, order new air filters from your local Tektronix Field Office or representative; order by Tektronix Part Number 378-0044-01.

1. Remove the filter by pulling it out of the retaining frame on the rear panel. Be careful not to drop any of the accumulated dirt into the instrument.
2. Flush the loose dirt from the filter with a stream of hot water.
3. Place the filter in a solution of mild detergent and hot water and let it soak for several minutes.
4. Squeeze the filter to wash out any dirt which remains.
5. Rinse the filter in clear water and allow it to dry.
6. Coat the dry filter with an air-filter adhesive (available from air conditioner supplier, or order Tektronix Part Number 006-0580-00).
7. Let the adhesive dry thoroughly.
8. Re-install the filter in the retaining frame.

Visual Inspection

The instrument should be inspected occasionally for such defects as broken connections, broken or damaged ceramic strips, improperly seated semiconductors, damaged or improperly installed circuit boards, and heat-damaged parts.

The corrective procedure for most visible defects is obvious; however, particular care must be taken if heat-damaged components are found. Overheating usually indicates other trouble in the instrument; therefore, it is important that the cause of overheating be corrected to prevent recurrence of the damage.

Lubrication

The fan motor and most of the potentiometers used in the 465 are permanently sealed and generally do not require periodic lubrication. The switches used in the 465, both cam- and lever-type, are installed with proper lubrication applied where necessary and will rarely require any additional lubrication. A regular periodic lubrication program for the 465 is not recommended.

Semiconductor Checks

Periodic checks of the transistors and other semiconductors in the oscilloscope are not recommended. The best check of semiconductor performance is actual operation in the instrument.

Recalibration

To ensure accurate measurements, check the calibration of this instrument after each 1000 hours of operation or every six months if used infrequently. In addition, replacement of components may necessitate recalibration of the affected circuits. The calibration procedure can also be helpful in localizing certain troubles in the instrument. In some cases, minor troubles may be revealed and/or corrected by recalibration. Complete calibration instructions are given in the Calibration section. If only a partial calibration is performed, see the interaction chart, Table 6-1, for possible interactions with circuits not adjusted.

TROUBLESHOOTING

Introduction

The following information is provided to facilitate troubleshooting. Information contained in other sections of this manual should be used along with the following information to aid in locating the defective component. An understanding of the circuit operation is helpful in locating troubles, particularly where integrated circuits are used. See the Circuit Description section for this information.

Troubleshooting Aids

Troubleshooting Charts. As an aid in locating problem areas, troubleshooting charts have been provided for the low voltage power supplies, the —2450 volt power supply, and for a no visible display condition. These can be found on pullout pages in the Diagrams section.

Diagrams. Complete circuit diagrams are given on foldout pages in the Diagrams section. The portions of the circuit mounted on circuit boards are enclosed with blue lines. The component number and electrical value of each component in this instrument are shown on the diagrams (see the first page of the Diagrams section for definition of the reference designators used to identify components in this instrument). Each main circuit is assigned a series of component numbers to assist in identifying which circuit they are in. Important voltages and waveforms are also shown on the diagrams. The physical locations of the waveform test points are shown on the Circuit Board illustrations.

Circuit Board Illustrations. In conjunction with each circuit diagram is a circuit board illustration. These can be found on the back of the pullout page preceding the circuit diagram it relates to. Each circuit component shown on the circuit diagram is identified on the circuit board illustration by its component number. Each circuit board illustration is sectioned by a grid system. A table is provided listing all components on the circuit board illustration with their grid locations to facilitate rapid physical location of any component shown on the circuit diagrams.

Adjustment Locations Illustrations. To aid in locating test points and adjustable components, the adjustment locations pullout pages (normally used with the calibration procedure) permit very rapid location of test points and adjustments because only these components are identified.

Resistor Color-Code. In addition to the brown composition resistors, some metal-film resistors and some wire-wound resistors are used in the 465. The resistance values of wire-wound resistors are usually printed on the body of the component. The resistance values of composition resistors and metal-film resistors are color-coded on the components with EIA color-code (some metal-film resistors may have the value printed on the body). The color-code is read starting with the stripe nearest the end of the resistor. Composition resistors have four stripes which consist of two significant figures, a multiplier, and a tolerance value (see Fig. 4-2). Metal-film resistors have five stripes consisting of three significant figures, a multiplier, and a tolerance value.

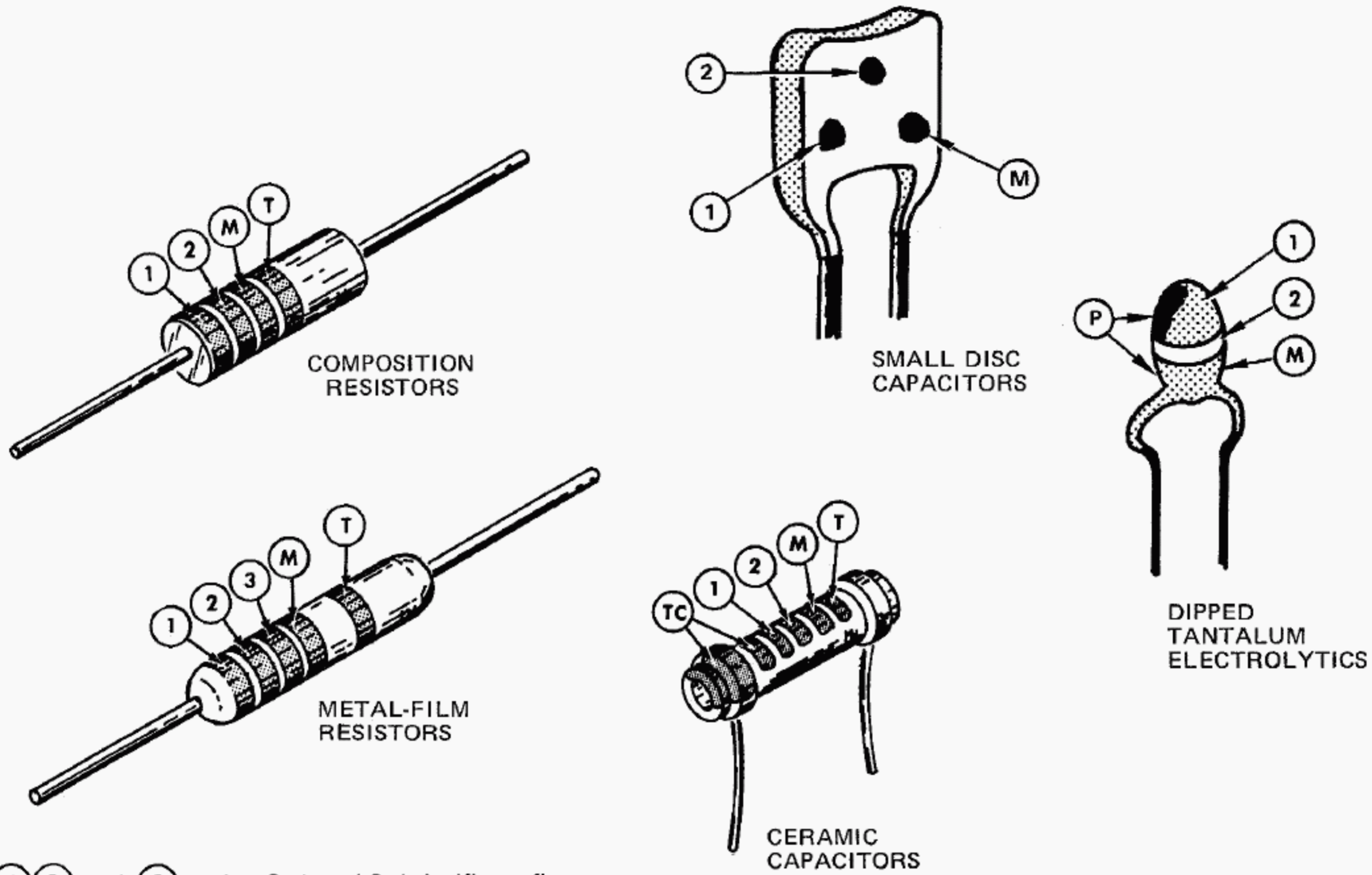

① ② and ③ — 1st, 2nd, and 3rd significant figures

Ⓜ —multiplier Ⓣ —tolerance

ⓉⓈ —temperature coefficient

Ⓟ —polarity and voltage rating

Ⓣ and/or ⓉⓈ color code may not be present on some capacitors

COLOR	SIGNIFICANT FIGURES	RESISTORS		CAPACITORS			DIPPED TANTALUM VOLTAGE RATING
		MULTIPLIER	TOLERANCE	MULTIPLIER	TOLERANCE		
					over 10 pF	under 10 pF	
BLACK	0	1	----	1	±20%	2 pF	4 VDC
BROWN	1	10	±1%	10	±1%	±0.1 pF	6 VDC
RED	2	10 ² or 100	±2%	10 ² or 100	±2%	----	10 VDC
ORANGE	3	10 ³ or 1 K	±3%	10 ³ or 1000	±3%	----	15 VDC
YELLOW	4	10 ⁴ or 10 K	±4%	10 ⁴ or 10,000	+100% -9%	----	20 VDC
GREEN	5	10 ⁵ or 100 K	±½%	10 ⁵ or 100,000	±5%	±0.5 pF	25 VDC
BLUE	6	10 ⁶ or 1 M	±¼%	10 ⁶ or 1,000,000	----	----	35 VDC
VIOLET	7	----	±1/10%	----	----	----	50 VDC
GRAY	8	----	----	10 ⁻² or 0.01	+80% -20%	±0.25 pF	----
WHITE	9	----	----	10 ⁻¹ or 0.1	±10%	±1 pF	3 VDC
GOLD	—	10 ⁻¹ or 0.1	±5%	----	----	----	----
SILVER	—	10 ⁻¹ or 0.01	±10%	----	----	----	----
NONE	—	----	±20%	----	±10%	±1 pF	----

Fig. 4-2. Color codes.

Capacitor Markings. The capacitance values of common disc capacitors and small electrolytics are marked on the side of the component body. The white ceramic capacitors used in the 465 are color-coded in picofarads, using a modified EIA code (see Fig. 4-2). The dipped tantalum capacitors used in the 465 are color-coded in microfarads (see Fig. 4-2). The color dot indicates the positive lead and voltage rating. Be careful to observe the polarity and voltage rating as they are easily destroyed by reverse or over voltage.

Diode Color-Code. The cathode end of each glass-encased diode is indicated by a stripe, a series of stripes, or a dot. For most silicon or germanium diodes with a series of stripes, the color-code identifies the three significant digits of the Tektronix Part Number using the resistor color-code system (e.g., a diode color-coded pink or blue-, brown - gray - green indicates Tektronix Part Number 152-0185-00). The cathode and anode ends of metal-encased diodes can be identified by the diode symbol marked on the body.

Semiconductor Lead Configurations. Typical semiconductor lead configurations are shown at the beginning of the diagrams section.

Troubleshooting Equipment

The following equipment is useful for troubleshooting.

1. Semiconductor Tester

Description: Dynamic-type tester. Must be capable of measuring reverse breakdown voltages of at least 400 volts.

Purpose: To test semiconductors.

Example: Tektronix 576 Curve Tracer or Tektronix 577 (D1 or D2) Curve Tracer with 177 Test Fixture.

2. Test Oscilloscope

Description: Frequency response, dc to at least 100 megahertz; deflection factor, 5 millivolts to 5 volts/division; Input impedance, 1 megohm, 20 picofarads; sweep rate, 0.5 second/division to 0.05 microsecond/division. A 10X, 10 megohm voltage probe should be used to reduce circuit loading for voltage measurements.

Purpose: To check operating waveforms.

Example: Tektronix 465 Oscilloscope with a P6065A 10X probe.

3. Multimeter

Description: Non-loading digital multimeter. Voltmeter, 10 megohm input impedance and 0 to 150 volts range; dc voltage accuracy, within 0.15%; display, 4 1/2 digits. Ohmmeter, 0 to 20 megohms.

Purpose: To check voltages and for general troubleshooting.

4. Variable Autotransformer

Description: Output variable from 0 to 140 volts, 1.2 amperes minimum rating. Must have a 3-wire power cord, plug and receptacle.

Purpose: To vary the input line voltage when troubleshooting in the power supply.

Example: General Radio W 8 MT 3 VM or W 10 MT 3 W Metered Variac Autotransformer.

Troubleshooting Techniques

This troubleshooting procedure is arranged in an order which checks the simple trouble possibilities before proceeding with extensive troubleshooting. The first few checks ensure proper connection, operation and calibration. If the trouble is not located by these checks, the remaining steps aid in locating the defective component. When the defective component is located, it should be replaced following the replacement procedure given under Corrective Maintenance.

1. Check Control Settings. Incorrect control settings can indicate a trouble that does not exist. If there is any question about the correct function or operation of any control, see the Operating Instructions section of this manual.

2. Check Associated Equipment. Before proceeding with troubleshooting, check that the equipment used with this instrument is operating correctly. Check that the signal is properly connected and that the interconnecting cables are not defective. Also, check the power source.

3. Check Instrument Calibration. Check the calibration of this instrument, or the affected circuit if the trouble exists in one circuit. The apparent trouble may only be a result of misadjustment and may be corrected by calibration. Complete calibration instructions are given in the Calibration section of this manual.

4. Visual Check. Visually check the portion of the instrument in which the trouble is located. Many troubles can be located by visible indications such as unsoldered connections, broken wires, damaged circuit boards, damaged components, etc.

5. Isolate Trouble to a Circuit. To isolate trouble to a particular circuit, note the trouble symptom. The symptom often identifies the circuit in which the trouble is located. When trouble symptoms appear in more than one circuit, check the power supplies, then check the affected circuits. If the trouble has been isolated to a power supply follow the Troubleshooting Chart for that supply. The power supplies are interdependent. All the low voltage power supplies depend on +55 volts for reference. If more than one supply appears defective repair them in the following order:

+55 Volt
+110 Volt
+15 Volt
-8 Volt
-2450 Volt

6. Check Circuit Board Interconnections. After the trouble has been isolated to a particular circuit, check for loose or broken connections, improperly seated transistors and heat damaged components.

7. Check Voltages and Waveforms. Often the defective component can be located by checking for the correct voltage or waveform in the circuit. Typical voltages are given on the diagrams. Waveforms are shown at the left of the circuit diagram.

NOTE

Voltages and waveforms given on the diagrams are not absolute and may vary slightly between instruments. To obtain operating conditions similar to those used to take these readings, see the voltage and waveform setup procedures at the beginning of

the Diagrams section. Exceptions to these procedures are noted with the readings to which they apply. Note the recommended test equipment, front panel control settings, voltage and waveform conditions and test equipment cable connection instructions. Voltages and waveforms given on the schematics should be checked against each instrument while it is operating properly. Deviations should be noted on the schematics for later reference.

8. Check Individual Components. The following procedures describe methods of checking individual components. Components which are soldered in place are best checked by disconnecting one end. This isolates the measurement from the effects of surrounding circuitry.

WARNING

The Power switch must be turned off before removing or replacing components.

A. Semiconductors. A good check of transistor operation is actual performance under operating conditions. A transistor can be most effectively checked by substituting a new component for it (or one which has been checked previously). However, be sure that circuit conditions are not such that a replacement transistor might also be damaged. If substitute transistors are not available, use a dynamic tester. Static-type testers are not recommended, since they do not check operation under simulated operating conditions.

When troubleshooting transistors in the circuit with a voltmeter, measure the emitter-to-base and emitter-to-collector voltages to determine if the voltages are consistent with normal circuit voltage. Voltages across a transistor vary with the type of device and its circuit function. Some of these voltages are predictable. The emitter-to-base voltage of a conducting silicone transistor will normally be 0.6 to 0.8 volts. The emitter-to-collector voltage of saturated transistors is approximately 0.2 volts. Because these values are small, the best way to check them is by connecting the voltmeter across the junction and using a sensitive voltmeter setting, rather than by comparing 2 voltages taken with respect to ground (both leads of the voltmeter must be isolated from ground if this method is used). If values less than these are obtained, either the device is short-circuited or no current is flowing in the circuit. If values are in excess of the base-emitter values given, the junction is back-biased or the

device is defective. Values in excess of those given for emitter-collector could indicate either a non-saturated device operating normally, or a defective (open-circuited) transistor. If the device is conducting, voltage will be developed across resistances in series with it; if it is open, no voltage will be developed across resistances in series with it unless current is being supplied by a parallel path.

When troubleshooting field-effect transistors, the voltage across its elements can be checked in the same manner as transistors. However, it should be remembered that normal depletion mode operation has the gate-to-source junction reverse biased, while the enhanced mode has the junction forward biased.

IC's (integrated circuits) can be checked with a voltmeter, test oscilloscope, or by direct substitution. A good understanding of circuit operation is essential to troubleshooting circuits using IC's. Use care when checking voltages and waveforms around the IC's so that adjacent leads are not shorted together. A convenient means of clipping a test probe to the 14- and 16-pin IC's is with an IC test clip. This device also doubles as an extraction tool. Typical semiconductor lead configurations are shown at the beginning of the Diagrams section.

B. Diodes. A diode can be checked for an open or for a short circuit by measuring the resistance between terminals with an ohmmeter set to the R X 1k scale. The diode resistance should be very high in one direction and very low when the meter leads are reversed. Do not check tunnel diodes or back diodes with an ohmmeter.

CAUTION

Do not use an ohmmeter scale that has a high internal current. High currents may damage the diode. Do not measure tunnel diodes with an ohmmeter; use a dynamic tester (such as a Tektronix Type 576 Transistor-Curve Tracer). Checks on diodes can be performed in much the same manner as on transistor emitter-to-base junctions. Silicon diodes should have 0.6 to 0.8 volts across the junction when conducting. Higher readings indicate that they are either back biased or defective, depending on polarity.

C. Resistors. Check the resistors with an ohmmeter. Check the Electrical Parts List for tolerance of the resistors used in this instrument. Resistors normally do not need to be replaced unless the measured value varies widely from the specified value.

D. Inductors. Check for open inductors by checking continuity with an ohmmeter. Shorted or partially shorted inductors can usually be found by checking the waveform response when high-frequency signals are passed through the circuit.

E. Capacitors. A leaky or shorted capacitor can best be detected by checking resistance with an ohmmeter on the highest scale. Do not exceed the voltage rating of the capacitor. The resistance reading should be high after initial charge of the capacitor. An open capacitor can be detected with a capacitance meter or by checking whether the capacitor passes ac signals.

F. Attenuators. The thick film attenuators are best checked by substitution. If only one channel of the 465 is not operating properly, and there is reason to believe an attenuator is defective, replace the suspected attenuator with the same attenuator from the other channel and check instrument operation. If proper operation results, order a new attenuator.

9. Repair and Readjust the Circuit. If any defective parts are located, follow the replacement procedures given in this section. Be sure to check the performance of any circuit that has been repaired or that has any electrical components replaced. Recalibration of the affected circuit may be necessary. Check Table 6-1 for possible adjustment interaction.

CORRECTIVE MAINTENANCE

Introduction

Corrective maintenance consists of component replacement and instrument repair. Special techniques required to replace components in this instrument are given here.

Obtaining Replacement Parts

Standard Parts. All electrical and mechanical part replacements for the 465 can be obtained through your local Tektronix Field Office or representative. However, many of the standard electronic components can be obtained locally in less time than is required to order them from Tektronix, Inc. Before purchasing or ordering replacement parts, check the parts list for value, tolerance, rating and description.

NOTE

Physical size and shape of a component may affect instrument performance, particularly at high frequencies. Always use direct-replacement components, unless it is known that a substitute will not degrade instrument performance.

Special Parts. In addition to the standard electronic components, some special components are used in the 465. These components are manufactured or selected by Tektronix, Inc. to meet specific performance requirements, or are manufactured for Tektronix, Inc. in accordance with our specifications (see Cross Index-Manufacturers Code Number to Manufacture in Electrical Parts List for code numbers). Most of the mechanical parts used in this instrument have been manufactured by Tektronix, Inc. Order all special parts directly from your local Tektronix Field Office or representative.

Ordering Parts. When ordering replacement parts from Tektronix, Inc., it is imperative that all of the following information be included in order to ensure receiving the proper parts.

1. Instrument type (include modification or option numbers).
2. Instrument serial number.
3. A description of the part (if electrical, include the circuit number).
4. Tektronix part number.

Soldering Techniques

WARNING

Always disconnect the instrument from the power source before attempting to solder in the instrument.

Ordinary 60/40 solder and 35- to 40-watt pencil-type soldering iron can be used to accomplish the majority of the soldering. If a higher wattage-rating soldering iron is used on the etched circuit boards, excessive heat can cause the etched circuit wiring to separate from the board base material.

CAUTION

The Vertical Preamplifier Attenuator circuit boards are made of material easily damaged by excessive heat. When soldering to these boards, do not use a soldering iron with a rating of more than approximately 15 watts. Avoid prolonged applications of heat to circuit-board connections. Use only isopropyl alcohol when cleaning this circuit board.

The following technique should be used to replace a component on the circuit board. Most components can be replaced without removing the boards from the instrument.

1. Grip the component lead with long-nose pliers. Touch the soldering iron to the lead at the solder connection. Do not lay the iron directly on the board, as it may damage the board.

2. When the solder begins to melt, pull the lead out gently. This should leave a clean hole in the board. If not, the hole can be cleaned by reheating the solder and placing a sharp object such as a toothpick into the hole to clean it out. A vacuum-type desoldering tool can also be used for this purpose.

3. Bend the leads of the new component to fit the holes in the board. If the component is replaced while the board is mounted in the instrument, cut the leads so they will just protrude through the board. Insert the leads into the holes in the board so the component is firmly seated against the board (or as positioned originally). If it does not seat properly, heat the solder and gently press the component into place.

4. Touch the iron to the connection and apply a small amount of solder to make a firm solder joint. To protect heat-sensitive components, hold the lead between the component body and the solder joint with a pair of long-nose pliers or other heat sink.

5. Clip the excess lead that protrudes through the board (if not clipped in step 3).

6. Clean the area around the solder connection with a flux-remover solvent. Be careful not to remove information printed on the board.

When soldering to the ceramic strips in the instrument a slightly larger soldering iron can be used. It is recommended that a solder containing about 3% silver be used when soldering to these strips to avoid destroying the bond to the ceramic material. This bond can be broken by repeated use of ordinary tin-lead solder or by the application of too much heat; however, occasional use of ordinary solder will not break the bond if excessive heat is not applied.

If it becomes necessary to solder in the general area of any of the high-frequency contacts in the instrument, clean the contacts immediately upon completion of the soldering. Refer to the section entitled Switch Contacts under Preventive Maintenance for recommended cleaners and procedures.

Component Removal and Replacement

WARNING

Always disconnect the instrument from the power source before attempting to replace components.

Circuit Boards. Occasionally it may be necessary to gain access to the reverse side of a circuit board or to remove one circuit board to gain access to another. The following procedures outline the necessary steps to facilitate instrument disassembly. Most of the connections to the circuit boards in the instrument are made with pin connectors. However, some connections are soldered to the board. Observe the soldering precautions given under Soldering Techniques in this section.

Vertical Preamp Assembly. Remove and replace the Vertical Preamp as follows:

1. Remove the instrument wrap-around cabinet in the manner given under Cabinet Removal at the beginning of this section.

2. Remove the knobs from the VOLTS/DIV switches and from the Input Coupling switches. The knobs on the VOLTS/DIV switches must have a set screw in each one loosened (use a 1/16" Allen wrench) before they can be removed, while the knobs on the Input Coupling switches are held on by spring clips and can be pulled off.

3. Disconnect the vertical POSITION control shaft couplers from the vertical POSITION potentiometers (0.50" Allen wrench required).

4. Remove the two uncal light lenses. Pry them away from the front panel with a fingernail and pull them straight out.

5. Disconnect the following cables and wires:

a. Nine coaxial cables (5 on the front and 4 on the back). Make note of cable color-codes to insure proper installation during reassembly.

b. A 6 wire ribbon cable that connects to the Interface board (P300).

c. Delay-line from the rear of the preamplifier board.

d. An eight wire ribbon cable that plugs onto the Vertical Mode Switch circuit board (P390).

e. Ground braid from the front of the preamplifier board to the Interface board near the BEAM FINDER switch shaft.

6. Remove the covers from the attenuators.

7. Unsolder the leads to both input coupling capacitors. Remove the capacitors by unplugging them from the attenuator circuit boards.

8. Remove the 4 nuts securing the attenuator chassis to the instrument front casting (1/4" nutdriver required).

9. Remove the circuit board hold-down screw on the Vertical Mode Switch circuit board (accessible through a hole in the Vertical Preamp circuit board near the Channel 1 POSITION potentiometer; Phillips screwdriver required).

Maintenance—465 Service (SN B250000 & up)

10. Remove the 2 circuit board hold down screws from the rear of the circuit board and the 3/16 inch post from below the Channel 2 POSITION potentiometer.

11. Remove the Vertical Preamp, cam switch assembly, and Vertical Mode Switch Circuit board as a unit. Pull the rear of the Vertical Preamp circuit board outward about 1 or 2 inches; then slide the whole assembly to the rear until the front-panel control shafts clear the front casting.

To reinstall the Vertical Preamp assembly, reverse the order of the removal steps. To align the VERT MODE switch pushbuttons, hold the assembly in place with a slight forward pressure and use some sort of small tool to reach through the front panel to align the buttons. Install the remaining parts in the reverse order they were removed. Do not tighten the circuit board hold-down screws until the securing nuts at the front of the attenuator chassis are tight and the circuit board is aligned properly.

Trigger Generator and Sweep Logic Circuit Board.

Remove and replace the Trigger Circuit Board as follows:

Remove the LOW LINE, READY and TRIG light lenses from the front panel. Pry them away from the front panel with a fingernail and pull straight out.

2. Disconnect the following cables and wires:

a. Eight coaxial cables (5 on the front and 3 on the back). Make note of cable color-codes to ensure proper installation during assembly.

b. Two 5-wire ribbon cables from the Trigger and Level Controls to the Trigger and Sweep Logic circuit board (P530, P630).

c. The red and black wires and the ground braid from the back of the board near P5.

d. The 2 wires midway back on the trigger board near the 3/16" post.

e. The red wire near the front of the trigger board near the 2 coaxial cables from the trigger view amplifier circuit.

3. Unsolder the 2 wires from the circuit board that run to the A TRIG HOLDOFF control through a harnessed cable and the 2 connections to the External Trigger Input connectors. Make note of wire color-codes to ensure proper installation during reassembly.

4. Remove the POWER switch actuator rod from the plastic holder on the switch. Pry the rod out of the holder with a small flat-bladed screwdriver.

5. Remove the POWER switch bracket from the circuit board (1/4" wrench or nutdriver required).

6. Remove 5 mounting screws from the circuit board (2 at rear, 2 at front, and 1 at center (Phillips screwdriver required)).

7. Unplug the Trigger Generator and Sweep Logic circuit board from the Interface board by forcing the Trigger board away at the 2 white interboard connectors at the bottom edge of the Trigger board.

8. Move the Trigger board to the rear until the Trigger switches clear the front casting and then remove the assembly from the instrument. Exercise caution to avoid damaging the connector pins on the Interface board.

To reinstall the Trigger Generator and Sweep Logic circuit board, reverse the order of the removal steps. If the indexing of the Trigger Switches was disturbed, a series of trial-and-error installation-removal-adjustment steps will be necessary to return them to correct alignment.

Sweep Timing Circuit Board. Remove and replace the Sweep Timing circuit board as follows:

1. Remove the Trigger Generator and Sweep Logic circuit board as described previously.

Maintenance—465 Service (SN B250000 & up)

2. Unsolder four wires from the Timing circuit board. Make note of wire color-codes to ensure proper installation during reassembly.

3. Remove the knobs from the VAR TIME/DIV control and B TIME/DIV switches (1/16 Allen wrench required). This Allen screw is accessible from behind the front panel casting.

4. Remove the X10 MAG and the UNCAL light lenses. Pry them away from the instrument front panel with a fingernail and pull straight out.

5. Remove the 4 Interface board mounting screws that are nearest the Sweep Timing circuit board.

6. Remove the board mounting screw and the hex rod from the Sweep Timing circuit board (3/16" wrench or nutdriver required).

7. Use a flat blade screwdriver and pry the Timing board away from the Interface board. Gently pull away the corner of the Interface board near the B EXTERNAL TRIGGER INPUT connector and simultaneously lift up on the Timing board near the rear to fully disengage connector pins from the Interface board.

To reinstall the Timing board, reverse the order of the removal steps.

Power Transformer. If the power transformer becomes defective, be sure to replace only with a direct replacement Tektronix transformer. After the transformer is replaced, check the performance of the complete instrument. The transformer is removed as follows:

1. Unsolder the power cord from the Interface board, the Regulating Range Selector Assembly, and the solder lug on the rear subpanel.

2. Remove the small blue panel from the rear panel of the last instrument. It will be necessary to remove the rear ring assembly, as for cabinet removal (see Fig. 4-1) and the Regulating Range Selector cover to allow removal of the panel.

3. Remove the actuating shaft from the POWER switch coupler. Be careful not to damage the switch coupler.

4. Remove the POWER switch mounting bracket from the Trigger board.

5. Unsolder the transformer leads from the Interface board and the solder lug on the rear subpanel. Note the wire color-codes to facilitate correct re-installation.

6. Remove the transformer leads from the Regulating Range Selector Assembly. It will be necessary to use a special pin removing tool available from Tektronix, Inc. Order Tektronix Part Number 003-0707-00. It is only necessary to use this tool to remove the transformer leads from the Selector Assembly. The leads may be re-installed by simply pushing them into place. Note wire color codes to facilitate correct re-installation.

7. Remove the transformer bracket mounting hardware. This includes two screws on the Trigger board, 1 screw on the Interface board, 3 nuts on the U-channel (1 on the transformer side and 1 on the crt side), and 2 screws and nuts on the rear subpanel.

8. Thoroughly loosen the Trigger board and remove the transformer assembly from the instrument.

9. Remove the thermal cutout and POWER switch from the old transformer and install on the new transformer. Note wire color-codes to facilitate correct installation.

10. Install the new transformer assembly in the instrument reversing the order of the removal steps.

Cathode Ray Tube (crt). Remove and replace the crt as follows:

WARNING

Handle the crt carefully. Rough handling or scratching can cause the crt to implode.

Maintenance—465 Service (SN B250000 & up)

1. Remove the plastic bezel and filter from the front of the crt (held with 4 screws).

2. Remove the feet from the rear of the instrument (held on by 1 screw in each foot accessible through a hole in that foot).

3. Remove the rear ring (held by 2 screws).

4. Remove the rear cover (held by 2 flat head screws).

5. Remove the bell-shaped cover to expose the crt socket (held by 2 screws).

6. Unplug the crt socket.

7. Remove the 2 vertical deflection pins from the left side of the crt neck.

8. Turn the instrument over on its top.

9. Remove the horizontal deflection pins from the bottom of the crt neck (accessible through a hole in the Interface board).

10. Set the instrument on its left side.

11. Disconnect the anode lead from its holder and discharge to the chassis.

12. Holding one hand on the crt face, push slowly on the crt base with the other hand. Guide the anode connector through the crt shield while slowly pulling the crt out of the instrument. The plastic corner pads may fall out during removal; save them for reinstallation.

13. Reverse the above procedure to install a crt. Observe the following precautions:

a. Be sure to guide the anode lead through the hole in the crt shield while pushing the crt into the instrument.

b. Be sure the plastic corner pads are securely seated.

c. Be sure the plastic centering ring firmly centers the crt neck. Reposition the ring as necessary.

High Voltage Multiplier. Remove and replace the High Voltage Multiplier as follows:

1. Remove the Vertical Preamp board and crt as described previously.

2. Slide the round part of the crt shield to the rear about 2 inches.

3. Remove the high voltage shield (held on by four screws).

4. Remove the four 3/16 inch studs to which the high voltage shield as secured.

5. Remove the mounting screw from Q1566 and Q1534 at the rear of the Interface board.

6. Remove the circuit board hold down screw just forward of P1446 on the Interface board.

7. Remove the high voltage transformer and high voltage multiplier shield (one piece held by 2 screws).

8. Unsolder the black wire (between the High Voltage Multiplier and the Interface board) from the Interface board.

9. Unsolder the diode and the wire from the post on the High Voltage Multiplier.

10. Remove the 2 nylon nuts securing the High Voltage Multiplier to the Interface board.

11. Remove the High Voltage Multiplier (carefully pry up on the Interface board as necessary to facilitate removal).

12. Reverse the above procedure to install the High Voltage Multiplier.

Transistors and Integrated Circuits. Transistors and IC's (integrated circuits) should not be replaced unless they are actually defective. If removed from their sockets during routine maintenance return them to their original sockets. Unnecessary replacement or switching of semiconductor devices may affect the calibration of the instrument. When a transistor is replaced, check the operation of the part of the instrument that may be affected.

Any replacement component should be of the original type or a direct replacement. Bend the leads to fit the socket and cut the leads to the same length as on the component being replaced. See Fig. 8-1 for basing diagrams.

An extracting tool should be used to remove the 14, 16, and 20 pin integrated circuits to prevent damage to the pins. This tool is available from Tektronix, Inc. Order Tektronix Part Number 003-0619-00. If an extracting tool is not available when removing one of these integrated circuits, pull slowly and evenly on both ends on the device. Try to avoid having one end of the integrated circuit disengage from the socket before the other, since this may damage the pins.

WARNING

Handle silicone grease with care. Avoid getting silicone grease in the eyes. Wash hands thoroughly after use.

WARNING

Voltages are present on the exterior surface of the chassis-mounted power supply transistors if the power is applied to the instrument and the POWER switch is on.

The chassis-mounted power supply transistors and their mounting bolts are insulated from the chassis. In addition, silicone grease is used to increase heat transfer capabilities. Re-install the insulators and replace the silicone grease when replacing these transistors. The grease should be applied to both sides of the mica insulators, and should be applied to the bottom side of the transistor where it comes in contact with the insulator.

NOTE

After replacing a power transistor, check that the collector is not shorted to ground before applying power.

Interconnecting Pins. Two methods of interconnection are used in this instrument to connect the circuit boards with other boards and components. When the interconnection is made with a coaxial cable, a special end-lead connector plugs into a socket on the board. Other interconnections are made with a pin soldered onto the board. Two types of mating connections are used for these interconnecting pins. If the mating connector is on the end of a lead, an end-lead pin connector is used which mates with the interconnecting pin. The following information provides the replacement procedure for the various types of interconnecting methods:

a. **Coaxial-Type End-Lead Connectors.** Replacement of the coaxial-type end-lead connectors requires special tools and techniques; only experienced maintenance personnel should attempt replacement of these connectors. It is recommended that the cable or wiring harness be replaced as a unit. For cable or wiring harness part numbers, see the Mechanical Parts List. An alternative solution is to refer the replacement of the defective connector to your local Tektronix Field Office or representative.

NOTE

A circuit-board pin replacement kit including necessary tools, instructions, and replacement pins is available from Tektronix, Inc. Order Tektronix Part Number 040-0542-00.

b. **Circuit-Board Pins.** To replace a pin which is mounted on a circuit board, first disconnect any pin connectors. Then, unsolder the damaged pin and

Maintenance—465 Service (SN B250000 & up)

pull it out of the circuit board with a pair of pliers. Be careful not to damage the wiring on the board with too much heat. Ream out the hole in the circuit board with a 0.031-inch drill. Remove the ferrule from the new interconnecting pin and press the new pin into the hole in the circuit board. Position the pin in the same manner as the old pin. Then solder the pin on both sides of the circuit board. If the old pin was bent at an angle to mate with a connector, bend the new pin to match the associated pins.

c. **Circuit Board Pin Sockets.** The pin sockets on the circuit boards are soldered to the rear of the board. To replace one of these sockets, first unsolder the pin (use a vacuum-type desoldering tool to remove excess solder). Then straighten the tabs on the socket and remove it from the hole in the board. Place the new socket in the circuit board hole and press the tabs down against the board. Solder the tabs of the socket to the circuit board; be careful not to get solder into the socket.

NOTE

The spring tension of the pin sockets ensures a good connection between the circuit board and the pin. This spring tension can be destroyed by using the pin sockets as a connecting point for spring-loaded probe tips, alligator clips, etc.

d. **End-Lead Pin Connectors.** The pin connectors used to connect the wires to the interconnecting pins are clamped to the ends of the associated leads. To replace damaged end-lead pin connectors, remove the old pin connector from the end of the lead and clamp the replacement connector to the lead.

Some of the pin connectors are grouped together and mounted in a plastic holder; the overall result is that these connectors are removed and installed as a multi-pin connector. To provide correct orientation of this multi-pin connector when it is replaced, an arrow is stamped on the circuit board and a matching arrow is molded into the plastic housing of the multi-pin connector. Be sure these arrows are aligned as the multi-pin connector is replaced. If the individual end-lead pin connectors are removed from the plastic holder, note the color of the individual wires for replacement.

Ceramic Terminal Strips. Replacement strips (including studs) and spacers are supplied under separate part numbers. However, the old spacers may be re-used if they are not damaged. The applicable Tektronix Part Numbers for the ceramic strips and spacers used in this instrument are given in the Mechanical Parts List.

Remove ceramic terminal strips as follows:

1. Unsolder all components and connections on the strip. To aid in replacing the strip, it may be advisable to mark each lead or draw a sketch to show location of the components and connections.
2. Pry or pull the damaged strip from the chassis.
3. If the spacers come out with the strip, remove them from the stud pins for use on the new strip (spacers should be replaced if they are damaged).

Replace ceramic terminal strips as follows:

1. Place the spacers in the chassis holes.
2. Carefully press the studs of the strip into the spacers until they are completely seated.
3. If the stud extends through the spacers, cut off the excess.
4. Replace all components and connections. Observe the soldering precautions under Soldering Techniques in this section.

Recalibration After Repair

After any electrical component has been replaced, the calibration of that particular circuit should be checked, as well as the calibration of other closely related circuits. Since the power supply affects all circuits, calibration of the entire instrument should be checked if work has been done in the power supply or if the transformer has been replaced.

Instrument Repackaging

If the instrument is to be shipped for long distances by commercial transportation, it is recommended that the instrument be repackaged in the original manner for maximum protection. The original shipping carton can be saved and used for this purpose. The Repackaging illustration in the Mechanical Parts Illustrations shows how to repackage the instrument and gives the part numbers for the repackaging components. New shipping cartons can be obtained from Tektronix, Inc. Contact your local Tektronix Field Office or representative.

PERFORMANCE CHECK

Purpose

The following procedure is intended to be used for incoming inspection to determine the acceptability of newly purchased or recently recalibrated instruments. This procedure does not check every facet of the instrument's calibration; rather it is concerned primarily with those portions of the instrument that are essential to measurement accuracy and correct operation. Removing the instrument's dust cover is not necessary to perform this procedure. All checks are made from the front panel.

NOTE

If a complete check of every facet of the instrument's operation is desired, perform the calibration procedure eliminating the ADJUST portion of the Check/Adjust steps.

Limits and Tolerances

All limits and tolerances given in this procedure are performance guides and should not be interpreted as specifications unless they are found in the specifications section of this manual.

Line Voltage Selection

This procedure is for 115 V ac line, medium range. If a different range is to be used, set the Regulating Range Selector and Line Voltage Selector for the available line voltage (see Item 42 under controls and connectors in section 2).

Equipment Required

The following equipment is required to perform a complete Performance Check. For equipment specifications, usage, and recommended types see Table 6-2 in the Calibration section.

1. Calibration Generator
2. Square-wave Generator
3. Leveled Sine-wave Generator
4. Time-mark Generator
5. 42 Inch, 50-ohm BNC Cable (2 Required)
6. Dual Input Coupler (2 Required)

7. GR to BNC Female Adapter
8. X10 BNC Attenuator
9. X2 BNC Attenuator
10. 50-ohm BNC Termination (2 Required)
11. 20-picofarad RC Input Normalizer
12. 50-ohm Signal Pickoff Unit (Type CT-3)

Special Fixtures

Special fixtures are used only where they simplify the test setup and procedure. These fixtures are available from Tektronix Inc. Order by part number through your local Tektronix Field Office or representative.

Test Equipment Alternatives

When equipment other than that recommended is used, control settings or test setup might need to be altered. If the exact item of equipment given as an example in the Test Equipment list is not available, first check the specifications column carefully to see if any other equipment might suffice. Then check the Usage column to see what this item is used for. If used for a check that is of little or no importance to your measurement requirements, the item and corresponding steps can be deleted.

INDEX TO PERFORMANCE CHECK

Vertical

- | | |
|--|-----|
| 1. Check Trace Rotation | 5-3 |
| 2. Check Alternate Mode | 5-3 |
| 3. Check Chop Mode | 5-3 |
| 4. Check CH 1 Balances | 5-4 |
| 5. Check CH 2 Balances | 5-4 |
| 6. Check Position Range and Centering | 5-4 |
| 7. Check Beam Finder Operation | 5-4 |
| 8. Check Ch 1 and Ch 2 Deflection Factor | 5-5 |
| 9. Check Ch 1 and Ch 2 Variable Volts/Division Range | 5-5 |

Performance Check—465 Service (SN B250000 & up)

- 10. Check Output Amplifier Low Frequency Compensation 5-5
- 11. Check Ch 1 and Ch 2 Volts/Division Compensation 5-5
- 12. Check Ch 1 and Ch 2 Transient Response 5-6
- 13. Check Ch 1 and Ch 2 Bandwidth 5-6
- 14. Check Cascade Gain and Bandwidth 5-6

Triggers

- 1. Check A and B Internal Triggering 5-7
- 2. Check A and B External Triggering 5-8
- 3. Check A Normal Mode 5-8
- 4. Check Single Sweep 5-8

- 5. Check Trigger View 5-9

Horizontal

- 1. Check A and B Time/Division Accuracy 5-10
- 2. Check A Variable Time/Division Range 5-11
- 3. Check Delay or Differential Time Linearity 5-11
- 4. Check Delay or Differential Time Accuracy 5-11
- 5. Check Delay or Differential Jitter 5-12
- 6. Check Mixed Sweep Accuracy 5-12
- 7. Check A Intensified and B ENDS A Operation 5-12
- 8. Check X Gain 5-12
- 9. Check X Bandwidth 5-13

VERTICAL

Equipment Required

- | | |
|------------------------------------|-------------------------------------|
| 1. Calibration Generator | 5. GR to BNC Female Adapter |
| 2. Square-wave Generator | 6. 50 ohm BNC Termination |
| 3. Leveled Sine-Wave Generator | 7. 20 picofarad RC Input Normalizer |
| 4. 42 Inch, 50 ohm BNC Cable (two) | 8. X10 BNC Attenuator |

465 CONTROL SETTINGS

POWER ON

CRT

INTENSITY As desired
 FOCUS Best focused display
 SCALE ILLUM As desired

Vertical (CH 1 and CH 2)

VERT MODE CH 1
 POSITION Midrange
 VOLTS/DIV 5 mV
 VAR VOLTS/DIV Calibrated detent
 AC-GND-DC GND
 INVERT Normal (button out)
 20 MHz BW (Pull) Full bandwidth (no yellow showing)

Trigger (A and B)

COUPLING AC
 LEVEL Midrange
 SLOPE +
 SOURCE NORM
 TRIG MODE AUTO
 A TRIG HOLDOFF NORM

Sweep (A and B)

HORIZ DISPLAY A
 TIME/DIV 1 ms
 VAR TIME/DIV Calibrated detent
 DELAY TIME POSITION Fully counterclockwise
 X10 MAG Off (button out)
 POSITION (Horizontal) Midrange
 FINE Midrange

1. Check Trace Rotation

a. Position the trace to the center horizontal graticule line.

b. Check that the trace is parallel with the center horizontal graticule line. Readjust TRACE ROTATION if necessary (Front panel screwdriver adjustment).

2. Check Alternate Mode

a. Set:

VERT MODE	ALT
A TRIGGER LEVEL	Fully clockwise
AG-GND-DC (both)	GND

b. Position the traces 2 divisions apart.

c. CHECK—The sweeps alternate in all settings of the TIME/DIV switch except X-Y.

3. Check Chop Mode

a. Set:

TIME/DIV	1 μ s
A SOURCE	NORM
VERT MODE	CHOP

b. Position the two traces about 4 divisions apart.

c. Adjust A LEVEL control for a stable display.

d. CHECK—Duration of one cycle is about 4 μ s.

CHECK—Display for blanking of switching transients.

Performance Check—465 Service (SN B250000 & up)

4. Check Ch 1 Balances

a. Set:

VERT MODE	CH 1
CH 1 VOLTS/DIV	20 mV

b. Position the trace to the center horizontal graticule line.

c. CHECK Step Attenuator Balance—Trace shift is 0.2 division or less as the CH 1 VOLTS/DIV switch is rotated from 20 mV to 5 mV.

d. Position the trace to the center horizontal graticule line.

e. CHECK Variable Balance—Trace shift is 1.0 division or less as the CH 1 VAR VOLTS/DIV control is rotated from extreme to extreme.

CHECK—CH 1 UNCAL light comes on when the VAR control is out of the detent position.

5. Check Ch 2 Balances

a. Set:

VERT MODE	CH 2
CH 2 VOLTS/DIV	20 mV

b. Position the trace to the center horizontal graticule line.

c. CHECK Step Attenuator Balance—Trace shift is 0.2 division or less as the CH 2 VOLTS/DIV switch is rotated from 20 mV to 5 mV.

d. Position the trace to the center horizontal graticule line.

e. CHECK Variable Balance—Trace shift is 1.0 division or less as the CH 2 VAR VOLTS/DIV control is rotated from extreme to extreme.

CHECK—CH 2 UNCAL light comes on when the VAR control is out of the detent position.

f. Position the trace to the center horizontal graticule line.

g. CHECK Invert Balance—Trace shift is 2 divisions or less when switching from normal to INVERT.

6. Check Position Range and Centering

a. Set:

VOLTS/DIV (both)	20 mV
AC-GND-DC (both)	AC
A TRIGGER LEVEL	Fully clockwise
INVERT	Normal (button out)

b. Connect a 500 millivolt standard amplitude signal to CH 2 input.

c. CHECK—Top of the display can be positioned at least 0.5 division below and the bottom of the display can be positioned at least 0.5 division above the center horizontal graticule line.

d. Move the 500 millivolt signal to the CH 1 input and set the VERT MODE switch to CH 1.

e. Repeat the CHECK in step c for CH 1.

7. Check Beam Finder Operation

a. Push in and hold the BEAM FINDER button.

b. CHECK—A compressed trace is visible regardless of the settings of the:

CH 1 POSITION control

INTENSITY control

horizontal POSITION control

c. Return the horizontal POSITION control and the INTENSITY control to midrange.

d. While still holding in the BEAM FINDER button, vertically position the trace to the center horizontal graticule line.

e. Release the BEAM FINDER button.

f. CHECK—Trace remains within the graticule area.

8. Check Ch 1 and Ch 2 Deflection Factor

a. Connect a 20 millivolt standard amplitude signal from the calibration generator to the CH 1 input and set both AC-GND-DC switches to DC.

b. CHECK—CH 1 deflection factor is within the limits given in Table 5-1.

c. Set the VERT MODE switch to CH 2.

d. CHECK—CH 2 deflection factor is within the limits given in Table 5-1.

TABLE 5-1

VOLTS / DIV Switch Setting	Standard Amplitude Signal	Vertical Deflection in Divisions	3% Tolerance in Divisions
5 mV	20 mV	4	3.88 to 4.12
10 mV	50 mV	5	4.85 to 5.15
20 mV	0.1 V	5	4.85 to 5.15
50 mV	0.2 V	4	3.88 to 4.12
0.1 V	0.5 V	5	4.85 to 5.15
0.2 V	1.0 V	5	4.85 to 5.15
0.5 V	2.0 V	4	3.88 to 4.12
1.0 V	5.0 V	5	4.85 to 5.15
2.0 V	10.0 V	5	4.85 to 5.15
5.0 V	20.0 V	4	3.88 to 4.12

9. Check Ch 1 and Ch 2 Variable Volts/Division Range

a. Set the CH 1 and CH 2 VOLTS/DIV switches to 20 mV.

b. Adjust the calibration generator for a 0.1 volt standard amplitude signal.

c. CHECK—Display reduces to less than 2 divisions when the CH 2 VAR VOLTS/DIV control is turned to its extreme counterclockwise position.

d. Move the signal to the CH 1 input and set the VERT MODE switch to CH 1.

e. CHECK—Repeat step c using the CH 1 VAR VOLTS/DIV control.

f. Return the VAR controls to the detent position and remove the signal from the CH 1 input.

10. Check Output Amplifier Low Frequency Compensation

a. Set:

TIME/DIV (both) 0.2 ms
VOLTS/DIV (both) 5 mV

b. Connect the fast-rise + output of the square-wave generator to the CH 1 input via a GR to BNC adapter, 50 ohm BNC cable, X10 BNC attenuator and 50 ohm BNC termination.

c. Adjust the square-wave generator for a 5 division, 1 kilohertz display. Adjust A LEVEL control for a stable display.

d. CHECK—Rolloff or overshoot is within 3% (0.15 division) at the frequencies listed in Table 5-2.

**TABLE 5-2
LOW FREQUENCY
COMPENSATION SETUP**

Square-Wave Generator Frequency	TIME / DIV Switch Setting
1 kHz	0.2 ms
10 kHz	20 μ S
100 kHz	2 μ S

11. Check Ch 1 and Ch 2 Volts/Division Compensation

a. Add a 20 picofarad normalizer between the 50-ohm BNC termination and the CH 1 input.

b. Move the test setup from the fast-rise output to the high amplitude output of the square-wave generator.

c. Set the TIME/DIV switch to 0.2 ms and adjust the square-wave generator for a 5 division, 1 kilohertz display.

d. CHECK—Rolloff or overshoot is within 3% (0.15 division) at all settings of the VOLTS/DIV switch between 5 mV and 0.5 V. Adjust the square-wave generator and add or remove attenuators as necessary to maintain 5 divisions of display.

e. Move the test setup to CH 2 and set the VERT MODE switch to CH 2.

f. CHECK—Repeat step d.

Performance Check—465 Service (SN B250000 & up)

12. Check Ch 1 and Ch 2 Transient Response

a. Set:

A TIME/DIV (both)	0.05 μ s
A TRIGGER SLOPE	+

b. Remove the 20 picofarad normalizer from the test setup. Move the test setup to the fast-rise, + output of the square-wave generator. Set the square-wave generator for a 100 kilohertz signal. Adjust the square-wave generator and add or remove attenuators as needed to maintain 5 divisions of display.

c. CHECK—Flat-top waveform within 3% or less (0.15 division) for the 5 mV, 10 mV and 20 mV positions of the VOLTS/DIV switch.

d. Move the test setup to CH 1 and set the VERT MODE switch to CH 1.

e. CHECK—Repeat step c.

f. Disconnect the test setup.

13. Check Ch 1 and Ch 2 Bandwidth

a. Set:

VOLTS/DIV (both)	5 mV
A TIME/DIV	0.2 ms
A TRIGGER LEVEL	fully clockwise

b. Connect the output of the leveled sine-wave generator to the CH 1 input via a 50 ohm BNC cable, X10 BNC attenuator and 50 ohm BNC termination.

c. Adjust the sine-wave generator for a 5 division, 50 kilohertz reference signal. Change the generator frequency to 100 megahertz.

CHECK—Display amplitude is 3.5 divisions or greater.

d. Repeat step c for all CH 1 and CH 2 VOLTS/DIV settings from 5 mV to 0.5 V. Adjust the generator and add or remove attenuators as needed to maintain a 5 division, 50 kilohertz reference signal.

e. Move the sine-wave generator output to the CH 2 input.

f. Repeat step c for all CH 2 VOLTS/DIV settings from 5 mV to 0.5 V.

g. Remove the test setup.

14. Check Cascade Gain and Bandwidth

a. Set:

VOLTS/DIV (both)	5 mV
TIME/DIV	1 ms
VERT MODE	CH 2

b. Connect the CH 1 OUT (on the rear panel) to the CH 2 input via a 50 ohm BNC cable and a 50 ohm BNC termination.

c. Connect a 5 mV standard amplitude signal from the calibration generator to CH 1 via a 50 ohm BNC cable.

d. CHECK—Display amplitude is 5 divisions or greater.

e. Remove the calibration generator signal from the CH 1 input.

f. Connect the output of the leveled sine-wave generator to the CH 1 input via a 50 ohm BNC cable, X10 BNC attenuator and 50 ohm BNC termination. Adjust the generator for a 5 division, 50 kilohertz display reference signal. Adjust the generator to 50 megahertz.

g. CHECK—Display amplitude is 3.5 divisions or greater.

TRIGGERS

Equipment Required

- | | |
|--|--|
| <ol style="list-style-type: none"> 1. Leveled Sine-Wave Generator 2. Calibration Generator 3. 42 Inch BNC Cable (2 required) 4. GR to BNC Female Adapter | <ol style="list-style-type: none"> 5. 50-ohm Signal Pickoff Unit (Type CT-3) 6. X10 BNC Attenuator 7. X2 BNC Attenuator 8. 50-ohm BNC Termination (2 required) 9. Dual Input Coupler (2 required) |
|--|--|

465 Control Settings

POWER	ON
	CRT
INTENSITY	As desired
FOCUS	Best focused display
SCALE ILLUM	As desired

Vertical (CH 1 and CH 2)

VERT MODE	CH 1
POSITION	Midrange
VOLTS/DIV	5 mV
VAR VOLTS/DIV	Calibrated detent
AC-GND-DC	DC
INVERT	Normal (button out)
20 MHz BW (Pull)	Full bandwidth (No yellow showing)

Trigger (A and B)

COUPLING	AC
LEVEL	Midrange
SLOPE	+
SOURCE	NORM
TRIG MODE	AUTO
A TRIG HOLDOFF	NORM

Sweep (A and B)

HORIZ DISPLAY	A
TIME/DIV	5 μ s
VAR TIME/DIV	Calibrated detent
DELAY TIME POSITION	Fully counterclockwise
X10 MAG	Off (button out)
POSITION (horizontal)	Midrange
FINE	Midrange

1. Check A and B Internal Triggering

a. Connect the output of the leveled sine-wave generator to the A and B EXT trigger inputs via a 50 ohm signal pickoff unit (Type CT-3) THRU SIG OUT output, GR to BNC female adapter, 50 ohm BNC Cable, 2X BNC attenuator, 10X BNC attenuator, 50 ohms BNC termination and dual input coupler.

b. Connect the SIG OUT 10% on the CT-3 to the CH 1 and CH 2 inputs via a 50 ohm BNC cable, 50 ohm BNC termination and dual input coupler.

c. Adjust the leveled sine-wave generator for either a 3 division, 50 kilohertz display and set both VOLTS/DIV switches to 50 mV (0.3 division of display), or a 5 division, 50 kilohertz display and set both VOLTS/DIV switches to 50 mV (0.5 division display) as necessary for parts d and f of step 1.

d. CHECK—Stable display can be obtained by adjusting the A LEVEL control in the following A COUPLING and A SOURCE switch positions:

A COUPLING	A SOURCE	DISPLAY
AC	NORM, CH 1, CH 2	0.3 Div
DC	NORM, CH 1, CH 2	0.3 Div
LF REJ	NORM, CH 1, CH 2	0.5 Div
HF REJ	NORM, CH 1, CH 2	0.5 Div

e. Set:

HORIZ MODE	B DLY'D
A LEVEL	Fully clockwise

f. CHECK—Stable display can be obtained by adjusting the B LEVEL control in the following B COUPLING and B SOURCE switch positions:

B COUPLING	B SOURCE	DISPLAY
AC	NORM, CH 1, CH 2	0.3 Div
DC	NORM, CH 1, CH 2	0.3 Div
LF REJ	NORM, CH 1, CH 2	0.5 Div
HF REJ	NORM, CH 1, CH 2	0.5 Div

Performance Check—465 Service (SN B250000 & up)

2. Check A and B External Triggering

a. Set:

CH 1 VOLTS/DIV	20 mV
A & B SOURCE	EXT

b. Adjust the leveled sine-wave generator for 5 divisions of display.

c. CHECK—Stable display can be obtained by adjusting the B LEVEL control in the following B COUPLING switch positions:

AC, DC

d. Remove the X2 BNC attenuator and set the B COUPLING switch to LF REJ then HF REJ.

e. CHECK—Stable display can be obtained by adjusting the B LEVEL control.

f. Set:

HORIZ MODE	A
A COUPLING	LF REJ and HF REJ

g. CHECK—Stable display can be obtained by adjusting the A LEVEL control.

h. Replace the X2 BNC attenuator.

i. CHECK—Stable display can be obtained by adjusting the A LEVEL control in the following A COUPLING switch positions:

AC, DC

j. Remove the X10 BNC attenuator and set the A SOURCE switch to EXT \div 10.

k. CHECK—Stable display can be obtained by adjusting the A LEVEL control in the following A COUPLING switch positions:

AC, DC

l. Remove the X2 BNC attenuator and set the A COUPLING switch to LF REJ then HF REJ.

m. CHECK—Stable display can be obtained by adjusting the A LEVEL control.

3. Check A Normal Mode

a. Set:

A COUPLING	AC
A SOURCE	NORM
TRIG MODE	AUTO

b. Adjust A LEVEL for a stable display.

c. Set the TRIG MODE switch to NORM.

d. CHECK—Stable display is visible.

e. Set the CH 1 AC-GND-DC switch to GND.

f. CHECK—No visible display in the absence of an adequate trigger signal.

4. Check Single Sweep

a. Set the CH 1 AC-GND-DC switch to DC.

b. Adjust A LEVEL until the display just triggers.

c. Set the CH 1 AC-GND-DC switch to GND.

d. Push the SINGL SWP button.

e. CHECK—READY light comes on and stays on.

f. Set the CH 1 AC-GND-DC switch to DC.

g. CHECK—READY light goes out and a single sweep occurs.

h. Push the SINGL SWP button.

i. CHECK—Single sweep occurs every time the SINGL SWP button is pushed.

j. Disconnect the test setup.

Performance Check—465 Service (SN B250000 & up)

5. Check Trigger View

a. Set:

A TIME/DIV	0.2 ms
A COUPLING	DC
A SOURCE	EXT

b. Connect a 200 millivolt standard amplitude signal from the calibration generator to the A EXT input.

c. Push the TRIG VIEW button and hold it in.

d. CHECK—Display amplitude is 3.2 to 4.8 divisions.

e. Disconnect the test setup.

Performance Check—465 Service (SN B250000 & up)

IMPORTANT NOTE

OSCILLOSCOPES WITH DIGITAL MULTIMETERS ATTACHED, REFER TO THE DIGITAL MULTIMETER MANUAL AT THIS POINT, THEN RETURN TO STEP 8 IN THE HORIZONTAL SECTION.

OSCILLOSCOPES WITHOUT DIGITAL MULTIMETERS, CONTINUE WITH THIS PROCEDURE.

HORIZONTAL

Equipment Required	
1. Time-Mark Generator	3. Leveled Sine-Wave Generator
2. Calibration Generator	4. 42 Inch, 50 ohm BNC Cable
	5. 50 ohm BNC Termination

465 Control Settings

POWER ON

CRT

INTENSITY As desired
 FOCUS Best focused display
 SCALE ILLUM As desired

VERTICAL (CH 1 and CH 2)

VERT MODE CH 1
 POSITION Midrange
 VOLTS/DIV 0.5 V
 VAR VOLTS/DIV Calibrated detent
 AC-GND-DC DC
 INVERT Normal (button out)
 20 MHz BW (PULL) Full bandwidth (No yellow showing)

TRIGGER (A and B)

COUPLING AC
 LEVEL Midrange
 SLOPE +
 A SOURCE NORM
 B SOURCE STARTS AFTER DELAY
 TRIG MODE AUTO
 A TRIG HOLDOFF NORM

SWEEP (A and B)

HORIZ DISPLAY A
 TIME/DIV 1 ms
 VAR TIME/DIV Calibrated detent
 DELAY TIME POSITION Fully counterclockwise
 X10 MAG Off (button out)
 POSITION (horizontal) Midrange
 FINE Midrange

1. Check A and B Timing Accuracy

a. Connect the time-mark generator to CH 1 via a 50 ohm BNC cable and a 50 ohm BNC termination.

b. CHECK—A and B timing accuracy according to Table 5-3. Timing to be accurate within 3% (0.3 division at the 11th time marker). If 11 time markers are not visible when checking B sweep, set the A TIME/DIV switch one step slower than the B TIME/DIV switch.

i.e.

A TIME/DIV 1 ms
 B TIME/DIV 0.5 ms

**TABLE 5-3
 A AND B TIMING ACCURACY**

A and B TIME/DIV Switch Setting	Time-Mark Generator Output	CRT Display (Markers/Division)
0.05 μ s	50 ns	1
.1 μ s	0.1 μ s	1
.2 μ s	0.1 μ s	2
.5 μ s	0.5 μ s	1
1 μ s	1 μ s	1
2 μ s	1 μ s	2
5 μ s	5 μ s	1
10 μ s	10 μ s	1
20 μ s	10 μ s	2
50 μ s	50 μ s	1
.1 ms	0.1 ms	1
.2 ms	0.1 ms	2
.5 ms	0.5 ms	1
1 ms	1 ms	1
2 ms	1 ms	2
5 ms	5 ms	1
*10 ms	10 ms	1
*20 ms	10 ms	2
*50 ms	50 ms	1

TABLE 5-3 (cont)

A and B TIME/DIV Switch Setting	Time-Mark Generator Output	CRT Display (Markers/Division)
A SWEEP ONLY		
*.1 s	0.1 s	1
*.2 s	0.1 s	2
*.5 s	0.5 s	1

*Set the TRIG MODE switch to NORM

2. Check A Variable Time/Division Range

a. Set:

HORIZ MODE A
 TRIG MODE AUTO
 TIME/DIV 2 ms

b. Select 5 millisecond time marks from the time mark generator.

c. CHECK—At least 1 marker per division can be obtained by adjusting the VAR TIME/DIV control.

d. Return the VAR TIME/DIV control to the detent position.

3. Check Delay or Differential Time Linearity

a. Set:

A TIME/DIV 1 ms
 B TIME/DIV 5 μ s
 HORIZ DISPLAY B DLY'D

b. Set the time mark generator for 1 millisecond time marks.

c. Set the DELAY TIME POSITION dial to position the tenth time marker to the beginning of the trace (about 10.00).

d. Note the reading on the DELAY TIME POSITION dial.

e. Adjust the DELAY TIME POSITION dial so that the ninth time marker is at the beginning of the trace.

f. CHECK—DELAY TIME POSITION dial for a reading one division less, within 0.01 division from +15°C to +35°C; (one division less, within 0.03 division from -15°C to +55°C) than the reading noted in step d.

g. Rotate the DELAY TIME POSITION dial to position each successive time marker to the beginning of the sweep.

h. CHECK—DELAY TIME POSITION dial for a reading of one division less, within 0.01 division from +15°C to +35°C (one division less, within 0.03 division from -15°C to +55°C) than the adjacent time marker.

4. Check Delay or Differential Time Accuracy

a. Set:

B SOURCE STARTS AFTER DELAY
 A TIME/DIV 0.2 μ s
 B TIME/DIV 0.05 μ s

b. Set the A TIME/DIV, B TIME/DIV and the time mark generator to the settings given in Table 5-4. First set the DELAY TIME POSITION dial to 1.00. Adjust the horizontal

TABLE 5-4
 DELAY OR DIFFERENTIAL TIME ACCURACY

A TIME/DIV Switch Setting	B TIME/DIV Switch Setting	Time-Mark Generator Output
.2 μ s	0.5 μ s	.1 μ s
.5 μ s	0.5 μ s	.5 μ s
1 μ s	.1 μ s	1 μ s
2 μ s	.1 μ s	1 μ s
5 μ s	.5 μ s	5 μ s
10 μ s	1 μ s	10 μ s
20 μ s	1 μ s	10 μ s
50 μ s	5 μ s	50 μ s
.1 ms	10 μ s	.1 ms
.2 ms	10 μ s	.1 ms
.5 ms	50 μ s	.5 ms
1 ms	.1 ms	1 ms
2 ms	.1 ms	1 ms
5 ms	.5 ms	5 ms
*10 ms	1 ms	10 ms
*20 ms	1 ms	10 ms
*50 ms	5 ms	50 ms
*.1 s	10 ms	.1 s
*.2 s	10 ms	.1 s
*.5 s	50 ms	.5 s

*Set the TRIG MODE switch to NORM.

Performance Check—465 Service (SN B250000 & up)

POSITION control so the top of the displayed time mark crosses the center vertical graticule line. (If the top of the time marker at the beginning of the sweep isn't visible, then use the time mark near the end of the sweep). Without touching the horizontal POSITION control, set the DELAY TIME POSITION dial to 9.00. Slightly readjust the DELAY TIME POSITION dial to position the top of the displayed time mark to the center vertical graticule line.

CHECK—DELAY TIME POSITION dial setting to be 8.92 to 9.08.

Repeat the above for each of the settings listed in Table 5-4.

5. Check Delay or Differential Jitter

a. Set:

DELAY TIME POSITION	9.00
HORIZ DISPLAY	B DLY'D
A TIME/DIV	1 ms
B TIME/DIV	0.2 μ s
B SOURCE	STARTS AFTER DELAY

b. Select 1 ms time marks.

c. Slightly readjust the DELAY TIME POSITION dial to position the time mark to the center of the graticule.

d. CHECK—Jitter on the leading edge of the time marker does not exceed 1 division (2.5 divisions if operating from a 50 hertz line voltage). Disregard the slow drift.

e. Set the DELAY TIME POSITION dial to 1.00 and repeat step d.

6. Check Mixed Sweep Accuracy

a. Set:

A TIME/DIV	1 ms
B TIME/DIV	.5 ms
DELAY TIME POSITION	Fully clockwise

b. Select 1 ms time marks.

c. CHECK—Timing error between the second and the tenth time marks.

Note the amount of error for step e.

d. Set the HORIZ DISPLAY switch to MIX.

e. CHECK—Timing between the second and tenth time marks is within 0.18 division \pm the error noted in step c.

f. Disconnect the time mark generator.

7. Check A Intensified and B Ends A

a. Set:

A TIME/DIV	1 ms
B TIME/DIV	.1 ms
DELAY TIME POSITION	About 5.00
HORIZ DISPLAY	A INTEN

b. CHECK—B portion of the trace is intensified (about 1 division).

c. Rotate A TRIG HOLDOFF control clockwise to the B ENDS A position (in the detent).

d. CHECK—Trace ends at the end of the intensified portion.

8. Check X Gain

a. Set:

TIME/DIV (both)	X-Y
VERT MODE	CH 2
VOLTS/DIV (both)	5 mV
CH 1 AC-GND-DC	AC
CH 2 AC-GND-DC	GND
HORIZ DISPLAY	A
A TRIG HOLDOFF	Fully counterclockwise

b. Connect a 20 millivolt standard amplitude signal from the calibration generator to the CH 1 input via a 50 ohm BNC cable.

c. CHECK—Display is 4 divisions (± 0.16 division) between the dots.

d. Set CH 1 AC-GND-DC switch to DC.

e. CHECK—Display is 4 divisions (± 0.16 division) between the dots. It is normal for this CHECK to be slightly shorter than that in step c.

f. Set the calibration generator for a 50 millivolt standard amplitude signal.

g. CHECK—Display is 10 divisions (± 0.4 division) between the dots.

h. Set the CH 1 AC-GND-DC switch to AC.

i. CHECK—Display is 10 divisions (± 0.4 division) between the dots. It is normal for this CHECK to be slightly longer than step g.

j. Disconnect the test setup.

Performance Check—465 Service (SN B250000 & up)

9. Check X Bandwidth

a. Connect the leveled sine-wave generator to the CH 1 input via a 50 ohm BNC cable and 50 ohm BNC termination.

b. Adjust the generator for a 10 division display of a 50 kilohertz reference signal.

c. Without touching the generator amplitude, adjust the generator frequency to 4 megahertz.

d. CHECK—Display is at least 7 divisions in length.

e. Disconnect the test setup.

CALIBRATION

IMPORTANT—PLEASE READ BEFORE USING THIS PROCEDURE

Purpose

The purpose of the calibration procedure is to provide a calibration sequence for adjustments—not to provide a trouble-shooting guide. See the Trouble Shooting Aids portion of the Maintenance Section for trouble-shooting information.

Limits and Tolerances

All limits and tolerances given in this procedure are calibration guides and should not be interpreted as instrument specifications unless they are also found in the Specifications section of this manual.

Tolerances given are for the instrument under test and do not include test equipment error.

Step Titles

Where possible, instrument performance is checked before an adjustment is made. Steps containing checks and adjustments are titled Check/Adjust. Those with checks only are titled Check.

Line Voltage Selection

This procedure is for 115 volt ac line, medium range. If a different range is to be used, set the Regulating Range Selector and Line Voltage Selector for the available line voltage (see item 42 under Controls and Connectors in Section 2).

Internal Adjustments

Do not preset the internal controls or move the +55 volt supply adjustment as this will typically require complete recalibration of the oscilloscope.

Display

The most accurate display adjustments are made with a stable, well-focused, low-intensity display. Unless otherwise noted, adjust the Intensity, Astigmatism, Focus, and Trigger Level controls as needed.

Test Equipment Required

The test equipment listed in Table 6-2, or equivalent, is required for complete calibration of the oscilloscope.

Specifications given for the equipment are the minimum necessary for accurate calibration. Therefore, the equipment used must meet or exceed the listed specifications. Detailed operating instructions for the test equipment are not given in this procedure. Refer to the appropriate instruction manual if more information is needed.

Special Calibration Fixtures. Special calibration fixtures are used only where they facilitate instrument calibration. These fixtures are available from Tektronix Inc. Order by part number through your local Tektronix Field Office or Representative.

Calibration Equipment Alternatives and Partial Procedures. The Calibration procedure is based on the first item of equipment given as an example. When other equipment is substituted, control settings or calibration setups might need to be altered. If the exact equipment listed is not available, check the specifications column carefully to see if any other equipment might suffice. Then check the usage column to see what this item is used for. If used for a check that is of little or no importance to your measurement requirements, the item and corresponding step(s) can be deleted.

If the applications for which you will use the 465 do not require the full performance available, the procedure and the equipment list can be shortened accordingly. For example, the basic measurement capabilities of this instrument can be verified by checking and adjusting as needed: vertical deflection factor, horizontal timing accuracy, and the calibrator signal. If any step requires more than a minor readjustment, check Table 6-1 for any possible interactions.

Interactions

Table 6-1 shows calibration adjustments and the possible interaction each adjustment might have on other adjustments. The use of Table 6-1 is particularly important if only a partial procedure is performed or if a circuit requires recalibration due to component replacement.

To use this table, find the adjustment made in the column at the left of the table. Then move to the right across that row until you come to a darkened square. From the darkened square move up the column and check the accuracy of the adjustment titling that column. Readjust if necessary.

**TABLE 6-1
ADJUSTMENT INTERACTIONS**

Adjustment made	H.V. SUPPLY	TRACE ROTATION	Y-AXIS ALIGNMENT	GEOMETRY	STEP ATTENUATOR BALANCE	CH 1 VARIABLE BALANCE	CH 2 VARIABLE BALANCE	INVERT BALANCE	VERT OUT POSITION CENTERING	CH 1 POSITION CENTERING	CH 1 GAIN	CH 2 GAIN	VERT OUT GAIN	SWP START AND A SWP CAL	X1 HORIZONTAL GAIN	X10 HORIZONTAL GAIN	B SWP CAL	0.5 μ TIMING (A AND B)	HIGH SPEED MAG TIMING	TRIGGER SENSITIVITY (A AND B)	SLOPE CENTERING (A AND B)	TRIGGER LEVEL CENTERING (A AND B)	NORMAL DC BALANCE	CH 1 DC BALANCE	CH 2 DC BALANCE	TRIGGER VIEW CENTERING	X GAIN	CRT GRID BIAS	CRT
H. V. SUPPLY																													
TRACE ROTATION																													
Y-AXIS ALIGNMENT																													
GEOMETRY																													
STEP ATTENUATOR BALANCE																													
CH 1 VARIABLE BALANCE																													
CH 2 VARIABLE BALANCE																													
INVERT BALANCE																													
VERT OUT POSITION CENTERING																													
CH 1 POSITION CENTERING																													
CH 1 GAIN																													
CH 2 GAIN																													
VERT OUT GAIN																													
SWP START AND A SWP CAL																													
X1 HORIZONTAL GAIN																													
X10 HORIZONTAL GAIN																													
B SWP CAL																													
0.5 μ TIMING (A AND B)																													
HIGH SPEED MAG TIMING																													
TRIGGER SENSITIVITY (A AND B)																													
SLOPE CENTERING (A AND B)																													
TRIGGER LEVEL CENTERING (A AND B)																													
NORMAL DC BALANCE																													
CH 1 DC BALANCE																													
CH 2 DC BALANCE																													
TRIGGER VIEW CENTERING																													
X GAIN																													
CRT GRID BIAS																													
CRT																													

NOTE

For 465's with the IC version of the Vertical Output Amplifier, adjusting the Vertical Output bias affects Vertical Output Gain and High Frequency compensation.

TABLE 6-2
TEST EQUIPMENT REQUIRED

Description	Minimum Specifications	Usage	Examples
1. Variable Autotransformer	Capable of Supplying 1.2 amperes over a range of 103.5 to 126.5 volts.	Power supply regulation check.	General Radio W8MT3VM Variac Autotransformer
2. Digital Voltmeter ¹	Range, 0 to 140 volts; dc voltage accuracy, within 0.15%; display, 4 1/2 digits.	Low-Voltage Power Supply checks and adjustments. CRT Grid Bias adjustment. Vertical and Horizontal Centering adjustments. Calibrator Output Voltage adjustment.	a. Tektronix DM 501 Digital Multimeter. ¹ b. Any digital voltmeter that meets minimum specifications.
3. DC Voltmeter	Range, 0 to 2500 volts; calibrated to 1% accuracy at -2450 volts.	High-Voltage Power Supply adjustment.	a. Triplett Model 630-NA. b. Simpson Model 262.
4. Test Oscilloscope with 10X probe and 1X probe.	Bandwidth, DC to 100 megahertz; minimum deflection factor, 5 mV/division; accuracy, within 3%; dual trace.	Power Supply Ripple Check. CRT Z-Axis Compensation; Vertical gain adjustment. A Trigger Holdoff check. A and B + Gate Output Signals check.	a. Tektronix 465 Oscilloscope with 2 P6065A (10X) probes. b. Tektronix 475 Oscilloscope with 2 P6075 (10X) probes.
5. Amplitude Calibrator	Amplitude accuracy, within 0.25%; signal amplitude, 2 millivolts to 50 volts; output signal, 1 kilohertz square wave.	Vertical checks and adjustments. Trigger View Gain check. X Gain adjustment. External Z-Axis check	a. Tektronix PG 506 Calibration Generator. ¹ b. Tektronix 067-0502-01 calibration fixture.
6. Sine-wave Generator	Frequency, 350 kilohertz to above 100 megahertz; output amplitude, variable from 0.5 to 4 volts peak-to-peak; output impedance, 50 ohms; reference frequency, 50 to 350 kilohertz; amplitude accuracy, constant within 3% of reference frequency as output frequency changes.	Vertical Centering. Bandwidth and Isolation checks. Trigger checks and adjustments. X-Y Phase Difference. X Bandwidth check.	a. Tektronix SG 503 Leveled Sine-wave Generator. ¹ b. Tektronix Type 191 Constant-Amplitude Signal Generator.
7. Time-Mark Generator	Marker outputs, 2 nanoseconds to 0.5 second; marker accuracy, within 0.1%; trigger output, 1 millisecond to 0.1 microsecond, time coincident with markers.	CRT Y-Axis and geometry adjustments. Auto Trigger check. Horizontal timing checks and adjustments.	a. Tektronix TG 501 Time-Mark Generator. ¹ b. Tektronix 2901 Time-Mark Generator.

¹Requires a TM 500 series power module.

TABLE 6-2 (cont)

Description	Minimum Specifications	Usage	Examples
8. Low-Frequency Generator	Frequency, 10 hertz to 50 kilohertz; output amplitude, variable from 10 millivolts to 4 volts peak-to-peak.	Low-Frequency Trigger checks.	a. Tektronix SG 502 Oscillator. ¹ b. General Radio 1310A Oscillator.
9. Square-Wave Generator	Repetition rate, 1 to 100 kilohertz; risetime, 1 nanosecond or less from fast-rise output; output amplitude, 60 volt pulse supplying at least 10 milliamperes from high-amplitude output; aberrations, within 2% from fast-rise output.	Vertical Compensation.	a. Tektronix PG 506 Calibration Generator ¹ . b. Tektronix Type 106 Square-Wave Generator.
10. 50-Ohm Signal Pickoff	Frequency response, 50 kilohertz to 100 megahertz; impedance 50 ohms for signal input, signal output and trigger output.	Trigger checks and adjustments.	Tektronix CT-3 Signal Pick-off. Part Number 017-0061-00.
11. Cable (2 Required)	Impedance, 50 ohms; Length, 42 inches; Connectors, BNC	Signal interconnection.	Tektronix Part Number 012-0057-01.
12. Cable (2 Required)	Impedance, 50 ohms; Length, 18 inches; Connectors, BNC	Signal interconnection.	Tektronix Part Number 012-0076-00.
13. Adapter	Connectors, GR874 to BNC female	Vertical Compensation; Trigger adjustments.	Tektronix Part Number 017-0063-00.
14. Adapter	Connectors, BNC female to BNC female.	Signal interconnection.	Tektronix Part Number 103-0028-00.
15. Dual-Input Coupler (2 required)	Connectors, BNC female to 2 BNC male.	Vertical checks. Trigger checks and adjustments. X-Y Phase check.	Tektronix Part Number 067-0525-00.
16. T Connector	Connectors, BNC	Signal interconnection.	Tektronix Part Number 103-0030-00.
17. 10X Attenuator (2 required)	Ratio, 10X; impedance, 50 ohms; connectors, BNC	Vertical Compensation. Vertical Bandwidth check. Trigger adjustments.	Tektronix Part Number 011-0059-01.
18. 5X Attenuator	Ratio, 5X; impedance, 50 ohms; connectors, BNC	Vertical System Compensation adjustments. Trigger adjustments.	Tektronix Part Number 011-0060-01.
19. 2X Attenuator	Ratio, 2X; impedance, 50 ohms; connectors, BNC.	Vertical System Compensation. Trigger adjustments.	Tektronix Part Number 011-0069-01.

¹Requires a TM 500 series power module.

TABLE 6-2 (cont)

Description	Minimum Specifications	Usage	Examples
20. Termination (2 Required)	Impedance, 50 ohms; connectors, BNC	Signal termination.	Tektronix Part Number 011-0049-01.
21. Input RC Normalizer	RC time constant, 1 megohm times 20 picofarads; connectors, BNC.	Vertical Input Attenuator Compensation.	Tektronix input RC Normalizer calibration fixture. Part Number 067-0538-00.
22. Screw-driver	Length, three-inch shaft, bit size, 3/32 inch.	Adjust variable resistors.	Xcelite R-3323.
23. Low-Capacitance Screw-driver	Length, 1-inch shaft; bit size, 3/32 inch.	Adjust all variable capacitors.	J.F.D. Electronics Corp. Adjustment Tool Number 5284.
24. Shorting Strap		Calibrator adjustment.	

INDEX TO CALIBRATION PROCEDURE

Power Supply

- 1. Check/Adjust Power Supply DC Levels, Regulation and Ripple Page 6-8
- 2. Check/Adjust High Voltage Supply 6-9

Display and Z Axis

- 1. Check/Adjust CRT Grid Bias 6-10
- 2. Check/Adjust Trace Alignment 6-10
- 3. Check/Adjust Y-Axis Alignment 6-11
- 4. Check/Adjust Geometry 6-11
- 5. Check/Adjust Z-Axis Compensation 6-11

Vertical

- 1. Check Probe Coding Indicator Lights 6-13
- 2. Check CH 1 and CH 2 Gate Current 6-13
- 3. Check AC-GND-DC Switches 6-13
- 4. Check Alternate Mode 6-13
- 5. Check Chop Mode 6-13
- 6. Adjust Vertical Output Bias 6-14

- 7. Check/Adjust Vertical Output Centering 6-14
- 8. Check/Adjust Ch 1 Step Attenuator Balance 6-14
- 9. Check/Adjust Ch 1 Variable Volts/Div Balance 6-14
- 10. Check/Adjust Ch 2 Step Attenuator Balance 6-15
- 11. Check/Adjust Ch 2 Variable Volts/Div Balance 6-15
- 12. Check/Adjust Ch 2 Invert Balance 6-15
- 13. Check/Adjust Ch 2 Position Centering 6-15
- 14. Check/Adjust Ch 1 Position Centering 6-15
- 15. Check Beam Finder Operation 6-16
- 16. Check/Adjust Ch 1 and Vertical Output Gain 6-16
- 17. Check/Adjust Ch 2 Gain 6-16
- 18. Check Ch 1 and Ch 2 Variable Volts/Division Range 6-16
- 19. Check Add Mode 6-17
- 20. Check Compression and Expansion 6-17
- 21. Check/Adjust Vertical Output Low Frequency Compensation 6-17

Calibration—465 Service (SN B250000 & up)

22. Check/Adjust Ch 1 Volts/Division Compensation	6-18	12. Check A Internal 100 megahertz Triggering	6-30
23. Check/Adjust Ch 2 Volts/Division Compensation	6-18	13. Check B Internal 100 megahertz Triggering	6-30
24. Check/Adjust Ch 2 and Vertical Output High Frequency Compensation	6-19	14. Check A & B High Frequency Reject Triggering	6-31
25. Check Ch 2 Position Effect	6-19	15. Check Single Sweep	6-31
26. Check/Adjust Ch 2 10 millivolt and 20 millivolt High Frequency Compensation	6-20	16. Check 60 Hertz Internal and Low Frequency Reject Triggering	6-31
27. Check/Adjust Ch 1 High Frequency Compensation	6-20	17. Check 60 Hertz External Triggering	6-32
28. Check Ch 1 Position Effect	6-21	18. Check External Trigger Level Ranges	6-33
29. Check/Adjust Ch 1 10 millivolt and 20 millivolt High Frequency Compensation	6-21	19. Check Line Triggers	6-33
30. Check Bandwidth	6-21	20. Check A Normal Mode	6-34
31. Check Cascade Gain and Bandwidth	6-22	21. Check/Adjust Trigger View Centering	6-34
32. Check Channel Isolation	6-22	22. Check Trigger View Gain	6-34
33. Check Common Mode Rejection Ratio	6-22		
34. Check Bandwidth Limit Operation	6-23		
		Horizontal	
Triggers		1. Check/Adjust Sweep Start and A Sweep Calibration	6-35
1. Check/Adjust A Trigger Sensitivity	6-24	2. Check Delay or Differential Time Linearity	6-36
2. Check/Adjust B Trigger Sensitivity	6-25	3. Check/Adjust Horizontal Amplifier Gain	6-36
3. Check/Adjust B Trigger Slope and Level Centering	6-26	4. Check Sweep Linearity	6-37
4. Check/Adjust A Trigger Slope and Level Centering	6-26	5. Check/Adjust Magnifier Registration	6-37
5. Check/Adjust A Trigger DC Levels	6-26	6. Check/Adjust B Sweep Calibration	6-37
6. Check B Trigger DC Levels	6-27	7. Check A Sweep Length	6-37
7. Check B Internal 25 megahertz Triggering	6-27	8. Check Variable Time/Division	6-37
8. Check A Internal 25 megahertz Triggering	6-28	9. Check Horizontal Position Range	6-37
9. Check A External 25 megahertz Triggering	6-28	10. Check/Adjust A 10 μ s Timing	6-38
10. Check B External 25 megahertz Triggering	6-29	11. Check/Adjust A Sweep High Speed Timing	6-38
11. Check B and A External 100 megahertz Triggering	6-29	12. Check/Adjust B Sweep High Speed Timing	6-38
		13. Check A and B Time/Division Accuracy	6-39

Calibration—465 Service (SN B250000 & up)

14. Check/Adjust High Speed Magnified Timing	6-39
15. Check A and B Magnified Timing Accuracy	6-39
16. Check Delay or Differential Timing Accuracy	6-40
17. Check Delay or Differential Time Jitter	6-40
18. Check Mixed Sweep Accuracy	6-40
19. Check/Adjust X Gain	6-41

20. Check X-Y Phasing and Bandwidth	6-41
21. Check B Ends A	6-41
22. Check A Trigger Holdoff	6-41

Gates, Calibrator and Ext Z Axis

1. Check A and B + Gates	6-43
2. Check/Adjust Calibrator DC Level	6-44
3. Check External Z Axis	6-44

POWER SUPPLY

Equipment Required	
1. Digital Voltmeter	3. Test Oscilloscope
2. DC Voltmeter	4. Autotransformer
	5. 3 Inch slotted Screwdriver

See **ADJUSTMENT LOCATIONS 1** in the Diagrams section for adjustments and test points (TP).

465 Control Settings

Power Controls

Regulating Range Selector Medium
 Line Voltage Selector 115 V
 POWER ON

CRT Controls

INTENSITY As desired
 FOCUS Best focused display
 SCALE ILLUM As desired

Vertical Controls

(both Channels if applicable)

VOLTS/DIV 5 mV
 VAR Calibrated detent
 POSITION Midrange
 AC-GND-DC GND
 VERT MODE CH 1
 INVERT Normal (button out)
 20 MHz BW (Pull) Off (No yellow showing)

Triggering Controls

(both A and B if applicable)

LEVEL As needed for a stable display
 SLOPE +
 COUPLING AC
 SOURCE NORM
 TRIG MODE AUTO

Sweep Controls

HORIZ DISPLAY A
 DELAY TIME POSITION Fully counterclockwise
 A TIME/DIV 1 ms
 B TIME/DIV 1 ms
 VAR TIME/DIV Calibrated detent
 X10 MAG Off (button out)
 POSITION Midrange
 FINE Midrange
 A TRIG HOLDOFF NORM

1. Check/Adjust Power Supply DC Levels, Regulation and Ripple

NOTE

Review the information at the beginning of the Calibration Section before starting Calibration.

a. Connect the digital voltmeter between the test point given in Table 6-3 and ground. Voltage to be within the given limits.

TABLE 6-3

LOW VOLTAGE POWER SUPPLY LIMITS

Power Supply	Test Point	Reading	Tolerance
+55 V	TP1536	+54.72 to +55.27	±0.5%
+15 V	TP1548	+14.77 to +15.22	±1.5%
+5 V	TP1558	+4.92 to +5.07	±1.5%
-8 V	TP1568	-8.12 to -7.880	±1.5%
+110 V	TP1518	+107.8 to +113.4	+3%; -2%

NOTE

If the adjustment in step 1b is made, the oscilloscope will require complete recalibration.

b. Connect the digital voltmeter to TP1536: ADJUST +55 volt supply (R1538) for +55 volts. Recheck all supplies according to Table 6-3.

c. Connect the test oscilloscope to the indicated test point and check the ripple amplitude according to Table 6-4 while varying the line voltage between 103.5 volts and 126.5 volts.

**TABLE 6-4
TYPICAL LOW VOLTAGE
POWER SUPPLY RIPPLE**

Power Supply	Test Point	Typical Ripple (Peak-to-Peak)
+55 V	TP1536	4 mV
+15 V	TP1548	2 mV
+5 V	TP1558	2 mV
-8 V	TP1568	2 mV
+110 V	TP1518	20 mV

d. Return line voltage to 115 volts.

2. Check/Adjust High Voltage Supply

a. Connect the dc voltmeter between TP1423 and ground on the interface board (TP1423 is accessible through a hole in the high voltage cover).

b. CHECK—High Voltage supply for -2450 volts $\pm 2\%$ (-2401 volts to -2499 volts).

c. ADJUST—High Voltage (R1400) for -2450 volts.

d. Disconnect the dc voltmeter from the 465.

DISPLAY AND Z AXIS

Equipment Required	
1. DC Voltmeter	5. 50-ohm BNC Termination
2. Test Oscilloscope	6. X10 Probe
3. Time Mark Generator	7. 3 Inch slotted Screwdriver
4. 50-ohm BNC Cable	8. Low Capacitance slotted Screwdriver

See **ADJUSTMENT LOCATIONS 1** in the Diagrams section for adjustments and test points (TP).

465 Control Settings (*Indicates Changes From the Previous Step)

Power Controls

Regulating Range Selector	Medium
Line Voltage Selector	115 V
POWER	ON

CRT Controls

INTENSITY	As desired
FOCUS	Best focused display
*SCALE ILLUM	*Fully counterclockwise

Vertical Controls (both Channels if applicable)

VOLTS/DIV	5 mV
VAR	Calibrated detent
POSITION	Midrange
AC-GND-DC	GND
VERT MODE	CH 1
INVERT	Normal (button out)
20 MHz BW (Pull)	Off (No yellow showing)

Triggering Controls (both A and B if applicable)

LEVEL	As needed for a stable display
SLOPE	+
COUPLING	AC
SOURCE	NORM
TRIG MODE	AUTO

Sweep Controls

HORIZ DISPLAY	A
DELAY TIME POSITION	Fully counterclockwise
*A TIME/DIV	*X-Y
*B TIME/DIV	*X-Y
VAR TIME/DIV	Calibrated detent
X10 MAG	Off (button out)
POSITION	Midrange
FINE	Midrange
A TRIG HOLDOFF	NORM

1. Check/Adjust CRT Grid Bias

a. Connect the digital voltmeter between TP1486 and ground. (TP1486 is accessible through a hole in the high voltage cover.)

b. Set the INTENSITY control for +20 volts on the digital voltmeter.

c. CHECK—Display for a well defined, low intensity dot. Use FOCUS and ASTIG controls as needed.

d. ADJUST—Grid Bias (R1480) for a visible dot, then back until the dot just disappears.

2. Check/Adjust Trace Alignment

a. Set:

A TIME/DIV	0.5 ms
INTENSITY	as desired
SCALE ILLUM	as desired

b. Position the trace to the center horizontal graticule line.

c. CHECK—Trace is parallel with the center horizontal graticule line.

d. ADJUST—TRACE ROTATION (front panel adjustment) to make the trace parallel with the center horizontal graticule line.

3. Check/Adjust Y-Axis Alignment

a. Connect 1 ms time marks from the time-mark generator to the CH 1 input via a 50 ohm BNC cable and a 50 ohm BNC termination.

b. Set:

CH 1 AC-GND-DC	DC
CH 1 VOLTS/DIV	0.1 V

c. Adjust VAR TIME/DIV control for exactly 1 time mark/major division. (Time marks should fill the screen vertically. If not, reduce the VOLTS/DIV switch setting.)

d. CHECK—Display for 0.1 division tilt or less, when compared to the center vertical graticule line.

e. ADJUST—Y-Axis Alignment (R1446) to align the center time mark with the center vertical graticule line.

f. INTERACTION—TRACE ROTATION.

4. Check/Adjust Geometry

a. CHECK—Display for 0.1 division or less, vertical curvature of the markers across the graticule area. (Readjust A VAR TIME/DIV as needed to maintain exactly 1 mark per division.)

b. ADJUST—Geometry (R1442) for minimum curvature of the markers across the graticule area.

c. INTERACTION—Y-Axis Alignment.

d. Disconnect the test setup.

e. Return A VAR TIME/DIV to detent.

5. Check/Adjust Z-Axis Compensation

a. Set the A TIME/DIV switch to 0.05 μ s.

b. Connect the X10 probe from the test oscilloscope to TP1486.

c. Adjust the 465 INTENSITY control for a 15 volt display on the test oscilloscope.

d. CHECK—Test oscilloscope display for optimum square corner on the unblanking gate (with minimum ringing).

e. ADJUST—Z-Axis Compensation (C1471) with a low capacitance screwdriver for the best square corner on the unblanking pulse viewed on the test oscilloscope.

f. Disconnect the test setup.

g. CHECK—Display for uniform intensity across the graticule area (especially the first 2 divisions of the trace).

h. READJUST—C1471, if necessary.

VERTICAL

Equipment Required

- | | |
|---|---|
| <ol style="list-style-type: none"> 1. Calibration Generator 2. Test Oscilloscope 3. Square-wave Generator 4. Leveled Sine-Wave Generator 5. 2 X10 Probes 6. X10 Probe with Scale-Factor Switching (or an 11 kilohm resistor, see Step 1a) | <ol style="list-style-type: none"> 7. 50 ohm BNC Cable 8. Dual-Input Coupler 9. GR to BNC Female Adapter 10. X10 BNC Attenuator (2 required) 11. 50 ohm BNC Termination (2 required) 12. 20 picofarad BNC Normalizer 13. Low-Capacitance Screwdriver 14. 3 Inch slotted Screwdriver |
|---|---|

See **ADJUSTMENT LOCATIONS 2** and **ADJUSTMENT LOCATIONS 3a** or **ADJUSTMENT LOCATIONS 3b** in the Diagrams section for adjustments and test points (TP).

Some instruments have an output stage (and output circuit board) using an integrated circuit (IC). Other instruments contain individual transistors in the output stage (discrete). The pull-out pages ADJUSTMENT LOCATIONS 3a & 3b permit easy identification of the board in your instrument. The calibration procedure indicates the IC output stage adjustments by double boxes.

*POSITION	*Midrange
AC-GND-DC	DC
VERT MODE	CH 1
INVERT	Off (button out)
20 MHz BW (Pull)	Off (No yellow showing)

465 Control Settings (*Indicates Changes From Previous Step)

Power Controls

Regulating Range Selector	Medium
Line Voltage Selector	115 V
POWER	ON

CRT Controls

INTENSITY	As desired
FOCUS	Best focused display
SCALE ILLUM	As desired

Vertical Controls (both Channels if applicable)

*VOLTS/DIV	*5 mV
VAR	Calibrated detent

Triggering Controls (both A and B if applicable)

LEVEL	As needed for a stable display
SLOPE	+
COUPLING	AC
SOURCE	NORM
TRIG MODE	AUTO

Sweep Controls

HORIZ DISPLAY	A
DELAY TIME POSITION	Fully counterclockwise
*A TIME/DIV	*1 ms
*B TIME/DIV	*1 ms
VAR TIME/DIV	Calibrated detent
X10 MAG	Off (button out)
POSITION	Midrange
FINE	Midrange
A TRIG HOLDOFF	NORM

1. Check Probe Coding Indicator Lights

- a. Connect a X10 Probe with a scale-factor switching connector to the CH 1 input connector (or connect an 11 kilohm resistor between the input coding ring and ground).
- b. CHECK—Light under 5 mV position is extinguished and the light under 50 mV position comes on.
- c. Set the VERT MODE switch to CH 2.
- d. Move the probe, or the 11 kilohm resistor, to the CH 2 input.
- e. CHECK—Light under 5 mV position is extinguished and the light under 50 mV position comes on.
- f. Remove the X10 probe or the resistor.

2. Check Ch 1 and Ch 2 Gate Current

a. Set:

CH 1 & CH 2 AC-GND-DC	GND
CH 1 & CH 2 VOLTS/DIV	5 mV

- b. Position the trace to graticule center.
- c. Switch the CH 2 AC-GND-DC switch to DC.
- d. CHECK—Trace shift is 0.1 division or less when CH 2 AC-GND-DC switch is switched between GND and DC.
- e. Set the VERT MODE switch to CH 1.
- f. Position the trace to graticule center.
- g. Switch the CH 1 AC-GND-DC switch to DC.
- h. CHECK—Trace shift is 0.1 division or less when the CH 1 AC-GND-DC switch is switched between GND and DC.

3. Check AC-GND-DC Switches

- a. Connect a 20 millivolt standard amplitude signal from the calibration generator to the CH 1 input via a 50 ohm BNC cable (unterminated).

- b. Position the bottom of the display to the center horizontal graticule line.
- c. Set the CH 1 AC-GND-DC switch to GND.
- d. CHECK—For no vertical deflection; trace is on the center horizontal graticule line.
- e. Set the CH 1 AC-GND-DC switch to AC.
- f. CHECK—Display is centered about the center horizontal graticule line.
- g. Move the test signal to CH 2.
- h. Set the VERT MODE switch to CH 2.
- i. Position the bottom of the display to the center horizontal graticule line.
- j. Set CH 2 INPUT COUPLING switch to GND.
- k. CHECK—Display for no vertical deflection; trace is at the center horizontal graticule line.
- l. Set the CH 2 INPUT COUPLING switch to AC.
- m. CHECK—Display is centered about the center horizontal graticule line.
- n. Remove the test setup.

4. Check Alternate Mode

a. Set:

VERT MODE	ALT
A TRIGGER LEVEL	Fully counterclockwise

- b. Position the 2 traces about 2 divisions apart.
- c. CHECK—Sweeps alternate at all settings of the A TIME/DIV switch except X-Y.

5. Check Chop Mode

a. Set:

A TIME/DIV	1 μ s
VERT MODE	CHOP
AC-GND-DC (Both)	GND

Calibration—465 Service (SN B250000 & up)

- b. Position the 2 traces about 4 divisions apart.
- c. Adjust the A LEVEL control for a stable display.
- d. CHECK—Display for blanking of switching transients between chopped segments.
- e. CHECK—Duration of each cycle is about 4 divisions.

6. Adjust Output Amplifier Bias (IC version only)

NOTE

This adjustment affects position effect, aberrations, and risetime. This adjustment may be slightly misadjusted for optimum vertical performance. Severe misadjustment will result in loss of gain and increased aberrations.

If performing a routine recalibration, do not adjust at this time. Move to step 7 and complete the checks in Steps 7 through 25. If calibration requirements are met there is no need to readjust the bias. If position effect, aberrations and risetime requirements are met, then readjust the bias according to the procedure in the note after step 25.

Recalibration Due to Replacement of Vertical Output IC.

ADJUST As follows:

- a. Set:

VERT MODE	CH 1
CH 1 VOLTS/DIV	0.2 V
CH 1 AC-GND-DC	DC
- b. Connect the leveled-sine wave generator to the CH 1 input via a 50 ohm BNC cable and 50 ohm BNC termination.
- c. Adjust the leveled sine-wave generator for a few divisions of display.
- d. ADJUST—Vertical Output Bias (R455) for maximum display amplitude.
- e. Disconnect the test setup.

7. Check/Adjust Vertical Output Centering and Beam Finder

- a. Set:

VERT MODE	CH 1
CH 1 & CH 2 VOLTS/DIV	5 mV
CH 1 & CH 2 AC-GND-DC	GND
- b. Connect the dc voltmeter between TP322 and TP324.
- c. Adjust the CH 1 POSITION control for 0 volt on the voltmeter.
- d. ADJUST—Vertical Output Centering (R429) (R4418) to position the trace to the center graticule line.
- e. Remove the voltmeter lead connections.

8. Check/Adjust Ch 1 Step Attenuator Balance

- a. Set the CH 1 VOLTS/DIV switch to 20 mV.
- b. Position the trace to the center horizontal graticule line.
- c. CHECK—Display for 0.2 division or less of trace shift between adjacent positions when rotating the CH 1 VOLTS/DIV switch from 20 mV to 5 mV.
- d. ADJUST—CH 1 Step Atten Bal (R25) for minimum trace shift when rotating the CH 1 VOLTS/DIV switch from 20 mV to 5 mV.

9. Check/Adjust Ch 1 Variable Volts/Division Balance

- a. Position the trace to the center horizontal graticule line.
- b. CHECK—Display for 1.0 division or less of trace shift when rotating the CH 1 VAR control through its range.
- c. CHECK—CH 1 UNCAL light comes on when the VAR control is out of the detent position.
- d. ADJUST—CH 1 Variable Balance (R120) for minimum trace shift when rotating the CH 1 VAR control through its range.

e. Return the CH 1 VAR control to the detent position.

10. Check/Adjust Ch 2 Step Attenuator Balance

a. Set:

VERT MODE	CH 2
CH 2 VOLTS/DIV	20 mV

b. Position the trace to the center horizontal graticule line.

c. CHECK—Display for 0.2 division or less of trace shift between adjacent switch positions when rotating the CH 2 VOLTS/DIV switch from 20 mV to 5 mV.

d. ADJUST—CH 2 Step Atten Bal (R75) for minimum trace shift when rotating the CH 2 VOLTS/DIV switch from 20 mV to 5 mV.

11. Check/Adjust Ch 2 Variable Volts/Division Balance

a. CHECK—Display for 1.0 division or less of trace shift when rotating the CH 2 VAR control through its range.

b. CHECK—CH 2 UNCAL light comes on when the CH 2 VAR control is out of the detent position.

c. ADJUST—CH 2 Variable Balance (R220) for minimum trace shift when rotating the CH 2 VAR control through its range.

d. Return the VAR control to the detent position.

12. Check/Adjust Ch 2 Invert Balance

a. Position the trace to the center horizontal graticule line.

b. Push the INVERT button.

c. CHECK—2 divisions or less of trace shift between INVERT in and INVERT out.

d. ADJUST—Invert Balance (R215) for minimum trace shift between INVERT in and INVERT out.

e. INTERACTION—CH 2 Variable Volts/Division balance.

13. Check/Adjust CH 2 Position Centering

a. Connect the leveled sine-wave generator to the Ch 2 input via a 50 ohm BNC cable and a 50 ohm BNC termination.

b. Set:

CH 2 INVERT	Button out
CH 2 VOLTS/DIV	0.1 V
CH 2 AC-GND-DC	DC
A TIME/DIV	1 ms
INTENSITY	as needed for a visible display

c. Adjust the leveled sine-wave generator for 4.8 divisions of a 50 kilohertz signal.

d. Set the CH 2 VOLTS/DIV switch to 20 mV (24 divisions of display).

e. CHECK—Display can be positioned both above and below the center horizontal graticule line.

f. ADJUST—Slight readjustment of vertical output centering **R429** (R4418) can be made such that the display can be positioned an equal distance both above and below the center horizontal graticule line.

14. Check/Adjust CH 1 Position Centering

a. Move the leveled sine-wave generator signal to the CH 1 input.

b. Set:

CH 1 AC-GND-DC	DC
CH 1 VOLTS/DIV	20 mV
VERT MODE	CH 1

c. CHECK—Display can be positioned both above and below the center horizontal graticule line.

d. ADJUST—CH 1 Position Centering (R115) so the display can be positioned an equal distance both above and below the center horizontal graticule line.

e. INTERACTION—CH 1 VAR VOLTS/DIV balance (R120).

Calibration—465 Service (SN B250000 & up)

15. Check Beam Finder Operation

a. Push the BEAM FINDER button and hold it in throughout checks b through d.

b. CHECK—Display remains visible regardless of the settings of the CH 1 POSITION and the HORIZONTAL POSITION controls.

c. CHECK—Display intensity is not affected when the setting of the INTENSITY control is changed.

d. Position the trace to the center horizontal graticule line. Set the HORIZONTAL POSITION control and the INTENSITY control to midrange.

e. Release the BEAM FINDER button and CHECK—Trace remains visible on the screen.

16. Check/Adjust Ch 1 and Vertical Output Gain

a. Set:

VERT MODE CH 1
 CH 1 & CH 2 AC-GND-DC DC
 CH 1 & CH 2 VOLTS/DIV 5 mV

b. Connect a 20 millivolt standard amplitude signal from the calibration generator to the CH 1 input via a 50 ohm unterminated BNC cable.

c. Connect two X10 probes from the test oscilloscope to TP322 and TP324 on the 465 Preamp board.

d. Set test oscilloscope:

VERT MODE ADD
 CH 2 INVERT Inverted
 CH 1 & CH 2 VOLTS/DIV 50 mV

e. CHECK—Test oscilloscope for a 200 millivolt (peak to peak) signal between TP322 and TP324.

NOTE

This is a nominal value and may vary 10% or more from instrument to instrument.

f. ADJUST—CH 1 Gain (R118) for a 200 millivolt (peak to peak) signal between TP322 and TP324.

g. Remove the X10 probes from TP322 and TP324.

h. CHECK—465 crt display for 4 divisions of deflection.

i. ADJUST—Vertical Output Gain (R4466) R400 for 4 divisions of display.

j. CHECK—Accuracy of all CH 1 VOLTS/DIV ranges according to Table 6-5.

TABLE 6-5

VERTICAL DEFLECTION FACTOR ACCURACY

VOLTS/DIV Switch Setting	Standard Amplitude Output	Vertical Deflection in Divisions
5 m	20 mV	3.88 to 4.12
10 m	50 mV	4.85 to 5.15
20 m	0.1 V	4.85 to 5.15
50 m	0.2 V	3.88 to 4.12
.1	0.5 V	4.85 to 5.15
.2	1 V	4.85 to 5.15
.5	2 V	3.88 to 4.12
1	5 V	4.85 to 5.15
2	10 V	4.85 to 5.15
5	20 V	3.88 to 4.12

17. Check/Adjust Ch 2 Gain

a. Set the VERT MODE switch to CH 2.

b. Adjust the calibration generator for a 20 millivolt output and move this signal to the CH 2 input.

c. CHECK—Display for 4 divisions of deflection.

d. ADJUST—CH 2 Gain (R218) for 4 divisions of deflection.

e. CHECK—Accuracy of all CH 2 VOLTS/DIV ranges according to Table 6-5.

18. Check Ch 1 & Ch 2 Variable Volts/Division Range

a. Set:

CH 1 & CH 2 VOLTS/DIV 10 mV
 Calibration generator
 output 50 mV

Calibration—465 Service (SN B250000 & up)

- b. Rotate the Ch 2 VAR control fully counterclockwise.
- c. CHECK—Display reduces to less than 2 divisions.
- d. Move the test signal to the CH 1 input connector.
- e. Set the VERT MODE switch to CH 1.
- f. Rotate the Ch 1 VAR control fully counterclockwise.
- g. CHECK—Display reduces to less than 2 divisions.
- h. Return the VAR controls to the detent positions.

19. Check Add Mode

a. Connect the calibration generator to both CH 1 & CH 2 via a dual input coupler and adjust for a 10 millivolt output.

b. Set:

VERT MODE	ADD
CH 1 & CH 2 VOLTS/DIV	5 mV

c. CHECK—Display for 3.88 to 4.12 divisions of deflection.

20. Check Compression and Expansion

a. Set:

CH 2 AC-GND-DC	GND
VERT MODE	CH 1

b. Adjust the calibration generator for a 20 millivolt output.

c. Adjust the CH 1 VAR control for exactly 2 divisions of deflection centered about the center horizontal graticule line.

d. Position the top of the display to the top graticule line.

e. CHECK—Display for 0.1 division or less of compression or expansion.

f. Position the bottom of the display to the bottom graticule line.

g. CHECK—Display for 0.1 division or less of compression or expansion.

h. Set the CH 1 VAR control to the detent position.

i. Disconnect the test setup.

21. Check/Adjust Vertical Output Low Frequency Compensation

a. Set:

A TIME/DIV	0.2 ms
CH 1 & CH 2 AC-GND-DC	DC
VERT MODE	CH 1

b. Connect the fast-rise + output of the Square-wave Generator to the CH 1 input via a GR-to-BNC adapter, 50 ohm BNC cable, X10 BNC attenuator, and a 50 ohm BNC termination.

c. Adjust the square-wave generator to maintain a 5 division display throughout this step.

d. Adjust the square-wave generator for a 1 kilohertz signal.

e. CHECK—Display for a flat-top waveform with 3% (0.15 division) or less overshoot or roll off.

f. ADJUST— R424 (IC version only) for the best flat-top waveform.

g. Set:

A TIME/DIV	20 μ s
------------	------------

h. Adjust the square-wave generator for a 10 kilohertz signal.

Calibration—465 Service (SN B250000 & up)

i. CHECK—Display for a flat-top waveform with 3% (0.15 division) or less overshoot or rolloff.

j. ADJUST—R4425 R434 for the best flat-top waveform.

k. Set the A TIME/DIV switch to 2 μ s.

l. Adjust the square-wave generator for a 100 kilohertz signal.

m. CHECK—Display for a flat-top waveform with 3% (0.15 division) or less overshoot or rolloff.

n. ADJUST—R4427 R433, R423 for the best flat-top waveform.

o. INTERACTION—Between all vertical Output Low Frequency adjustments.

22. Check/Adjust Ch 1 Volts/Division Compensation

a. Add a 20 picofarad normalizer to the test setup between the 50 ohm BNC termination and the CH 1 input.

b. Move the test setup from the fast-rise + output to the high-amplitude output of the square-wave generator and adjust the generator for a 1 kilohertz signal.

c. Adjust the square-wave generator amplitude for a 5 division display. Add or remove attenuators as necessary to maintain a 5 division display throughout this step.

d. CHECK—Display for a flat-top waveform with 3% or less overshoot or roll-off on the leading edge.

e. ADJUST—C1 with the low-capacitance screwdriver for the best flat-top waveform.

NOTE

If C1 does not have sufficient range C2 can be removed or replaced with a 2 picofarad capacitor. The nominal value is 1 picofarad.

f. Set the CH 1 VOLTS/DIV switch to 50 mV.

g. CHECK—Display for a flat-top waveform with 3%, or less, overshoot or roll-off on the leading edge.

h. ADJUST—Channel 1 C13 for the best flat-top waveform, and Channel 1 C12 for the best front corner with the low-capacitance screwdriver.

i. CAL AID—Remove the 20 picofarad normalizer when adjusting or checking the front corner response.

j. INTERACTION—Between Channel 1's C13 and C12. Readjust both for total optimum response.

k. Set the CH 1 VOLTS/DIV switch to 0.5 V.

l. CHECK—Display for a flat-top waveform with 3% or less overshoot or roll-off on the leading edge.

m. ADJUST—Channel 1 C11 for the best flat-top waveform, and Channel 1 C10 for the best front corner.

n. Set the CH 1 VOLTS/DIV switch to 5 V. It may be necessary to remove the 50 ohm termination to get 5 divisions of display at 5 volts/division.

o. CHECK—Display for a flat-top waveform with 3% or less overshoot or roll-off on the leading edge.

23. Check/Adjust Ch 2 Volts/Division Compensation

a. Set the VERT MODE switch to CH 2.

b. Connect the test setup to the CH 2 input.

c. Adjust the square-wave generator for a 5 division display. Add or remove attenuators as necessary to maintain a 5 division display.

d. CHECK—Display for a flat-top waveform with 3% or less overshoot or roll-off on the leading edge.

e. ADJUST—C51 with the low-capacitance screwdriver for the best flat-top waveform.

NOTE

If C51 does not have sufficient range, C52 can be removed or replaced with a 2 picofarad capacitor. The nominal value is 1 picofarad.

NOTE

Steps 24 through 29 are adjustment related. Perform all the checks in each of these steps before making any adjustments (unless calibration is being performed after repair or replacement of vertical components).

- f. Set the CH 2 VOLTS/DIV switch to 50 mV.
- g. CHECK—Display for a flat-top waveform with 3% or less overshoot or roll-off on the leading edge.
- h. ADJUST—Channel 2 C13 for the best flat-top waveform, and Channel 2 C12 for the best front corner with the low-capacitance screwdriver.
- i. CAL AID—Remove the 20 picofarad normalizer when adjusting or checking the front corner response.
- j. INTERACTION—Between Channel 2's C13 and C12. Readjust both for total optimum response.
- k. Set the CH 2 VOLTS/DIV switch to 0.5 V.
- l. CHECK—Display for a flat-top waveform with 3% or less overshoot or roll-off on the leading edge.
- m. ADJUST—Channel 2 C11 for the best flat-top waveform, and Channel 2 C10 for the best front corner with the low-capacitance screwdriver.
- n. INTERACTION—Between Channel 2's C11 and C10. Readjust both for optimum response.
- o. Set the CH 2 VOLTS/DIV switch to 5 V. It may be necessary to remove the 50 ohm BNC termination to get 5 divisions of display at 5 volts/division.
- p. CHECK—Display for a flat-top waveform with 3% or less overshoot or roll-off on the leading edge.
- q. Disconnect the test setup.

24. Check/Adjust Ch 2 and Vertical Output High Frequency Compensation

- a. Set:

CH 1 & CH 2 VOLTS/DIV	5 mV
A TIME/DIV	0.05 μ s
- b. Connect the fast rise, positive output of the square-wave generator to the CH 2 input via a GR to BNC adapter, 50 ohm BNC cable, X10 BNC Attenuator and 50 ohm BNC termination.

- c. Adjust the square-wave generator for a 5 division display of a 100 kilohertz signal. Add or remove attenuators as needed to maintain a 5 division display throughout this step.
- d. CHECK—Display for a flat-top waveform with aberrations of 3% peak-to-peak or less (0.15 division peak-to-peak for a 5 division display).
- e. CHECK—Display for a risetime of 3.5 nanoseconds or less.
- f. ADJUST—C77, C83, C205, R205, C249 and R249 on the Preamp board. Also C4428, R4438, C4422, R4422 on the discrete Vertical Output board.

Also C403, C442, R442 and C443 on the IC Vertical Output board.

- Adjust for the best flat-top display with aberrations of 3% peak-to-peak or less and a risetime of 3.5 nanoseconds or less.
- g. Move the test setup to the fast rise, negative output of the square-wave generator.
- h. Set the A TRIGGER SLOPE switch to —.
- i. CHECK—Display for a flat-bottom waveform with aberrations of 5% peak-to-peak or less. (0.25 division peak-to-peak for a 5 division display.)

25. Check Ch 2 Position Effect

- a. Position the bottom of the display to the top horizontal graticule line.
- b. CHECK—Display for a flat-bottom waveform with aberrations of 7% peak-to-peak or less (0.35 division with a 5 division display).
- c. Position the bottom of the display to the bottom horizontal graticule line.

Calibration—465 Service (SN B250000 & up)

d. CHECK—Display for a flat-bottom waveform with aberrations of 7% peak-to-peak or less (0.35 division with a 5 division display).

e. Move the test setup to the Fast rise, positive output of the square-wave generator.

f. Set the A TRIGGER SLOPE switch to +.

g. Position the top of the display to the top horizontal graticule line.

h. CHECK—Display for a flat-top waveform with aberrations of 5% peak-to-peak or less (0.25 division with a 5 division display).

i. Position the top of the display to the bottom horizontal graticule line.

j. CHECK—Display for a flat-top waveform with aberrations of 5% peak-to-peak or less (0.25 division with a 5 division display).

NOTE

If you have trouble with position effect and aberrations, then readjustment of the Vertical Output Bias (R455) could help. Readjust as follows:

Set the VOLTS/DIV switch to 5 mV. Adjust the square-wave generator for 5 divisions of + display. Move the top of the display from the top to the bottom of the graticule area while adjusting the Vertical Output Bias (R455). Adjust R455 for minimum observable change in the flat-top aberrations when moving the display from the top to the bottom of the graticule area.

INTERACTIONS:

Vertical Centering (steps 7, 13 and 14).

Vertical Output Gain (step 16i).

Compression and Expansion (step 20).

Vertical Output Low Frequency Compensation (step 21).

After readjustment for interactions, readjust according to step 24f and repeat the checks in the remainder of step 24 and step 25.

26. Check/Adjust Ch 2 10 mV and 20 mV High Frequency Compensation

a. Set the CH 2 VOLTS/DIV switch to 10 mV.

b. Adjust the square-wave generator for 5 divisions of display.

c. CHECK—Display for a flat-top waveform with aberrations of 3% peak-to-peak or less. (0.15 division with a 5 division display).

d. CHECK—Display for a risetime of 3.5 nanoseconds or less.

e. ADJUST—R97 and C97 for the best flat-top waveform with 3% peak-to-peak or less aberrations and a risetime of 3.5 nanoseconds or less.

f. Set the CH 2 VOLTS/DIV switch to 20 mV.

g. Adjust the square-wave generator for a 5 division display.

h. CHECK—Display for a flat-top waveform with aberrations of 3% peak-to-peak or less (0.15 division with a 5 division display).

i. CHECK—Display for a risetime of 3.5 nanoseconds or less.

j. ADJUST—R98 and C98 for the best flat-top waveform with 3% peak-to-peak or less aberrations and a risetime of 3.5 nanoseconds or less.

27. Check/Adjust Ch 1 High Frequency Compensation

a. Set the VERT MODE switch to CH 1.

b. Move the test setup from CH 2 to CH 1.

c. Adjust the square-wave generator for 5 divisions of display.

d. CHECK—Display for a flat-top waveform with aberrations of 3% peak-to-peak or less (0.15 division with a 5 division display).

e. CHECK—Display for a risetime of 3.5 nanoseconds or less.

f. ADJUST—C27, C33, C105, R105, C122, R122, C149 and R149 for the best flat-top waveform with aberrations of 3% peak-to-peak or less and a risetime of 3.5 nanoseconds or less.

g. Move the test setup to the fast rise, negative output of the square-wave generator.

h. Set the A TRIGGER SLOPE switch to —.

i. CHECK—Display for a flat-bottom waveform with aberrations of 5% peak-to-peak or less (0.25 division with a 5 division display).

28. Check Ch 1 Position Effect

a. Position the bottom of the display to the top horizontal graticule line.

b. CHECK—Display for a flat-bottom waveform with aberrations of 7% peak-to-peak or less (0.35 division with a 5 division display).

c. Position the bottom of the display to the bottom horizontal graticule line.

d. CHECK—Display for a flat-bottom waveform with aberrations of 7% peak-to-peak or less (0.35 division with a 5 division display).

e. Move the test setup to the Fast rise, positive output of the square-wave generator.

f. Set the A TRIGGER SLOPE switch to +.

g. Position the top of the display to the top horizontal graticule line.

h. CHECK—Display for a flat-top waveform with aberrations of 5% peak-to-peak or less (0.25 division with a 5 division display).

i. Position the top of the display to the bottom horizontal graticule line.

j. CHECK—Display for a flat-top waveform with aberrations of 5% peak-to-peak or less (0.25 division with a 5 division display).

29. Check/Adjust Ch 1 10 mV and 20 mV High Frequency Compensation

a. Set the CH 1 VOLTS/DIV switch to 10 mV.

b. Adjust the square-wave generator for 5 divisions of display.

c. CHECK—Display for a flat-top waveform with aberrations of 3% peak-to-peak or less (0.15 division with a 5 division display).

d. CHECK—Display for a risetime of 3.5 nanoseconds or less.

e. ADJUST—R47 and C47 for the best flat-top waveform with 3% peak-to-peak or less aberrations and a risetime of 3.5 nanoseconds or less.

f. Set the CH 1 VOLTS/DIV switch to 20 mV.

g. Adjust the square-wave generator for 5 divisions of display.

h. CHECK—Display for a flat-top waveform with aberrations of 3% peak-to-peak or less (0.15 division with a 5 division display).

i. CHECK—Display for a risetime of 3.5 nanoseconds or less.

j. ADJUST—R48 and C48 for the best flat-top waveform with 3% peak-to-peak or less aberrations and a risetime of 3.5 nanoseconds or less.

k. Remove the test setup.

30. Check Bandwidth

a. Set:

A TIME/DIV	About 5 μ s
A TRIGGER LEVEL	Fully clockwise (un-triggered display)
CH 1 & CH 2 VOLTS/DIV	5 mV

b. Connect the leveled sine-wave generator to the CH 1 input via a 50 ohm BNC cable, X10 BNC attenuator and a 50 ohm BNC termination.

Calibration—465 Service (SN B250000 & up)

c. Adjust the sine-wave generator for a 5 division display of a reference signal of about 50 kilohertz.

d. Set the generator to 100 megahertz. Do not change the generator amplitude adjustment.

e. CHECK—Display amplitude is 3.5 divisions or more.

f. Repeat steps c through e for all CH 1 VOLTS/DIV ranges from 10 mV to 2 V.

g. Set:

VERT MODE	CH 2
CH 2 VOLTS/DIV	5 mV

h. Move the test setup to the CH 2 input.

i. Repeat steps c through e for all CH 2 VOLTS/DIV ranges from 5 mV to 2 V.

31. Check Cascaded Gain and Bandwidth

a. Set:

CH 1 & CH 2 VOLTS/DIV	5 mV
A TIME/DIV	1 ms

b. Connect the CH 1 VERT SIGNAL OUT (on the rear panel) to the CH 2 input connector via a 50 ohm BNC cable and a 50 ohm BNC termination.

c. Connect a 5 millivolt standard amplitude signal from the calibration generator to the CH 1 input via a 50 ohm unterminated BNC cable.

d. CHECK—Display for at least 5 divisions of deflection.

e. Remove the standard amplitude signal from the CH 1 input.

f. Connect the output of the leveled sine-wave generator to the CH 1 input via a GR-to-BNC adapter, 50 ohm BNC cable, X10 BNC attenuator, and a 50 ohm BNC termination.

g. Adjust the leveled sine-wave generator for a 5 division display of a 50 kilohertz reference signal.

h. Adjust the leveled sine-wave generator for 50 megahertz. Do not change the generator amplitude adjustment.

i. CHECK—Display for an amplitude of 3.5 divisions or greater.

j. Disconnect the test setup.

32. Check Channel Isolation

a. Set:

CH 2 VOLTS/DIV	0.2 V
CH 1 AC-GND-DC	GND

b. Connect the leveled sine-wave generator to the CH 2 input via a 50 ohm BNC cable and a 50 ohm BNC termination.

c. Adjust the leveled sine-wave generator for a 2 division display of a 25 megahertz signal.

d. Set:

CH 1 & CH 2 VOLTS/DIV	20 mV (20 divisions of display in CH 2)
VERT MODE	CH 1

e. CHECK—Display for no more than 0.2 division of deflection (100:1 ratio).

f. Move the CH 2 input test setup to the CH 1 input.

g. Set:

CH 2 AC-GND-DC	GND
CH 1 AC-GND-DC	DC

h. CHECK—Display for no more than 0.2 division of deflection.

33. Check Common-Mode Rejection Ratio

a. Set:

CH 1 & CH 2 VOLTS/DIV	5 mV
CH 1 & CH 2 AC-GND-DC	DC
VERT MODE	CH 1
CH 2 INVERT	Inverted (pushed in)

Calibration—465 Service (SN B250000 & up)

b. Connect a 20 megahertz signal from the leveled sine-wave generator to the CH 1 and CH 2 inputs via a 50 ohm BNC cable, X10 BNC attenuator, 50 ohm BNC termination and dual-input coupler.

c. Set the generator for a 6 division display.

d. Set the VERT MODE switch to ADD.

e. CHECK—Display is 0.6 division or less (indicates cmrr of at least 10:1 at 20 megahertz).

f. Proceed to step I if CHECK meets requirement.

g. Set VERT MODE switch to CH 1.

h. Set the generator for a 6 division display of a 50 kilohertz reference signal.

i. Set the VERT MODE switch to ADD.

j. ADJUST—CH 2 Gain (R192) for minimum display (best cmrr).

k. Set the generator for 20 megahertz output frequency.

CHECK—Display is 0.6 division or less (indicates cmrr of at least 10:1 at 20 megahertz).

l. Set the CH 2 INVERT switch to normal (button out).

34. Check Bandwidth Limit Operation

a. Set:

20 MHz BW (PULL)	Pull out (shows yellow)
CH 1 AC-GND-DC	DC
VERT MODE	CH 1

b. Adjust the leveled sine-wave generator for 6 divisions of a 50 kilohertz reference signal.

c. Increase the generator output frequency until the display amplitude is 4.2 divisions.

d. CHECK—Generator output frequency is between 16 and 24 megahertz.

e. Disconnect the test setup.

TRIGGERS

Equipment Required	
1. Leveled Sine-wave Generator	8. GR to BNC Female Adapter
2. Low-frequency Generator	9. X10 BNC Attenuator
3. Time Mark Generator	10. 50 ohm BNC Termination (2 required)
4. Calibration Generator	11. Dual-input Coupler (2 required)
5. 50 ohm Signal Pickoff Unit (Type CT-3)	12. BNC T Connector
6. X10 Probe	13. 18-Inch, 50 ohm BNC Cable (2 required)
7. 42 Inch BNC Cable (2 required)	14. Female to Female BNC Adapter
	15. 3 Inch slotted Screwdriver

See **ADJUSTMENT LOCATIONS 2** and **ADJUSTMENT LOCATIONS 4** in the Diagrams section for adjustments and test points (TP).

465 Control Settings (*Indicates Change From the Previous Step)

Regulating Range Selector	Medium
Line Voltage Selector	115 V
POWER	ON

CRT Controls

INTENSITY	As desired
FOCUS	Best focused display
SCALE ILLUM	As desired

Vertical Controls (both channels if applicable)

*VOLTS/DIV	*10 mV
VAR	Calibrated detent
POSITION	Midrange
AC-GND-DC	DC
VERT MODE	CH 1
INVERT	Off (Button out)
*20 MHz BW (Pull)	*Off (No yellow showing)

Triggering Controls (both A and B if applicable)

LEVEL	Adjust as needed for a stable display
SLOPE	+
COUPLING	AC
SOURCE	NORM
TRIG MODE	AUTO

Sweep Controls

HORIZ DISPLAY	A
DELAY TIME POSITION	Fully counterclockwise
*A TIME/DIV	*0.05 μ s
*B TIME/DIV	*0.05 μ s
VAR TIME/DIV	Calibrated detent
X10 MAG	Off (button out)
POSITION	Midrange
FINE	Midrange
A TRIG HOLDOFF	NORM

1. Check/Adjust A Trigger Sensitivity and Triggered Lamp

a. Connect a 25 megahertz signal from the leveled sine-wave generator to the A and B external trigger inputs via CT-3 through output, GR to BNC female adapter, 50 ohm BNC Cable, X10 BNC Attenuator, 50 ohm BNC termination and a dual input coupler.

b. Connect CT-3 Sig Out 10% signal to CH 1 and CH 2 inputs via a 50 ohm BNC cable, 50 ohm BNC termination and a dual input coupler.

c. Adjust the leveled sine-wave generator for 3 divisions of display.

d. Set the CH 1 VOLTS/DIV switch to 0.1 V (0.3 division of display).

Calibration—465 Service (SN B250000 & up)

e. CHECK—A stable display can be obtained by rotating the A TRIGGER LEVEL control in both + and - slopes.

CHECK—TRIG lamp is on when the display is stable.

f. Set the CH 1 VOLTS/DIV switch to 5 mV and adjust the leveled sine-wave generator for 2 divisions of display.

g. Set the CH 1 VOLTS/DIV switch to 0.1 V (0.1 division of display).

h. CHECK—Stable display cannot be obtained by rotating the A TRIGGER LEVEL control in both + and - slopes. Return the A Slope control to +.

i. If the CHECKS in steps c through h meet the requirements, move on to step 2. If not, make the following ADJUSTMENTS.

j. Set the CH 1 VOLTS/DIV switch to 10 mV and adjust the leveled sine-wave generator for 2.5 divisions of display.

k. Set the CH 1 VOLTS/DIV switch to 0.1 V (0.25 division of display).

l. ADJUST—A Trigger Sensitivity (R655) so the display can just be triggered by rotating the A TRIGGER LEVEL control (Adjust with A Slope +).

m. Set the CH 1 VOLTS/DIV switch to 10 mV and adjust the leveled sine-wave generator for 2 divisions of display.

n. Set the CH 1 VOLTS/DIV switch to 0.1 V (0.2 division of display).

o. CHECK—Stable display cannot be obtained by adjusting the A TRIGGER LEVEL control in + slope only (- slope is generally slightly more sensitive).

If a stable display can be obtained, then the trigger is too sensitive.

READJUST—A Trigger Sensitivity slightly so that the display will just barely not trigger by adjusting the A TRIGGER LEVEL control (in + slope only).

p. Repeat steps j through o until a stable display can be obtained on 0.25 division of display, but not on 0.2 division of display (in the + slope only).

q. Repeat the CHECKS in steps c through h.

2. Check/Adjust B Trigger Sensitivity

a. Set:

HORIZ DISPLAY	B DLY'D
CH 1 VOLTS/DIV	10 mV
A TRIGGER LEVEL	Fully clockwise
B TRIGGER LEVEL	As needed for a stable display

b. Adjust the leveled sine-wave generator for 3 divisions of display.

c. Set the CH 1 VOLTS/DIV switch to 0.1 V (0.3 division of display).

d. CHECK—Stable display can be obtained by rotating the B TRIGGER LEVEL control in both + and - slopes.

e. Set the CH 1 VOLTS/DIV switch to 5 mV and adjust the sine-wave generator for 2 divisions of display.

f. Set the CH 1 VOLTS/DIV switch to 0.1 V (0.1 division of display).

g. CHECK—Stable display cannot be obtained by rotating the B TRIGGER LEVEL control in both + and - slopes. Return B SLOPE control to +.

h. If the CHECKS in steps b through g meet the requirements, move on to step 3. If not, make the following ADJUSTMENTS.

i. Set the CH 1 VOLTS/DIV switch to 10 mV and adjust the leveled sine-wave generator for 2.5 divisions of display.

j. Set the CH 1 VOLTS/DIV switch to 0.1 V (0.25 division of display).

k. ADJUST—B Trigger Sensitivity (R555) so the display can be just triggered by adjusting the B TRIGGER LEVEL control. (Adjust with B SLOPE in +).

Calibration—465 Service (SN B250000 & up)

l. Set the CH 1 VOLTS/DIV switch to 10 mV and adjust the leveled sine-wave generator for 2 divisions of display.

m. Set the CH 1 VOLTS/DIV switch to 0.1 V (0.2 division of display).

n. CHECK—Stable display cannot be obtained by adjusting the B TRIGGER LEVEL control in + slope only.

If a stable display can be obtained, then the trigger is too sensitive.

READJUST—B trigger Sensitivity (R555) so that the display will just barely not trigger by adjusting the B TRIGGER LEVEL control in + slope only.

o. Repeat steps i through n until a stable display can be obtained on 0.25 division of display but not on 0.2 division of display (in + slope only).

p. Repeat CHECKS in steps c through g.

3. Check/Adjust B Trigger Slope and Level Centering

a. Set:

B TRIGGER SOURCE	STARTS AFTER DELAY
A & B TIME/DIV	10 μ s
B TRIG LEVEL	0
CH 1 VOLTS/DIV	10 mV
CH 1 AC-GND-DC	GND

NOTE

The B TRIGGER LEVEL control must remain at 0 throughout step 3.

b. Position the trace to the center horizontal graticule line.

c. Set:

CH 1 AC-GND-DC	DC
B TRIGGER SOURCE	NORM

d. Adjust the leveled sine-wave generator for about 4 divisions of display of a 50 kilohertz signal.

e. Switch the B TRIGGER SLOPE switch between + and -.

CHECK—Display begins at about the same vertical point, within 1 division of graticule center, in both + and - slopes.

f. ADJUST—B Slope Center (R545) for the display to start at the same vertical point on the sine-wave (not necessarily the center horizontal graticule line). Return slope to +.

g. ADJUST—B Level Center (R535) to move the starting point of the display to the center horizontal graticule line.

4. Check/Adjust A Trigger Slope and Level Centering

a. Set:

HORIZ MODE	A
A TRIG LEVEL	0

NOTE

The A TRIGGER LEVEL control must remain at 0 throughout step 4.

b. Switch the A TRIGGER SLOPE switch between + and -.

c. CHECK—Display begins at about the same vertical point, within 1 division of graticule center, in both + and - slopes.

d. ADJUST—A Slope Center (R645) for the display to start at the same vertical point on the sine-wave (not necessarily the graticule center) in both + and - slopes. Return A SLOPE to +.

e. ADJUST—A Level Center (R635) to move the starting point of the display to the center horizontal graticule line.

5. Check/Adjust A Trigger DC Levels

a. Set the A COUPLING switch to DC.

NOTE

The A TRIGGER LEVEL control must remain at 0 throughout step 5.

b. CHECK—Start of the display is within 1 division of the center horizontal graticule line in both + and – slopes. Return A SLOPE to +.

c. ADJUST—Normal Trigger DC Balance (R340) to move the starting point of the display to the center horizontal graticule line.

d. INTERACTION—A + B LEVEL centering (R635 and R535).

e. Set the A SOURCE switch to CH 1.

f. CHECK—Start of the display is within 1 division of the center horizontal graticule line in both + and – slopes. Return A SLOPE to +.

g. ADJUST—CH 1 Trigger DC Balance (R155) to move the starting point of the display to the center horizontal graticule line.

h. Set the A SOURCE switch to CH 2.

i. CHECK—Start of the display is within 1 division of the center horizontal graticule line in both + and – slopes. Return A SLOPE to +.

j. ADJUST CH 2 Trigger DC Balance (R255) to move the starting point of the display to the center horizontal graticule line.

6. Check B Trigger DC Levels

a. Set:

HORIZ DISPLAY	B DLY'D
A TRIG LEVEL	Fully clockwise
B TRIG LEVEL	0
B COUPLING	DC
B SOURCE	NORM

NOTE

The B TRIGGER LEVEL control must remain at 0 during step 6.

b. CHECK—Start of the display is within 1 division of the center horizontal graticule line for the following B SOURCE switch positions:

NORM
CH 1
CH 2

7. Check B Internal 25 Megahertz Triggering

a. Set:

A & B TRIGGER COUPLING	AC
CH 1 VOLTS/DIV	10 mV
CH 2 VOLTS/DIV	0.1 V
A TIME/DIV	0.2 μ s
B TIME/DIV	0.05 μ s
A & B SOURCE	NORM

b. Adjust the leveled sine-wave generator for 3 divisions (30 millivolts) of a 25 megahertz display.

c. Set the CH 1 VOLTS/DIV switch to 0.1 V (0.3 division of display).

d. Adjust the B LEVEL control as needed for a stable display.

e. CHECK—For a stable display, with both + and – slopes for these modes:

B TRIGGER

SOURCE	COUPLING
NORM	AC, DC
CH 1	DC, AC
CH 2	AC, DC

f. Set:

CH 1 VOLTS/DIV	10 mV
B TRIGGER COUPLING	LF REJ

g. Adjust the leveled sine-wave generator for 5 divisions (50 millivolts) of a 25 megahertz display.

h. Set the CH 1 VOLTS/DIV switch to .1 V (0.5 division of display).

i. Adjust B LEVEL control as needed for a stable display.

j. CHECK—For a stable display, with both + and – slopes for these modes:

B TRIGGER SOURCE

CH 2
CH 1
NORM

Calibration—465 Service (SN B250000 & up)

k. Set the B TRIGGER COUPLING switch to HF REJ.

l. CHECK—No stable display for these modes:

B TRIGGER SOURCE

- NORM
- CH 1
- CH 2

8. Check A Internal 25 Megahertz Triggering

a. Set:

HORIZ DISPLAY	A
A TIME/DIV	.05 μ s
A TRIG LEVEL	As needed for a stable display
CH 1 VOLTS/DIV	10 mV

b. Adjust the leveled sine-wave generator for 3 divisions (30 millivolts) of a 25 megahertz display.

c. Set the CH 1 VOLTS/DIV switch to .1 V (0.3 division of display).

d. Adjust the A LEVEL control as needed for a stable display.

e. CHECK—For a stable display, with both + and - slopes for these modes:

A TRIGGER

SOURCE	COUPLING
NORM	AC, DC
CH 1	DC, AC
CH 2	AC, DC

f. Set:

CH 1 VOLTS/DIV	10 mV
A TRIGGER COUPLING	LF REJ

g. Adjust the leveled sine-wave generator for 5 divisions (50 millivolts) of a 25 megahertz display.

h. Set the CH 1 VOLTS/DIV switch to .1 V (0.5 division of display).

i. Adjust the A LEVEL control as needed for a stable display.

j. CHECK—Stable display, with both + and - slopes for these modes:

A TRIGGER SOURCE

- CH 2
- CH 1
- NORM

k. Set the A TRIGGER COUPLING switch to HF REJ.

l. CHECK—No stable display for these modes:

A TRIGGER SOURCE

- NORM
- CH 1
- CH 2

9. Check A External 25 Megahertz Triggering

a. Set:

CH 1 & CH 2 VOLTS/DIV	10 mV
A & B TRIGGER COUPLING	AC
A & B TRIGGER SOURCE	EXT

b. Adjust the leveled sine-wave generator to maintain 5 divisions of display throughout Steps 9 and 10. Adjust the A LEVEL control as needed for a stable display.

CHECK—For a stable display, with both + and - slopes for these modes:

A TRIGGER COUPLING

- AC, DC

c. Set:

CH 1 VOLTS/DIV	20 mV
A TRIGGER COUPLING	LF REJ

d. Adjust the leveled sine-wave generator for 5 divisions (100 millivolts) of a 25 megahertz display.

e. Adjust the A LEVEL control as needed for a stable display.

f. CHECK—Stable display, with both + and - slopes.

Calibration—465 Service (SN B250000 & up)

- g. Set the A TRIGGER COUPLING switch to HF REJ.
- h. CHECK—No stable display.
- i. Remove the X10 BNC attenuator from the external trigger setup and change the A TRIGGER SOURCE switch to EXT \div 10.
- j. CHECK—No stable display.
- k. Set the A TRIGGER COUPLING switch to LF REJ.
- l. CHECK—Stable display, with both + and – slopes.
- m. Set:

CH 1 VOLTS/DIV	10 mV
A TRIGGER COUPLING	AC
- n. Adjust the leveled sine-wave generator for 5 divisions (50 millivolts) of a 25 megahertz display. (0.5 volt at the external Trigger Input).
- o. CHECK—Stable display, with both + and – slopes for these modes:

A TRIGGER COUPLING

AC, DC

10. Check B External 25 Megahertz Triggering

- a. Set:

HORIZ DISPLAY	B DLY'D
A TIME/DIV	.2 μ s
B TIME/DIV	0.5 μ s
- b. Reconnect the X10 BNC attenuator to the external trigger setup.
- c. CHECK—Stable display, with both + and – slopes for these modes:

B TRIGGER COUPLING

AC, DC

- d. Set the CH 1 VOLTS/DIV switch to 20 mV.

- e. Adjust the leveled sine-wave generator for 5 divisions (100 millivolts) of a 25 megahertz display.

- f. Set the B TRIGGER COUPLING switch to LF REJ and adjust the B LEVEL control as needed for a stable display.

- g. CHECK—Stable display, with both + and – slopes.

- h. Set the B TRIGGER COUPLING switch to HF REJ.

- i. CHECK—No stable display.

11. Check B and A External 100 Megahertz Triggering

- a. Set:

A & B TRIGGER COUPLING	AC
B TRIGGER SOURCE	EXT
CH 1 VOLTS/DIV	50 mV

- c. Adjust the leveled sine-wave generator for 3 divisions (150 millivolts) of a 25 megahertz display, then change the frequency to 100 megahertz. Do not readjust signal amplitude.

- d. Push in the X10 MAG (IN) button and use the A and B LEVEL controls as needed for a stable display.

- e. CHECK—Stable display, with 0.1 division or less jitter, with + and – slopes for these modes:

B TRIGGER COUPLING

AC, DC

- f. Adjust the leveled sine-wave generator for 6 divisions (300 millivolts) of a 25 megahertz display, then change the frequency to 100 megahertz. Do not readjust the signal amplitude.

- g. Set the B TRIGGER COUPLING switch to LF REJ and use the A and B LEVEL controls as needed.

- h. CHECK—Stable display, with 0.1 division or less jitter, with both + and – slopes.

- i. Set the B TRIGGER COUPLING switch to HF REJ.

- CHECK—No stable display.

Calibration—465 Service (SN B250000 & up)

j. Set:

HORIZ DISPLAY A
 A TIME/DIV .05 μ s
 A TRIGGER MODE LF REJ
 A TRIGGER SOURCE EXT

k. Use the A LEVEL control as needed.

l. CHECK—Stable display, with 0.1 division or less jitter, with both + and – slopes.

m. Set the A TRIGGER COUPLING switch to HF REJ.

n. CHECK—No stable display.

o. Set the A TRIGGER COUPLING switch to AC.

p. Adjust the leveled sine-wave generator for 3 divisions (150 millivolts) of a 25 megahertz display, then change the frequency to 100 megahertz. Do not readjust the signal amplitude.

q. Use the A LEVEL control as needed for a stable display.

r. CHECK—Stable display, with 0.1 division or less jitter, with both + and – slopes:

A TRIGGER COUPLING

AC, DC

s. Remove the X10 BNC attenuator from the external trigger setup and change the A TRIGGER SOURCE switch to EXT \div 10.

t. Use the A LEVEL control as needed for a stable display.

u. CHECK—Stable display, with 0.1 division or less jitter, with both + and – slopes for these modes:

A TRIGGER COUPLING

DC, AC

v. Adjust the leveled sine-wave generator for 6 divisions (300 millivolts) of a 25 megahertz display, then change the frequency to 100 megahertz. Do not readjust the signal amplitude.

w. Set the A TRIGGER COUPLING switch to LF REJ and use the A LEVEL control as needed for a stable display.

x. CHECK—Stable display, with 0.1 division or less jitter, with both + and – slopes.

y. Set the A TRIGGER COUPLING switch to HF REJ.

z. CHECK—No stable display.

12. Check A Internal 100 Megahertz Triggering

a. Set:

CH 1 & CH 2 VOLTS/DIV 50 mV
 A & B TRIGGER SOURCE NORM
 A & B TRIGGER COUPLING AC

b. Reconnect the X10 attenuator to the external trigger setup. Adjust the leveled sine-wave generator for 1.5 divisions of a 100 megahertz display.

c. CHECK—Stable display, with 0.1 division or less jitter, with + and – slopes for these modes:

A TRIGGER

SOURCE	COUPLING
NORM	AC, LF REJ, DC
CH 1	DC, LF REJ, AC
CH 2	AC, LF REJ, DC

d. Set the A TRIGGER COUPLING switch to HF REJ.

e. CHECK—No stable display.

13. Check B Internal 100 Megahertz Triggering

a. Set:

HORIZ DISPLAY B DLY'D
 A TIME/DIV .2 μ s
 B TIME/DIV .05 μ s

b. CHECK—Stable display, with 0.1 division or less jitter, with + and - slopes, for these modes:

B TRIGGER

SOURCE	COUPLING
NORM	AC, LF REJ, DC
CH 1	DC, LF REJ, AC
CH 2	AC, LF REJ, DC

NOTE

It may be necessary to adjust both A and B LEVEL controls to obtain the most stable display at higher frequencies in B sweep.

c. Set the B TRIGGER COUPLING switch to HF REJ.

d. CHECK—No stable display.

14. Check A and B High Frequency Reject Triggering

a. Set:

HORIZ DISPLAY	A
A & B TIME/DIV	10 μ s
X10 MAG	Off (button out)
A & B TRIGGER COUPLING	HF REJ
A & B TRIGGER SOURCE	NORM
CH 1 VOLTS/DIV	.1 V
CH 2 VOLTS/DIV	10 mV
VERT MODE	CH 2

b. Adjust the leveled sine-wave generator for 5 divisions (50 millivolts) of a 50 kilohertz display.

c. Set the CH 2 VOLTS/DIV switch to .1 V. Adjust the A LEVEL control for a stable display.

d. Adjust the leveled sine-wave generator for 1 megahertz and push in the X10 MAG (IN) button.

e. CHECK—No stable display with the A TRIGGER SOURCE switch in NORM, CH 1 or CH 2.

g. Set:

A TRIGGER LEVEL	Fully clockwise
HORIZ DISPLAY	B DLY'D

h. CHECK—No stable display with the B TRIGGER SOURCE switch in NORM, CH 1 or CH 2.

15. Check Single Sweep

a. Set:

A TRIGGER COUPLING	AC
A SOURCE	NORM
A LEVEL	0
A SLOPE	+
HORIZ DISPLAY	A
CH 1 VOLTS/DIV	50 mV
VERT MODE	CH 1
X10 MAG (IN)	Off (button out)

b. Adjust the leveled sine-wave generator for 1 division of a 50 kilohertz display and adjust the A LEVEL control so the display is just triggered.

c. Set:

A & B TIME/DIV	10 ms
CH 1 AC-GND-DC	GND
TRIG MODE	SINGL SWP (push in)

d. CHECK—Ready lamp lights.

e. Set the CH 1 AC-GND-DC switch to DC.

f. CHECK—A single sweep occurs and the READY lamp goes out.

g. Press the SINGL SWP button.

h. CHECK—A single sweep occurs each time the SINGL SWP button is pressed.

i. Remove the test setup.

16. Check 60 Hertz Internal Triggering

a. Set:

A & B TIME/DIV	5 ms
A TRIGGER MODE	NORM
CH 1 VOLTS/DIV	10 mV

b. Connect the low-frequency generator signal to the CH 1 input via a 50 ohm BNC cable, BNC tee and 50 ohm BNC termination.

Calibration—465 Service (SN B250000 & up)

From BNC tee, connect a 50 ohm BNC cable and 50 ohm BNC termination to the B EXT input.

c. Adjust the low-frequency generator for 3 divisions (30 millivolts) of a 60 hertz display.

d. Set the CH 1 VOLTS/DIV switch to .1 V (0.3 division of display).

e. CHECK—Stable display, with both + and - slopes for these modes:

A TRIGGER COUPLING

AC, DC

f. Set:

CH 1 VOLTS/DIV	10 mV
A TRIGGER COUPLING	HF REJ

g. Set the low-frequency generator for 5 divisions (50 millivolts) of a 60 hertz display.

h. Set the CH 1 VOLTS/DIV switch to 0.1 V (0.5 division of display).

i. CHECK—Stable display, with both + and - slopes.

j. Set the A TRIGGER COUPLING switch to LF REJ.

k. CHECK—No stable display.

l. Set:

A TRIG MODE	AUTO
A LEVEL	Fully clockwise
A TIME/DIV	10 ms
B TIME/DIV	5 ms
B TRIGGER SOURCE	NORM
B TRIGGER COUPLING	HF REJ
HORIZ DISPLAY	B DLY'D
CH 1 VOLTS/DIV	.1 V

m. CHECK—Stable display, with both + and - slopes.

n. Set the B TRIGGER COUPLING switch to LF REJ.

o. CHECK—No stable display.

p. Set:

CH 1 VOLTS/DIV	10 mV
B TRIG COUPLING	AC

q. Set the low-frequency generator for 3 divisions (30 millivolts) of a 60 hertz display.

r. Set the CH 1 VOLTS/DIV switch to 0.1 V and use the B LEVEL control as needed for a stable display.

s. CHECK—Stable display, with both + and - slopes for these modes.

B TRIGGER COUPLING

AC, DC

17. Check 60 Hertz External Triggering

a. Set:

B TRIGGER COUPLING	AC
CH 1 VOLTS/DIV	10 mV

b. Adjust the low-frequency generator for 5 divisions (50 millivolts) of a 60 hertz display.

c. Set the B TRIGGER SOURCE switch to EXT.

d. CHECK—Stable display, with both + and - slopes for these modes:

B TRIGGER COUPLING

AC, HF REJ, DC

e. Set the B TRIGGER COUPLING switch to LF REJ.

f. CHECK—No stable display.

g. Move the signal cable from the B EXT input to the A EXT input.

h. Set:

HORIZ DISPLAY	A
A TIME/DIV	5 ms
A TRIGGER COUPLING	AC
A TRIG MODE	NORM
A SOURCE	EXT
A TRIGGER LEVEL	As needed

i. CHECK—Stable display, with both + and - slopes for these modes:

A TRIGGER COUPLING

AC, HF REJ, DC

j. Set the A TRIGGER COUPLING switch to LF REJ.

k. CHECK—No stable display.

18. Check A and B External Trigger Level Ranges

a. Set:

A & B TRIG COUPLING	AC
A & B TRIG SLOPE	+
CH 1 VOLTS/DIV	1 V
HORIZ MODE	A
A TRIG MODE	AUTO

b. Adjust the low frequency generator for 4 divisions (4 volts) of a 1 kilohertz display.

c. CHECK—Display is triggered along the positive slope of the waveform as the A TRIG LEVEL control is rotated.

d. CHECK—Display is not triggered (free runs) at both extremes of rotation.

e. Set the A TRIG SLOPE switch to -.

f. CHECK—Display is triggered along the negative slope of the waveform as the A TRIG LEVEL control is rotated.

g. CHECK—Display is not triggered (free runs) at both extremes of rotation.

h. Move the low frequency generator signal from the A EXT TRIGGER input to the B EXT TRIGGER input.

i. Set:

A TRIG LEVEL	Fully counterclockwise
HORIZ DISPLAY	B DLY'D

j. CHECK—Display is triggered along the positive slope of the waveform as the B TRIG LEVEL control is rotated.

k. CHECK—Display is not triggered (not visible) at both extremes of rotation.

l. Set the B TRIG SLOPE switch to -.

m. CHECK—Display is triggered along the negative slope of the waveform as the B TRIG LEVEL control is rotated.

n. CHECK—Display is not triggered (not visible) at both extremes of rotation.

o. Disconnect the test setup.

p. Set:

HORIZ MODE	A
A TRIG SOURCE	EXT ÷ 10
CH 1 VOLTS/DIV	5 V
CH 1 VAR	Fully counterclockwise
A COUPLING	AC

q. Connect a 50 volt standard amplitude signal from the calibration generator to the CH 1 input and the A EXT input via a 50 ohm BNC cable, BNC tee to CH 1 input, BNC cable from BNC tee to A EXT input.

NOTE

The range of the A LEVEL control with the A SOURCE switch in EXT ÷ 10, is ±20 volts (40 V peak-to-peak) or greater. The applied signal is 50 volts peak-to-peak. Therefore, untriggered operation at both extremes of the A LEVEL control is not required.

r. CHECK—Display is triggered along the negative slope of the waveform as the A LEVEL control is rotated.

s. Set the A SLOPE switch to +.

t. CHECK—Display is triggered along the positive slope of the waveform as the A LEVEL control is rotated.

u. Disconnect the test setup.

19. Check Line Triggers

a. Set:

A TRIGGER MODE	AUTO
A TRIGGER COUPLING	AC
A TRIGGER SOURCE	LINE
SLOPE	+
CH 1 VOLTS/DIV and VAR	As required

Calibration—465 Service (SN B250000 & up)

b. Connect a 10X probe from the CH 1 input to a line-frequency source.

CHECK—Stable display, starting on the positive-going slope.

c. Set the A TRIGGER SOURCE switch to —.

CHECK—Stable display, starting on the negative-going slope.

d. Disconnect probe from the line-frequency source, then from the 465.

20. Check A Normal Mode

a. Set:

A TIME/DIV	1 ms
A SLOPE	+
A TRIGGER SOURCE	NORM
A TRIGGER COUPLING	AC
A TRIGGER MODE	AUTO
CH 1 VOLTS/DIV	.5 V
CH 1 VAR	Calibrated detent

b. Connect 0.1 second time marks from the time-mark generator to the CH 1 input via a 50 ohm BNC cable and 50 ohm BNC termination.

c. CHECK—Display can be triggered by adjusting the A LEVEL control.

d. Set the A TRIG MODE switch to NORM.

e. CHECK—Display is triggered.

f. Set the CH 1 AC-GND-DC switch to GND.

g. CHECK—No display is visible.

21. Check Auto Recovery Time

a. Set:

CH 1 AC-GND-DC	DC
A TRIG MODE	AUTO

b. CHECK—Display is triggered.

c. Set the time-mark generator for 0.5 second time marks.

d. CHECK—Display cannot be triggered (free runs).

e. Disconnect the time-mark generator.

21. Check/Adjust Trigger View Centering

a. Set:

A TRIG COUPLING	AC
SOURCE	EXT
LEVEL	0
A TIME/DIV	.2 ms

b. Connect a 0.2 volt standard amplitude signal from the calibration generator to the A EXT trigger input via a 50 ohm BNC cable.

c. Push the TRIG VIEW button and hold it in.

d. CHECK—Display triggers symmetrically within 1 division of the graticule center line when the A TRIGGER SLOPE switch is switched between + and —.

e. ADJUST—Trig View Centering (R675) to center the display about the center horizontal graticule line.

f. Rotate the A LEVEL control (with the TRIG VIEW button pushed in).

g. CHECK—Display top and bottom are triggered within 1 division of the graticule center line.

h. Set the A TRIG COUPLING switch to DC.

i. CHECK—Display top and bottom are triggered within 1 division of the graticule center line.

22. Check Trigger View Gain

a. Push the TRIG VIEW button and hold it in.

b. CHECK—Display amplitude is 3.2 to 4.8 divisions.

c. Disconnect the calibration generator.

IMPORTANT NOTE

OSCILLOSCOPES WITH DIGITAL MULTIMETERS ATTACHED, REFER TO THE CALIBRATION SECTION OF THE DIGITAL MULTIMETER MANUAL AT THIS POINT. ON COMPLETION OF THE CALIBRATION SECTION IN THE DM MANUAL RETURN TO THIS MANUAL AND COMPLETE STEPS 19 & 20 IN THE HORIZONTAL SECTION, THEN CONTINUE ON TO THE NEXT SECTION.

FOR CALIBRATION OF OSCILLOSCOPES WITHOUT DIGITAL MULTIMETERS, CONTINUE TO HORIZONTAL SECTION OF THIS MANUAL.

HORIZONTAL

Equipment Required

- | | |
|------------------------|--|
| 1. Test Oscilloscope | 4. 50 ohm BNC Termination |
| 2. Time Mark Generator | 5. 3-Inch slotted Screwdriver |
| 3. 50 ohm BNC Cable | 6. Low Capacitance slotted Screwdriver |

See **ADJUSTMENT LOCATIONS 1** and **ADJUSTMENT LOCATIONS 5** in the Diagrams section for adjustments and test points (TP).

465 Control Settings (*Indicates Change From Previous Step)

Power Controls

Regulating Range Selector Medium
 Line Voltage Selector 115 V
 POWER ON

CRT Controls

INTENSITY As desired
 FOCUS Best focused display
 SCALE ILLUM As desired

**Vertical Controls
 (both Channels if applicable)**

VOLTS/DIV 0.5 V
 VAR Calibrated detent
 POSITION Midrange
 AC-GND-DC DC
 VERT MODE CH 1
 INVERT Off (button out)
 20 MHz BW (Pull) Off (No yellow showing)

**Triggering Controls
 (both A and B if applicable)**

LEVEL As needed for a stable display
 SLOPE +
 *COUPLING *AC
 *A SOURCE *NORM
 *B SOURCE *Starts after delay

Sweep Controls

*HORIZ DISPLAY *A INTEN
 *DELAY TIME POSITION *1.00
 *A TIME/DIV *1 ms
 *B TIME/DIV *5 μs
 VAR TIME/DIV Calibrated detent
 X10 MAG Off (button out)
 POSITION Midrange
 FINE Midrange
 A TRIG HOLDOFF NORM

1. Check/Adjust Sweep Start and A Sweep Calibration

a. Connect 1 millisecond time marks to the CH 1 input from the time mark generator via a 50 ohm BNC cable and a 50 ohm BNC termination.

Calibration—465 Service (SN B250000 & up)

b. CHECK—Intensified portion of the sweep begins at the second time marker. (It may be necessary to readjust the INTENSITY control so that the intensified portion of the sweep is visible.)

c. ADJUST—Sweep Start (R1115) so the intensified portion of the sweep begins at the start of the second time marker.

d. Set the DELAY TIME POSITION dial to 9.00.

e. CHECK—Intensified portion of the sweep begins at the tenth time marker.

f. ADJUST—A Sweep Cal (R1145) so the intensified portion of the sweep begins at the start of the tenth time marker.

g. Set:

HORIZ DISPLAY	B DLY'D
DELAY TIME POSITION	1.00

h. CHECK—Displayed pulse starts at the beginning of the sweep.

i. ADJUST—Sweep Start (R1115) so the displayed pulse starts at the beginning of the sweep.

j. Set the DELAY TIME POSITION dial to 9.00.

k. CHECK—Displayed pulse starts at the beginning of the sweep.

l. ADJUST—A Sweep Cal (R1145) so the displayed pulse starts at the beginning of the sweep.

m. INTERACTION—Between Sweep Start and A Sweep Cal adjustments. Repeat both for no visible interaction.

2. Check Delay or Differential Time Linearity

a. Set the DELAY TIME POSITION dial to position the tenth time marker to the beginning of the sweep.

b. Note the reading on the DELAY TIME POSITION dial.

c. Adjust the DELAY TIME POSITION dial so the ninth time marker is at the beginning of the sweep.

d. CHECK—DELAY TIME POSITION dial for a reading 1 division less, within 0.01 division from +15°C to +35°C; 1 division less, within 0.03 division from -15°C to +55°C, than the reading noted in step c.

NOTE

1 division of the DELAY TIME POSITION dial is one complete revolution of the inner knob. 0.01 division is one minor division of the inner knob.

e. Rotate the DELAY TIME POSITION dial to position each successive time marker to the beginning of the sweep.

f. CHECK—DELAY TIME POSITION dial for a reading of 1 division less, within 0.01 division from +15°C to +35°C; 1 division less, within 0.03 division from -15°C to +55°C, than the adjacent time marker.

3. Check/Adjust Horizontal Amplifier Gain

a. Set:

HORIZ DISPLAY	A
A and B TIME/DIV	1 ms
DELAY TIME POSITION	Fully counterclockwise

b. Select 1 millisecond time marks from the time mark generator.

c. CHECK—Display for 1 marker/division $\pm 2\%$ (± 1 minor division at the eleventh time marker).

d. ADJUST—X1 Gain (R1237) for exactly 1 marker/division.

e. Select 0.1 millisecond time marks from the time mark generator.

f. Push the X10 MAG button.

g. CHECK—X10 MAG light is on when the X10 MAG button is pushed in.

h. CHECK—1 marker/division $\pm 3\%$ ($\pm 1 \frac{1}{2}$, minor divisions at the eleventh time marker).

i. ADJUST—X10 Gain (R1238) for exactly 1 time marker/division.

4. Check Sweep Linearity

a. CHECK—Linearity over any 2 divisions of the magnified sweep to be within 0.1 division.

b. Release the X10 MAG button.

c. Select 1 millisecond time marks from the time mark generator.

d. CHECK—Linearity over any 2 divisions of the sweep to be within 0.1 division.

5. Check/Adjust Magnifier Registration

a. Push the X10 MAG button in.

b. Select 5 millisecond time markers from the time mark generator.

c. Position the middle time marker to the center vertical graticule line.

d. Release the X10 MAG button.

e. CHECK—Middle time marker is within 0.2 division of the center vertical graticule line.

f. ADJUST—Magnifier Registration (R1225) to position the middle time marker to the center vertical graticule line.

g. Repeat steps c through f until no horizontal shift is observed between X10 MAG in and X10 MAG out.

6. Check/Adjust B Sweep Calibration

a. Set:

DELAY TIME POSITION	Fully counterclockwise
HORIZ DISPLAY	B DLY'D
A TIME/DIV	2 ms
B TIME/DIV	1 ms
X10 MAG	Off (button out)

b. Select 1 millisecond time marks from the time mark generator.

c. CHECK—Display for 1 time marker/division $\pm 2\%$ (1 minor division at the eleventh time marker).

d. ADJUST—B Sweep Cal (R1175) for exactly 1 time marker/division.

7. Check A Sweep Length

a. Set:

A & B TIME/DIV	1 ms
HORIZ DISPLAY	A

b. Select 1 millisecond and 5 millisecond time marks.

c. Position the third taller time mark horizontally to the center vertical graticule line.

d. CHECK—Display extends to the right of the center vertical graticule line 1 division (± 0.5 division).

8. Check Variable Time/Division

a. Set the A TIME/DIV switch to 2 ms.

b. Select 5 millisecond time marks from the time mark generator.

c. CHECK—At least 1 time marker per division can be obtained by adjusting the VAR TIME/DIV control.

d. CHECK—UNCAL light comes on when the VAR TIME/DIV control is out of the detent position.

e. Return the VAR TIME/DIV control to the detent position.

9. Check Horizontal Position Range

a. Set the horizontal FINE position to midrange.

b. Turn the horizontal POSITION control fully clockwise.

c. CHECK—Start of sweep is to the right of the center vertical graticule line.

d. Turn the horizontal POSITION control fully counterclockwise.

Calibration—465 Service (SN B250000 & up)

e. CHECK—End of sweep is to the left of the center vertical graticule line.

f. Rotate the horizontal FINE position control.

g. CHECK—FINE position control will position the sweep between one and two divisions.

10. Check/Adjust A 10 Microsecond Timing

a. Set:

DELAY TIME POSITION	
DIAL	1.00
A TIME/DIV	10 μ s
B TIME/DIV	.1 μ s

b. Select 10 microsecond time marks from the time mark generator.

c. CHECK—Display for 1 time mark/division $\pm 2\%$ (1 minor division at the eleventh time marker).

d. ADJUST—10 microsecond timing (C1136) for exactly 1 time marker/division.

e. Set the HORIZ DISPLAY switch to B DLY'D.

f. Horizontally position the display so the displayed marker crosses the center vertical graticule line.

g. Set the DELAY TIME POSITION DIAL to 9.00.

h. ADJUST—10 microsecond timing (C1136) so the displayed marker crosses the center vertical graticule line.

i. Repeat steps f through h until no error exists between a DELAY TIME POSITION dial setting of 1.00 and 9.00.

11. Check/Adjust A Sweep High Speed Timing

a. Set:

DELAY TIME POSITION	1.50
B SOURCE	STARTS AFTER DELAY
A TIME/DIV	0.5 μ s
B TIME/DIV	0.05 μ s

b. Select 0.5 microsecond time marks from the time mark generator.

c. CHECK—Display for 1 time marker/division $\pm 2\%$ (1 minor division at the eleventh time marker).

d. ADJUST—A High Speed Timing (C1137) with the low-capacitance screwdriver, for exactly 1 time marker/division.

e. Switch the HORIZ DISPLAY switch to B DLY'D.

f. Set the horizontal POSITION control so the displayed time marker crosses the center vertical graticule line.

g. Set the DELAY TIME POSITION dial to 8.50.

h. CHECK—Displayed time marker crosses the center vertical graticule line.

i. ADJUST—A High Speed Timing (C1137) so the displayed time marker crosses the center vertical graticule line.

j. INTERACTION—Between the two positions of the DELAY—TIME POSITION dial when adjusting C1137. Compromise the adjustments as necessary to achieve correct timing.

12. Check/Adjust B Sweep High Speed Timing

a. Set:

DELAY TIME POSITION	Fully counterclockwise
HORIZ DISPLAY	B DLY'D
B TRIG SOURCE	NORM
A TIME/DIV	1 μ s
B TIME/DIV	0.5 μ s

b. Adjust the A and B LEVEL controls for a stable display.

c. CHECK—Display for 1 time marker/division $\pm 2\%$ (1 minor division at the eleventh time marker).

d. ADJUST—B High Speed Timing (C1167) for exactly 1 time marker/division.

13. Check A and B Time/Division Accuracy

a. CHECK—Using the B TIME/DIV switch and the time mark generator settings given in Table 6-6, check B sweep timing, within 0.2 division, over the first 10 divisions of the display.

b. Set the HORIZ DISPLAY switch to A.

c. CHECK—Using the A TIME/DIV switch and the time mark generator settings given in Table 6-6 check A sweep timing within 0.2 division, over the first 10 divisions of the display.

**TABLE 6-6
A AND B TIMING ACCURACY**

A and B TIME/DIV Switch Setting	Time-Mark Generator Output	CRT Display (Markers/Division)
0.05 μ s	50 ns	1
.1 μ s	0.1 μ s	1
.2 μ s	0.1 μ s	2
.5 μ s	0.5 μ s	1
1 μ s	1 μ s	1
2 μ s	1 μ s	2
5 μ s	5 μ s	1
10 μ s	10 μ s	1
20 μ s	10 μ s	2
50 μ s	50 μ s	1
.1 ms	0.1 ms	1
.2 ms	0.1 ms	2
.5 ms	0.5 ms	1
1 ms	1 ms	1
2 ms	1 ms	2
5 ms	5 ms	1
*10 ms	10 ms	1
*20 ms	10 ms	2
*50 ms	50 ms	1
A SWEEP ONLY		
*.1 s	0.1 s	1
*.2 s	0.1 s	1
*.5 s	0.5 s	1

*Switch A TRIG MODE to NORM below 5 ms/div.

14. Check/Adjust High Speed Magnified Timing

a. Set:

- X10 MAG On (button pushed in)
- HORIZONTAL POSITION Midrange
- A TIME/DIV 0.05 μ s
- A TRIG MODE Auto

b. Select the 10 nanosecond sine-wave output from the time mark generator.

c. CHECK—Display for 1 cycle/2 divisions, within 0.3 division over the full 10 horizontal graticule divisions. Disregard the first and last 10 divisions (5 cycles) of sweep length. See Table 6-7.

d. ADJUST—Magnifier Timing (C1261 and C1281), with the low-capacitance screwdriver for 1 cycle/2 divisions. Disregard the first and last 10 divisions (5 cycles) of sweep length.

15. Check A and B Magnified Timing Accuracy

a. CHECK—Using the A TIME/DIV switch settings and the time mark generator settings given in Table 6-7 check A magnified sweep timing, within 0.3 division over the center 10 divisions of the magnified display. Note the portions of the total magnified sweep length to be excluded from the measurement.

**TABLE 6-7
A AND B MAGNIFIED ACCURACY**

A and B TIME/DIV Switch Setting	Time-Mark Generator Output	CRT Display (Markers/Division)	Portions of total magnified sweep length to exclude from measurement
0.05 μ s	5 ns	1	First and last 10 divisions
.1 μ s	10 ns	1	First and last 5 divisions
.2 μ s	10 ns	2	First and last 2.5 divisions
.5 μ s	50 ns	1	
1 μ s	0.1 μ s	1	
2 μ s	0.1 μ s	2	
5 μ s	0.5 μ s	1	
10 μ s	1 μ s	1	
20 μ s	1 μ s	2	
50 μ s	5 μ s	1	
.1 ms	10 μ s	1	
.2 ms	10 μ s	2	
.5 ms	50 μ s	1	
1 ms	0.1 ms	1	
2 ms	0.1 ms	2	
5 ms	0.5 ms	1	
*10 ms	1 ms	1	
*20 ms	1 ms	2	
*50 ms	5 ms	1	
A SWEEP ONLY			
*.1 s	10 ms	1	
*.2 s	10 ms	2	
*.5 s	50 ms	1	

*Switch TRIG MODE to NORM below 5 ms/div.

Calibration—465 Service (SN B250000 & up)

b. Select 1 millisecond time marks from the time mark generator.

c. CHECK—Timing between the second and tenth time markers. Note any timing error for use in step e.

d. Set the HORIZ DISPLAY switch to MIX.

e. CHECK—Timing between second and tenth time markers is within 0.16 division, \pm the A Sweep error noted in step c.

f. Disconnect the test setup.

19. Check/Adjust X Gain

a. Set:

A and B TIME/DIV	X-Y
VERT MODE	CH 2
CH 1 and CH 2	
VOLTS/DIV	5 mV
CH 1 AC-GND-DC	AC
CH 2 AC-GND-DC	GND
HORIZ MODE	A

b. Connect a 20 millivolt standard amplitude signal from the calibration generator to the CH 1 input via a 50 ohm unterminated BNC cable.

c. CHECK—Display for 4 divisions of horizontal deflection $\pm 4\%$ (0.16 division).

d. Switch the CH 1 AC-GND-DC switch to DC.

e. CHECK—Display for 4 divisions of horizontal deflection $\pm 4\%$ (0.16 division). It is normal for this check to be slightly less than that observed in step c.

f. Set the CH 1 AC-GND-DC switch to AC.

g. ADJUST—X Gain (R1215) for exactly 4 divisions of horizontal deflection.

20. Check X-Y Phasing and Bandwidth

a. Connect the output of the leveled sine-wave generator to the Ch 1 and CH 2 inputs via a 50 ohm BNC cable, 50 ohm BNC termination, and a dual input coupler.

b. Adjust the leveled sine-wave generator for an 8 division horizontal display of 50 kilohertz.

c. Set the CH 2 AC-GND-DC switch to AC.

d. Center the display vertically and horizontally with the HORIZ POSITION and CH 2 POSITION controls.

e. CHECK—Display for an opening at the center horizontal graticule line of 0.4 division or less.

f. Set the CH 2 AC-GND-DC switch to GND.

g. Adjust the leveled sine-wave generator for a 10 division horizontal display of 50 kilohertz.

h. Increase the leveled sine-wave generator frequency until the display is reduced to 7 divisions.

i. CHECK—Output frequency of the leveled sine-wave generator is at least 4 megahertz.

j. Disconnect the test setup.

21. Check B Ends A

a. Set:

HORIZ DISPLAY	A INTEN
A TIME/DIV	1 ms
B TIME/DIV	0.1 ms
A TRIG HOLDOFF	B ENDS A (in detent)

b. Adjust the INTENSITY control so the A sweep portion of the display is visible.

c. Rotate the DELAY TIME POSITION dial through its range.

d. CHECK—A sweep ends after the intensified portion at all settings of the DELAY TIME POSITION dial.

22. Check A Trigger Holdoff

a. Set:

HORIZ DISPLAY	A
A TRIG HOLDOFF	Fully counterclockwise
A TRIGGER LEVEL	Fully clockwise

Calibration—465 Service (SN B250000 & up)

b. Connect the A GATE output signal to the test oscilloscope via a 50 ohm BNC cable.

c. Set the test oscilloscope TIME/DIV switch and VAR TIME/DIV so that the bottom portion of the waveform (holdoff time of the A GATE) is exactly 1 division in length.

d. Rotate the A TRIG HOLDOFF control clockwise.

e. CHECK—At least 10 times increase in the holdoff time of the A GATE.

f. Set the A TRIG HOLDOFF control fully counterclockwise.

GATES, CALIBRATOR AND EXT Z AXIS

Equipment Required

- | | |
|---|-------------------------------|
| 1. Test Oscilloscope | 4. Shorting Strap |
| 2. 42 Inch, 50 ohm BNC cable (2 required) | 5. Calibration Generator |
| 3. Digital Voltmeter | 6. BNC Tee Connector |
| | 7. 3 Inch slotted Screwdriver |

See **ADJUSTMENT LOCATIONS 1** in the Diagrams section for adjustments and test points (TP).

465 Control Settings (*Indicates Change From Previous Step)

Power Controls

Regulating Range Selector	Medium
Line Voltage Selector	115 V
POWER	ON

CRT Controls

INTENSITY	As desired
FOCUS	Best focused display
SCALE ILLUM	As desired

Vertical Controls

(both Channels if applicable)

VOLTS/DIV	5 mV
VAR	Calibrated detent
POSITION	Midrange
VERT MODE	CH 1
INVERT	Off (button out)
20 MHz BW (Pull)	Off (No yellow showing)

Triggering Controls

(both A and B if applicable)

LEVEL	Fully clockwise
SLOPE	+
COUPLING	AC
A SOURCE	NORM
B SOURCE	STARTS AFTER DELAY
TRIG MODE	AUTO

Sweep Controls

*HORIZ DISPLAY	*B DLY'D
*DELAY TIME POSITION	*Fully counterclockwise
*A TIME/DIV	*50 μ s
*B TIME/DIV	*50 μ s
VAR TIME/DIV	Calibrated detent
X10 MAG	Off (button out)
POSITION	Midrange
FINE	Midrange
A TRIG HOLDOFF	NORM

1. Check A and B +Gates

a. Set:

DELAY TIME POSITION	Fully counterclockwise
HORIZ DISPLAY	B DLY'D
A and B TIME/DIV	50 μ s

b. Connect the B +Gate output (from the back of the 465) to the test oscilloscope via a 50 ohm BNC cable.

c. CHECK—Test oscilloscope display for a positive going pulse of 5.5 volts in amplitude (within 0.5 volt).

d. Disconnect the cable from the B \pm GATE output and connect it to the A +GATE output.

e. CHECK—Test oscilloscope display for a positive going pulse of 5.5 volts in amplitude (within 0.5 volt).

Calibration—465 Service (SN B250000 & up)

2. Check/Adjust Calibrator DC Level

a. Connect a shorting strap between TP1594 and TP1590.

b. Connect the digital voltmeter between the CALIBRATOR current loop and ground.

c. CHECK—CALIBRATOR dc level is 300 millivolts $\pm 0.3\%$ (299.1 to 300.9 millivolts).

d. ADJUST—Calibrator Amplitude (R1597) for exactly 300 millivolts.

e. Remove the shorting strap and the digital voltmeter connections.

f. Connect a X10 probe from the test oscilloscope to the CALIBRATOR current loop.

g. CHECK—Test oscilloscope display for a 0.3 volt squarewave with a duration of about 1 millisecond.

h. Remove the test setup.

3. Check External Z Axis

a. Set:

HORIZ DISPLAY	A
A TIME/DIV	0.2 ms
A TRIGGER SOURCE	EXT

b. Set the INTENSITY control for a normal viewing level.

c. Connect a 5 volt standard amplitude signal from the calibration generator via a 50 ohm BNC cable, BNC T connector to the A EXT trigger input, BNC cable from BNC tee to EXT Z AXIS input.

d. Adjust A LEVEL for a stable display (TRIG light on).

e. CHECK—Display for noticeable intensity modulation.

f. Disconnect the test setup.

REPLACEABLE ELECTRICAL PARTS

PARTS ORDERING INFORMATION

Replacement parts are available from or through your local Tektronix, Inc. Field Office or representative.

Changes to Tektronix instruments are sometimes made to accommodate improved components as they become available, and to give you the benefit of the latest circuit improvements developed in our engineering department. It is therefore important, when ordering parts, to include the following information in your order: Part number, instrument type or number, serial number, and modification number if applicable.

If a part you have ordered has been replaced with a new or improved part, your local Tektronix, Inc. Field Office or representative will contact you concerning any change in part number.

Change information, if any, is located at the rear of this manual.

SPECIAL NOTES AND SYMBOLS

X000 Part first added at this serial number
00X Part removed after this serial number

ITEM NAME

In the Parts List, an Item Name is separated from the description by a colon (:). Because of space limitations, an Item Name may sometimes appear as incomplete. For further Item Name identification, the U.S. Federal Cataloging Handbook H6-1 can be utilized where possible.

ABBREVIATIONS

ACTR	ACTUATOR	PLSTC	PLASTIC
ASSY	ASSEMBLY	QTZ	QUARTZ
CAP	CAPACITOR	RECP	RECEPTACLE
CER	CERAMIC	RES	RESISTOR
CKT	CIRCUIT	RF	RADIO FREQUENCY
COMP	COMPOSITION	SEL	SELECTED
CONN	CONNECTOR	SEMICOND	SEMICONDUCTOR
ELCTLT	ELECTROLYTIC	SENS	SENSITIVE
ELEC	ELECTRICAL	VAR	VARIABLE
INCAND	INCANDESCENT	WW	WIREWOUND
LED	LIGHT EMITTING DIODE	XFMR	TRANSFORMER
NONWIR	NON WIREWOUND	XTAL	CRYSTAL

CROSS INDEX MFR. CODE NUMBER TO MANUFACTURER

MFR.CODE	MANUFACTURER	ADDRESS	CITY,STATE,ZIP
00779	AMP, INC.	P. O. BOX 3608	HARRISBURG, PA 17105
00853	SANGAMO ELECTRIC CO., S. CAROLINA DIV.	P. O. BOX 128	PICKENS, SC 29671
01002	GENERAL ELECTRIC CO., INDUSTRIAL AND POWER CAPACITOR PRODUCTS DEPT.	JOHN ST.	HUDSON FALLS, NY 12839
01121	ALLEN-BRADLEY CO.	1201 2ND ST. SOUTH	MILWAUKEE, WI 53204
01281	TRW ELECTRONIC COMPONENTS, SEMICONDUCTOR OPERATIONS	14520 AVIATION BLVD.	LAWDALE, CA 90260
01295	TEXAS INSTRUMENTS, INC., SEMICONDUCTOR GROUP	P. O. BOX 5012	DALLAS, TX 75222
01963	CHERRY ELECTRICAL PRODUCTS CORP.	3600 SUNSET AVE.	WAUKEGAN, IL 60085
02111	SPECTROL ELECTRONICS CORP.	17070 EAST GALE AVE.	CITY OF INDUSTRY, CA 91745
02735	RCA CORP., SOLID STATE DIVISION	ROUTE 202	SOMERVILLE, NY 08876
03508	GENERAL ELECTRIC CO., SEMI-CONDUCTOR PRODUCTS DEPT.	ELECTRONICS PARK	SYRACUSE, NY 13201
04713	MOTOROLA, INC., SEMICONDUCTOR PRODUCTS DIV.	5005 E. MCDOWELL RD.	PHOENIX, AZ 85036
07263	FAIRCHILD SEMICONDUCTOR, A DIV. OF FAIRCHILD CAMERA AND INSTRUMENT CORP.	464 ELLIS ST.	MOUNTAIN VIEW, CA 94042
07910	TELEDYNE SEMICONDUCTOR	12515 CHADRON AVE.	HAWTHORNE, CA 90250
08806	GENERAL ELECTRIC CO., MINIATURE LAMP PRODUCTS DEPT.	NELA PK.	CLEVELAND, OH 44112
09353	C AND K COMPONENTS, INC.	103 MORSE STREET	WATERTOWN, MA 02172
12040	NATIONAL SEMICONDUCTOR CORP.	COMMERCE DRIVE	DANBURY, CT 06810
12697	CLAROSTAT MFG. CO., INC.	LOWER WASHINGTON ST.	DOVER, NH 03820
12969	UNITRODE CORP.	580 PLEASANT ST.	WATERTOWN, MA 02172
13715	FAIRCHILD SEMICONDUCTOR, A DIV. OF FAIRCHILD CAMERA AND INSTRUMENT CORP.	4300 REDWOOD HWY.	SAN RAFAEL, CA 94903
14193	CAL-R, INC.	1601 OLYMPIC BLVD.	SANTA MONICA, CA 90404
14936	GENERAL INSTRUMENT CORP., SEMICONDUCTOR PRODUCTS GROUP	600 W. JOHN ST.	HICKSVILLE, NY 11802
17856	SILICONIX, INC.	2201 LAURELWOOD RD.	SANTA CLARA, CA 95054
18324	SIGNETICS CORP.	811 E. ARQUES	SUNNYVALE, CA 94086
24931	SPECIALTY CONNECTOR CO., INC.	3560 MADISON AVE.	INDIANAPOLIS, IN 46227
25088	SIEMENS CORP.	186 WOOD AVE. S	ISELIN, NJ 08830
25403	AMPEREX ELECTRONIC CORP., SEMICONDUCTOR AND MICROCIRCUITS DIV.	PROVIDENCE PIKE	SLATERSVILLE, RI 02876
28480	HEWLETT-PACKARD CO., CORPORATE HQ.	1501 PAGE MILL RD.	PALO ALTO, CA 94304
32293	INTERSIL, INC.	10900 N. TANTAU AVE.	CUPERTINO, CA 95014
34553	AMPEREX ELECTRONIC CORP., COMPONENT DIV.	35 HOFFMAN AVE.	HAPPAUGE, NY 11787
50157	N. L. INDUSTRIES, INC., ELECTRONICS DEPT.	P. O. BOX 787	MUSKEGON, MI 49443
56289	SPRAGUE ELECTRIC CO.	31 SOUTH ST.	NORTH ADAMS, MA 01247
63743	WARD LEONARD ELECTRIC CO., INC.		MOUNT VERNON, NY 10550
71400	BUSSMAN MFG., DIVISION OF MCGRAW- EDISON CO.	2536 W. UNIVERSITY ST.	ST. LOUIS, MO 63107
71590	CENTRALAB ELECTRONICS, DIV. OF GLOBE-UNION, INC.	5757 N. GREEN BAY AVE.	MILWAUKEE, WI 53201
72982	ERIE TECHNOLOGICAL PRODUCTS, INC.	644 W. 12TH ST.	ERIE, PA 16512
73138	BECKMAN INSTRUMENTS, INC., HELIPOT DIV.	2500 HARBOR BLVD.	FULLERTON, CA 92634
73445	AMPEREX ELECTRONIC CORP.	230 DUFFY AVE.	HICKSVILLE, L. I., NY 11802
75042	TRW ELECTRONIC COMPONENTS, IRC FIXED RESISTORS, PHILADELPHIA DIVISION	401 N. BROAD ST.	PHILADELPHIA, PA 19108
76493	BELL INDUSTRIES, INC., MILLER, J. W., DIV.	19070 REYES AVE.	COMPTON, CA 90224
78488	STACKPOLE CARBON CO.		ST. MARYS, PA 15857
80009	TEKTRONIX, INC.	P. O. BOX 500	BEAVERTON, OR 97077
80031	ELECTRA-MIDLAND CORP., MEPCO DIV., A NORTH AMERICAN PHILLIPS CO.	22 COLUMBIA RD.	MORRISTOWN, NJ 07960
80294	BOURNS, INC., INSTRUMENT DIV.	6135 MAGNOLIA AVE.	RIVERSIDE, CA 92506
80740	BECKMAN INSTRUMENTS, INC.	2500 HARBOR BLVD.	FULLERTON, CA 92634
81483	INTERNATIONAL RECTIFIER CORP.	9220 SUNSET BLVD.	LOS ANGELES, CA 90069
82389	SWITCHCRAFT, INC.	5555 N. ELSTON AVE.	CHICAGO, IL 60630
83003	VARO, INC.	800 W. GARLAND AVE.	GARLAND, TX 75040
90201	MALLORY CAPACITOR CO., DIV. OF P. R. MALLORY CO., INC.	3029 E. WASHINGTON ST.	INDIANAPOLIS, IN 46206
91637	DALE ELECTRONICS, INC.	P. O. BOX 609	COLUMBUS, NB 68601
93410	ESSEX INTERNATIONAL, INC., CONTROLS DIV. MANSFIELD PLANT	P. O. BOX 1007	MANSFIELD, OH 44903

Electrical Parts List—465 Service (SN B250000-up)

Ckt No.	Tektronix Part No.	Serial/Model No. Eff	Dscont	Name & Description	Mfr Code	Mfr Part Number
A1	670-2434-01			CKT BOARD ASSY:CH 1 ATTEN	80009	670-2434-01
A2	670-2434-01			CKT BOARD ASSY:CH 2 ATTEN	80009	670-2434-01
A3	670-2237-00			CKT BOARD ASSY:VERT PREAMP	80009	670-2237-00
A4	670-2236-00	B250000	B251724	CKT BOARD ASSY:VERT MODE	80009	670-2236-00
A4	670-2236-01	B251725		CKT BOARD ASSY:VERT MODE	80009	670-2236-01
A5	670-2238-00			CKT BOARD ASSY:VERT OUTPUT (IC)	80009	670-2238-00
A5	670-3023-02			CKT BOARD ASSY:VERT OUTPUT (DESCRETE)	80009	670-3023-02
A6	670-2245-00			CKT BOARD ASSY:FAN MOTOR	80009	670-2245-00
A7	670-3467-00			CKT BOARD ASSY:TIMING	80009	670-3467-00
A7 ¹	670-3467-01			CKT BOARD ASSY:TIMING	80009	670-3467-01
A8	670-2234-02	B250000	B251094	CKT BOARD ASSY:TRIG GEN AND SWP LOGIC	80009	670-2234-02
A8	670-2234-04	B251095		CKT BOARD ASSY:TRIG GEN AND SWP LOGIC	80009	670-2234-04
A9	670-2233-05			CKT BOARD ASSY:INTERFACE	80009	670-2233-05
A10	670-2279-00			CKT BOARD ASSY:GRATICULE ILLUM	80009	670-2279-00
B1690	147-0035-00			MOTOR,DC:BRUSHLESS,10-15VDC,145MA	25088	1AD3001-0A
C1	281-0064-00			CAP.,VAR,PLSTC:0.25-1.5PF,600V	72982	530-002
C2	281-0661-00			CAP.,FXD,CER DI:0.8PF(NOM VALUE),SEL	72982	301-000C0G0808B
C3	285-0816-01			CAP.,FXD,PLSTC:0.19UF,10%,600V	80009	285-0816-01
C6	283-0000-00			CAP.,FXD,CER DI:0.001UF,+100-0%,500V	72982	831-516E102P
C7	283-0000-00			CAP.,FXD,CER DI:0.001UF,+100-0%,500V	72982	831-516E102P
C10	307-1014-02			ATTENUATOR,FXD:100X	80009	307-1014-02
C11						
C12						
C13						
C12	307-1013-01			ATTENUATOR,FXD:10X	80009	307-1013-01
C13						
C16	283-0001-00			CAP.,FXD,CER DI:0.005UF,+100-0%,500V	72982	831-559E502P
C18	281-0626-00			CAP.,FXD,CER DI:3.3PF,1%,500V	72982	301-000C0J0339B
C21	283-0004-00			CAP.,FXD,CER DI:0.02UF,+80-20%,150V	72982	855016Z5V0203Z
C22	283-0087-00			CAP.,FXD,CER DI:300PF,10%,100V	72982	838-533B301K
C23	290-0517-00			CAP.,FXD,ELCTLT:6.8UF,20%,35V	56289	196D685X0035KA1
C25	283-0004-00			CAP.,FXD,CER DI:0.02UF,+80-20%,150V	72982	855016Z5V0203Z
C27	281-0207-00			CAP.,VAR,PLSTC:2-18PF,100V	80031	HT10EA-218
C33	281-0207-00			CAP.,VAR,PLSTC:2-18PF,100V	80031	HT10EA-218
C34	283-0139-00			CAP.,FXD,CER DI:150PF,20%,50V	72982	8101-050X5F151M
C36	283-0004-00			CAP.,FXD,CER DI:0.02UF,+80-20%,150V	72982	855016Z5V0203Z
C37	281-0536-00			CAP.,FXD,CER DI:1000PF,10%,500V	72982	301-055X5P0102K
C38	281-0536-00			CAP.,FXD,CER DI:1000PF,10%,500V	72982	301-055X5P0102K
C39	283-0004-00			CAP.,FXD,CER DI:0.02UF,+80-20%,150V	72982	855016Z5V0203Z
C42	283-0004-00			CAP.,FXD,CER DI:0.02UF,+80-20%,150V	72982	855016Z5V0203Z
C46	281-0626-00			CAP.,FXD,CER DI:3.3PF,1%,500V	72982	301-000C0J0339B
C47	281-0182-00			CAP.,VAR,PLSTC:1.8-10PF,300V	34553	2222-809-05002
C48	281-0182-00			CAP.,VAR,PLSTC:1.8-10PF,300V	34553	2222-809-05002
C49	281-0621-00			CAP.,FXD,CER DI:12PF,1%,500V	72982	301-000C0G0120F
C51	281-0064-00			CAP.,VAR,PLSTC:0.25-1.5PF,600V	72982	530-002
C52	281-0661-00			CAP.,FXD,CER DI:0.8PF(NOM VALUE),SEL	72982	301-000C0G0808B
C53	285-0816-01			CAP.,FXD,PLSTC:0.19UF,10%,600V	80009	285-0816-01
C56	283-0000-00			CAP.,FXD,CER DI:0.001UF,+100-0%,500V	72982	831-516E102P
C57	283-0000-00			CAP.,FXD,CER DI:0.001UF,+100-0%,500V	72982	831-516E102P
C60	307-1014-02			ATTENUATOR,FXD:100X	80009	307-1014-02
C61						
C62	307-1013-01			ATTENUATOR,FXD:10X	80009	307-1013-00
C63						
C66	283-0001-00			CAP.,FXD,CER DI:0.005UF,+100-0%,500V	72982	831-559E502P
C68	281-0626-00			CAP.,FXD,CER DI:3.3PF,1%,500V	72982	301-000C0J0339B
C71	283-0004-00			CAP.,FXD,CER DI:0.02UF,+80-20%,150V	72982	855016Z5V0203Z
C72	283-0087-00			CAP.,FXD,CER DI:300PF,10%,100V	72982	838-533B301K

¹DM43/DM40 only.

Electrical Parts List—465 Service (SN B250000-up)

Ckt No.	Tektronix Part No.	Serial/Model No. Eff	Dscont	Name & Description	Mfr Code	Mfr Part Number
C73	290-0517-00			CAP., FXD, ELCTLT:6.8UF, 20%, 35V	56289	196D685X0035KA1
C75	283-0004-00			CAP., FXD, CER DI:0.02UF, +80-20%, 150V	72982	855016Z5V0203Z
C77	281-0184-00			CAP., VAR, PLSTC:2-18PF, 500VDC	34553	2222-809-05003
C82	290-0517-00			CAP., FXD, ELCTLT:6.8UF, 20%, 35V	56289	196D685X0035KA1
C83	281-0207-00			CAP., VAR, PLSTC:2-18PF, 100V	80031	HT10EA-218
C84	283-0139-00			CAP., FXD, CER DI:150PF, 20%, 50V	72982	8101-050X5F151M
C87	281-0536-00			CAP., FXD, CER DI:1000PF, 10%, 500V	72982	301-055X5P0102K
C88	281-0536-00			CAP., FXD, CER DI:1000PF, 10%, 500V	72982	301-055X5P0102K
C92	283-0004-00			CAP., FXD, CER DI:0.02UF, +80-20%, 150V	72982	855016Z5V0203Z
C96	281-0626-00			CAP., FXD, CER DI:3.3PF, 1%, 500V	72982	301-000C0J0339B
C97	281-0182-00			CAP., VAR, PLSTC:1.8-10PF, 300V	34553	2222-809-05002
C98	281-0182-00			CAP., VAR, PLSTC:1.8-10PF, 300V	34553	2222-809-05002
C99	281-0621-00			CAP., FXD, CER DI:12PF, 1%, 500V	72982	301-000C0G0120F
C101	281-0628-00			CAP., FXD, CER DI:15PF, 5%, 600V	72982	301-000C0G0150G
C102	290-0517-00			CAP., FXD, ELCTLT:6.8UF, 20%, 35V	56289	196D685X0035KA1
C105	281-0207-00			CAP., VAR, PLSTC:2-18PF, 100V	80031	HT10EA-218
C107	281-0536-00			CAP., FXD, CER DI:1000PF, 10%, 500V	72982	301-055X5P0102K
C109	281-0536-00			CAP., FXD, CER DI:1000PF, 10%, 500V	72982	301-055X5P0102K
C122	281-0207-00			CAP., VAR, PLSTC:2-18PF, 100V	80031	HT10EA-218
C124	283-0004-00			CAP., FXD, CER DI:0.02UF, +80-20%, 150V	72982	855016Z5V0203Z
C125	290-0517-00			CAP., FXD, ELCTLT:6.8UF, 20%, 35V	56289	196D685X0035KA1
C135	281-0525-00			CAP., FXD, CER DI:470PF, +/-94PF, 500V	72982	301-000X5U0471M
C137	281-0525-00			CAP., FXD, CER DI:470PF, +/-94PF, 500V	72982	301-000X5U0471M
C142	283-0003-00			CAP., FXD, CER DI:0.01UF, +80-20%, 150V	72982	855-547E103Z
C144	281-0625-00			CAP., FXD, CER DI:35PF, 5%, 500V	72982	308-000C0G0350J
C149	281-0207-00			CAP., VAR, PLSTC:2-18PF, 100V	80031	HT10EA-218
C151	281-0525-00			CAP., FXD, CER DI:470PF, +/-94PF, 500V	72982	301-000X5U0471M
C161	290-0517-00			CAP., FXD, ELCTLT:6.8UF, 20%, 35V	56289	196D685X0035KA1
C162	281-0512-00			CAP., FXD, CER DI:27PF, +/-2.7PF, 500V	72982	308-000C0G0270K
C164	290-0517-00			CAP., FXD, ELCTLT:6.8UF, 20%, 35V	56289	196D685X0035KA1
C165	283-0004-00			CAP., FXD, CER DI:0.02UF, +80-20%, 150V	72982	855016Z5V0203Z
C201	281-0628-00			CAP., FXD, CER DI:15PF, 5%, 600V	72982	301-000C0G0150G
C202	283-0004-00			CAP., FXD, CER DI:0.02UF, +80-20%, 150V	72982	855016Z5V0203Z
C205	281-0207-00			CAP., VAR, PLSTC:2-18PF, 100V	80031	HT10EA-218
C207	281-0536-00			CAP., FXD, CER DI:1000PF, 10%, 500V	72982	301-055X5P0102K
C209	281-0536-00			CAP., FXD, CER DI:1000PF, 10%, 500V	72982	301-055X5P0102K
C225	283-0004-00			CAP., FXD, CER DI:0.02UF, +80-20%, 150V	72982	855016Z5V0203Z
C229	290-0517-00			CAP., FXD, ELCTLT:6.8UF, 20%, 35V	56289	196D685X0035KA1
C235	281-0525-00			CAP., FXD, CER DI:470PF, +/-94PF, 500V	72982	301-000X5U0471M
C237	281-0525-00			CAP., FXD, CER DI:470PF, +/-94PF, 500V	72982	301-000X5U0471M
C242	283-0003-00			CAP., FXD, CER DI:0.01UF, +80-20%, 150V	72982	855-547E103Z
C245	281-0628-00			CAP., FXD, CER DI:15PF, 5%, 600V	72982	301-000C0G0150G
C249	281-0207-00			CAP., VAR, PLSTC:2-18PF, 100V	80031	HT10EA-218
C251	281-0525-00			CAP., FXD, CER DI:470PF, +/-94PF, 500V	72982	301-000X5U0471M
C253	283-0000-00			CAP., FXD, CER DI:0.001UF, +100-0%, 500V	72982	831-516E102P
C261	290-0517-00			CAP., FXD, ELCTLT:6.8UF, 20%, 35V	56289	196D685X0035KA1
C262	281-0519-00			CAP., FXD, CER DI:47PF, +/-4.7PF, 500V	72982	308-000C0G0470K
C302	290-0517-00			CAP., FXD, ELCTLT:6.8UF, 20%, 35V	56289	196D685X0035KA1
C321	283-0004-00			CAP., FXD, CER DI:0.02UF, +80-20%, 150V	72982	855016Z5V0203Z
C334	283-0004-00			CAP., FXD, CER DI:0.02UF, +80-20%, 150V	72982	855016Z5V0203Z
C338	281-0579-00			CAP., FXD, CER DI:21PF, 5%, 500V	72982	301-050C0G0210J
C339	283-0644-00			CAP., FXD, MICA D:150PF, 1%, 500V	00853	D155E151F0
C346	290-0517-00			CAP., FXD, ELCTLT:6.8UF, 20%, 35V	56289	196D685X0035KA1

Electrical Parts List—465 Service (SN B250000-up)

Ckt No.	Tektronix Part No.	Serial/Model No. Eff Dscont	Name & Description	Mfr Code	Mfr Part Number
C347	281-0504-00		CAP.,FXD,CER DI:10PF,+/-1PF,500V	72982	301-000C0G0100F
C349	281-0578-00		CAP.,FXD,CER DI:18PF,5%,500V	72982	301-000C0G0180J
C351	281-0549-00		CAP.,FXD,CER DI:68PF,10%,500V	72982	301-000U2J0680K
C352	290-0517-00		CAP.,FXD,ELCTLT:6.8UF,20%,35V	56289	196D685X0035KA1
C354	283-0004-00		CAP.,FXD,CER DI:0.02UF,+80-20%,150V	72982	855016Z5V0203Z
C356	281-0549-00		CAP.,FXD,CER DI:68PF,10%,500V	72982	301-000U2J0680K
C358	290-0517-00		CAP.,FXD,ELCTLT:6.8UF,20%,35V	56289	196D685X0035KA1
C361	290-0517-00		CAP.,FXD,ELCTLT:6.8UF,20%,35V	56289	196D685X0035KA1
C362	290-0517-00		CAP.,FXD,ELCTLT:6.8UF,20%,35V	56289	196D685X0035KA1
C363	290-0517-00		CAP.,FXD,ELCTLT:6.8UF,20%,35V	56289	196D685X0035KA1
C364	281-0504-00		CAP.,FXD,CER DI:10PF,+/-1PF,500V	72982	301-000C0G0100F
C368	283-0058-00		CAP.,FXD,CER DI:0.027UF,10%,100V	72982	8131N147W5R273K
C374	281-0504-00		CAP.,FXD,CER DI:10PF,+/-1PF,500V	72982	301-000C0G0100F
C381	283-0000-00		CAP.,FXD,CER DI:0.001UF,+100-0%,500V	72982	831-516E102P
C391	283-0000-00		CAP.,FXD,CER DI:0.001UF,+100-0%,500V	72982	831-516E102P
C403	281-0089-00		CAP.,VAR,CER DI:2-8PF	72982	538-006-89A
C407	283-0081-00		CAP.,FXD,CER DI:0.1UF,+80-20%,25V	56289	36C600
C417	283-0081-00		CAP.,FXD,CER DI:0.1UF,+80-20%,25V	56289	36C600
C423	283-0180-00		CAP.,FXD,CER DI:5600PF,20%,200V	72982	8121N204651562M
C424	283-0198-00		CAP.,FXD,CER DI:0.22UF,20%,50V	72982	8131N075651224M
C433	283-0119-00		CAP.,FXD,CER DI:2200PF,5%,200V	72982	855-535B222J
C434	283-0341-00		CAP.,FXD,CER DI:0.047UF,10%,100V	72982	8131N145W5R473K
C441	283-0636-00		CAP.,FXD,MICA D:36PF,1.4%,100V	00853	D151E360D0
C442	281-0089-00		CAP.,VAR,CER DI:2-8PF	72982	538-006-89A
C443	281-0096-00		CAP.,VAR,AIR DI:5.5-18PF	72982	538-006D9-35
C444	281-0602-00		CAP.,FXD,CER DI:68PF,5%,500V	72982	308-000P2G0680J
C445	283-0660-00		CAP.,FXD,MICA D:510PF,2%,500V	00853	D155F511G0
C451	283-0144-00		CAP.,FXD,CER DI:33PF,1%,500V	72982	801-457P2G330F
C453	283-0000-00		CAP.,FXD,CER DI:0.001UF,+100-0%,500V	72982	831-516E102P
C457	283-0010-00		CAP.,FXD,CER DI:0.05UF,+100-20%,50V	56289	273C20
C458	283-0081-00		CAP.,FXD,CER DI:0.1UF,+80-20%,25V	56289	36C600
C459	283-0023-00		CAP.,FXD,CER DI:0.1UF,+80-20%,10V	56289	20C374
C464	283-0178-00		CAP.,FXD,CER DI:0.1UF,+80-20%,100V	72982	8131N145651104Z
C471	283-0178-00		CAP.,FXD,CER DI:0.1UF,+80-20%,100V	72982	8131N145651104Z
C502	281-0579-00		CAP.,FXD,CER DI:21PF,5%,500V	72982	301-050C0G0210J
C503	281-0651-00		CAP.,FXD,CER DI:47PF,5%,200V	72982	374-001T2H0470J
C511	281-0523-00		CAP.,FXD,CER DI:100PF,+/-20PF,350V	72982	301-000U2M0101M
C512	283-0004-00		CAP.,FXD,CER DI:0.02UF,+80-20%,150V	72982	855016Z5V0203Z
C515	281-0511-00		CAP.,FXD,CER DI:22PF,+/-2.2PF,500V	72982	301-000C0G0220K
C522	283-0003-00		CAP.,FXD,CER DI:0.01UF,+80-20%,150V	72982	855-547E103Z
C525	283-0003-00		CAP.,FXD,CER DI:0.01UF,+80-20%,150V	72982	855-547E103Z
C528	281-0511-00		CAP.,FXD,CER DI:22PF,+/-2.2PF,500V	72982	301-000C0G0220K
C531	283-0003-00		CAP.,FXD,CER DI:0.01UF,+80-20%,150V	72982	855-547E103Z
C549	283-0003-00		CAP.,FXD,CER DI:0.01UF,+80-20%,150V	72982	855-547E103Z
C601	283-0167-00		CAP.,FXD,CER DI:0.1UF,10%,100V	72982	8131N147W5R104K
C602	281-0611-00		CAP.,FXD,CER DI:2.7PF,+/-25PF,200V	72982	374-001C0J0279C
C603	281-0670-00		CAP.,FXD,CER DI:1.8PF,+/-0.1PF,500V	72982	374-005C0K0189B
C604	281-0523-00		CAP.,FXD,CER DI:100PF,+/-20PF,350V	72982	301-000U2M0101M
C606	281-0628-00		CAP.,FXD,CER DI:15PF,5%,600V	72982	301-000C0G0150G
C607	281-0515-00		CAP.,FXD,CER DI:27PF,+/-1.35PF,500V	72982	302-000C0G0270J
C611	281-0523-00		CAP.,FXD,CER DI:100PF,+/-20PF,350V	72982	301-000U2M0101M
C612	283-0004-00		CAP.,FXD,CER DI:0.02UF,+80-20%,150V	72982	855016Z5V0203Z
C615	281-0511-00		CAP.,FXD,CER DI:22PF,+/-2.2PF,500V	72982	301-000C0G0220K
C622	283-0003-00		CAP.,FXD,CER DI:0.01UF,+80-20%,150V	72982	855-547E103Z

Electrical Parts List—465 Service (SN B250000-up)

Ckt No.	Tektronix Part No.	Serial/Model No. Eff	Dscont	Name & Description	Mfr Code	Mfr Part Number
C625	283-0003-00			CAP.,FXD,CER DI:0.01UF,+80-20%,150V	72982	855-547E103Z
C628	281-0511-00			CAP.,FXD,CER DI:22PF,+/-2.2PF,500V	72982	301-000C0G0220K
C631	283-0003-00			CAP.,FXD,CER DI:0.01UF,+80-20%,150V	72982	855-547E103Z
C649	283-0003-00			CAP.,FXD,CER DI:0.01UF,+80-20%,150V	72982	855-547E103Z
C655	290-0527-00			CAP.,FXD,ELCTLT:15UF,20%,20V	90201	TDC156M020FL
C676	281-0540-00			CAP.,FXD,CER DI:51PF,5%,500V	72982	301-000U2J0510J
C678 ¹				CAP.,FXD,CER DI:33PF,(NOM VALUE),SEL		
C690	283-0024-00			CAP.,FXD,CER DI:0.1UF,+80-20%,30V	56289	273C16
C805	290-0527-00			CAP.,FXD,ELCTLT:15UF,20%,20V	90201	TDC156M020FL
C808	281-0577-00	B250000	B251094	CAP.,FXD,CER DI:14PF,5%,500V	72982	301-050C0G0140J
C808	281-0564-00	B251095		CAP.,FXD,CER DI:24PF,5%	72982	301-000C0G0240J
C824	281-0511-00			CAP.,FXD,CER DI:22PF,+/-2.2PF,500V	72982	301-000C0G0220K
C826	281-0523-00			CAP.,FXD,CER DI:100PF,+/-20PF,350V	72982	301-000U2M0101M
C829	290-0529-00			CAP.,FXD,ELCTLT:47UF,20%,20V	56289	196D476X0020LA3
C834	290-0527-00			CAP.,FXD,ELCTLT:15UF,20%,20V	90201	TDC156M020FL
C835	290-0527-00			CAP.,FXD,ELCTLT:15UF,20%,20V	90201	TDC156M020FL
C836	290-0527-00			CAP.,FXD,ELCTLT:15UF,20%,20V	90201	TDC156M020FL
C837	281-0524-00			CAP.,FXD,CER DI:150PF,+/-30PF,500V	72982	301-000X5U0151M
C839	290-0536-00			CAP.,FXD,ELCTLT:10UF,20%,25V	90201	TDC106M025FL
C853	283-0024-00			CAP.,FXD,CER DI:0.1UF,+80-20%,30V	56289	273C16
C855	290-0527-00			CAP.,FXD,ELCTLT:15UF,20%,20V	90201	TDC156M020FL
C858	281-0577-00	B250000	B251094	CAP.,FXD,CER DI:14PF,5%,500V	72982	301-050C0G0140J
C858	281-0564-00	B251095		CAP.,FXD,CER DI:24PF,5%,500V	72982	301-000C0G0240J
C863	281-0523-00			CAP.,FXD,CER DI:100PF,+/-20PF,350V	72982	301-000U2M0101M
C874	290-0527-00			CAP.,FXD,ELCTLT:15UF,20%,20V	90201	TDC156M020FL
C877	281-0508-00			CAP.,FXD,CER DI:12PF,+/-0.6PF,500V	72982	301-000C0G0120J
C879	290-0522-00			CAP.,FXD,ELCTLT:1UF,20%,50V	56289	196D105X0050HA1
C891	290-0527-00			CAP.,FXD,ELCTLT:15UF,20%,20V	90201	TDC156M020FL
C893	290-0527-00			CAP.,FXD,ELCTLT:15UF,20%,20V	90201	TDC156M020FL
C896	290-0527-00			CAP.,FXD,ELCTLT:15UF,20%,20V	90201	TDC156M020FL
C897	290-0527-00			CAP.,FXD,ELCTLT:15UF,20%,20V	90201	TDC156M020FL
C1000	283-0004-00			CAP.,FXD,CER DI:0.02UF,+80-20%,150V	72982	855016Z5V0203Z
C1002	283-0178-00			CAP.,FXD,CER DI:0.1UF,+80-20%,100V	72982	8131N145651104Z
C1003	281-0637-00			CAP.,FXD,CER DI:91PF,5%,500V	72982	301-000Z5D0910J
C1017	281-0511-00			CAP.,FXD,CER DI:22PF,+/-2.2PF,500V	72982	301-000C0G0220K
C1021	283-0004-00			CAP.,FXD,CER DI:0.02UF,+80-20%,150V	72982	855016Z5V0203Z
C1024	290-0527-00			CAP.,FXD,ELCTLT:15UF,20%,20V	90201	TDC156M020FL
C1026	281-0523-00			CAP.,FXD,CER DI:100PF,+/-20PF,350V	72982	301-000U2M0101M
C1031	283-0004-00			CAP.,FXD,CER DI:0.02UF,+80-20%,150V	72982	855016Z5V0203Z
C1036	281-0579-00			CAP.,FXD,CER DI:21PF,5%,500V	72982	301-050C0G0210J
C1038	290-0527-00			CAP.,FXD,ELCTLT:15UF,20%,20V	90201	TDC156M020FL
C1039	283-0023-00			CAP.,FXD,CER DI:0.1UF,+80-20%,10V	56289	20C374
C1044	290-0523-00			CAP.,FXD,ELCTLT:2.2UF,20%,20V	56289	196D225X0025HA1
C1062	283-0178-00			CAP.,FXD,CER DI:0.1UF,+80-20%,100V	72982	8131N145651104Z
C1063	281-0637-00			CAP.,FXD,CER DI:91PF,5%,500V	72982	301-000Z5D0910J
C1065	281-0629-00			CAP.,FXD,CER DI:33PF,5%,600V	72982	308-000C0G0330G
C1077	281-0511-00			CAP.,FXD,CER DI:22PF,+/-2.2PF,500V	72982	301-000C0G0220K
C1081	283-0004-00			CAP.,FXD,CER DI:0.02UF,+80-20%,150V	72982	855016Z5V0203Z
C1084	290-0527-00			CAP.,FXD,ELCTLT:15UF,20%,20V	90201	TDC156M020FL
C1086	281-0523-00			CAP.,FXD,CER DI:100PF,+/-20PF,350V	72982	301-000U2M0101M
C1091	283-0004-00			CAP.,FXD,CER DI:0.02UF,+80-20%,150V	72982	855016Z5V0203Z
C1096	281-0578-00			CAP.,FXD,CER DI:18PF,5%,500V	72982	301-000C0G0180J
C1099	283-0023-00			CAP.,FXD,CER DI:0.1UF,+80-20%,10V	56289	20C374
C1113	290-0519-00			CAP.,FXD,ELCTLT:100UF,20%,20V	56289	196D107X0020MA3
C1117	283-0080-00			CAP.,FXD,CER DI:0.022UF,+80-20%,25V	56289	19C611

¹Selected and added if necessary.

Electrical Parts List—465 Service (SN B250000-up)

Ckt No.	Tektronix Part No.	Serial/Model No. Eff	Dscont	Name & Description	Mfr Code	Mfr Part Number
C1130	281-0629-00			CAP.,FXD,CER DI:33PF,5%,600V	72982	30800COG0330G
C1131				CAP.,SET MTCHD:9.95UF		
C1133	295-0175-00			CAP.SET,MTCHD:0.1UF	80009	295-0175-00
C1135				CAP.,SET MTCHD:985PF		
C1136	281-0096-00			CAP.,VAR,AIR DI:5.5-18PF	72982	538-006D9-35
C1137	281-0089-00			CAP.,VAR,CER DI:2-8PF	72982	538-006-89A
C1138	283-0331-00			CAP.,FXD,CER DI:43PF,2%,100V	72982	805-505A430G
C1151	283-0268-00			CAP.,FXD,CER DI:0.015UF,10%,50V	72982	8131N075W5R153K
C1152	290-0245-00			CAP.,FXD,ELCTLT:1.5UF,10%,10V	56289	150D155X9010A2
C1153	283-0645-00			CAP.,FXD,MICA D:790PF,1%,100V	00853	D151E791F0
C1161	295-0157-00			CAP.,SET,MTCHD:1UF		
C1163				CAP.SET,MTCHD:0.1UF	80009	295-0157-00
C1165				CAP.,SET,MTCHD:998PF		
C1167	281-0089-00			CAP.,VAR,CER DI:2-8PF	72982	538-006-89A
C1168	283-0331-00			CAP.,FXD,CER DI:43PF,2%,100V	72982	805-505A430G
C1201	283-0023-00			CAP.,FXD,CER DI:0.1UF,+80-20%,10V	56289	20C374
C1208	283-0004-00			CAP.,FXD,CER DI:0.02UF,+80-20%,150V	72982	855016Z5V0203Z
C1209	283-0004-00			CAP.,FXD,CER DI:0.02UF,+80-20%,150V	72982	855016Z5V0203Z
C1220	290-0650-00			CAP.,FXD,ELCTLT:1000UF,20%,10V	56289	109D108X0010T2
C1235	283-0178-00			CAP.,FXD,CER DI:0.1UF,+80-20%,100V	72982	8131N145651104Z
C1249	283-0004-00			CAP.,FXD,CER DI:0.02UF,+80-20%,150V	72982	855016Z5V0203Z
C1256	283-0024-00			CAP.,FXD,CER DI:0.1UF,+80-20%,30V	56289	273C16
C1261	281-0064-00			CAP.,VAR,PLSTC:0.25-1.5PF,600V	72982	530-002
C1262	283-0092-00			CAP.,FXD,CER DI:0.03UF,+80-20%,200V	72982	845-534E303Z
C1263	283-0003-00			CAP.,FXD,CER DI:0.01UF,+80-20%,150V	72982	855-547E103Z
C1269	283-0003-00			CAP.,FXD,CER DI:0.01UF,+80-20%,150V	72982	855-547E103Z
C1281	281-0064-00			CAP.,VAR,PLSTC:0.25-1.5PF,600V	72982	530-002
C1282	283-0092-00			CAP.,FXD,CER DI:0.03UF,+80-20%,200V	72982	845-534E303Z
C1283	283-0003-00			CAP.,FXD,CER DI:0.01UF,+80-20%,150V	72982	855-547E103Z
C1288	283-0003-00			CAP.,FXD,CER DI:0.01UF,+80-20%,150V	72982	855-547E103Z
C1307	281-0611-00			CAP.,FXD,CER DI:2.7PF,+/-25PF,200V	72982	374-001C0J0279C
C1327	281-0611-00			CAP.,FXD,CER DI:2.7PF,+/-25PF,200V	72982	374-001C0J0279C
C1339	283-0081-00			CAP.,FXD,CER DI:0.1UF,+80-20%,25V	56289	36C600
C1348	283-0023-00			CAP.,FXD,CER DI:0.1UF,+80-20%,10V	56289	20C374
C1349	283-0023-00			CAP.,FXD,CER DI:0.1UF,+80-20%,10V	56289	20C374
C1403	283-0198-00			CAP.,FXD,CER DI:0.22UF,20%,50V	72982	8131N075651224M
C1404	290-0149-00			CAP.,FXD,ELCTLT:5UF,+75-10%,150V	56289	30D505G1500D4
C1412	290-0536-00			CAP.,FXD,ELCTLT:10UF,20%,25V	90201	TDC106M025FL
C1416	283-0203-00			CAP.,FXD,CER DI:0.47UF,20%,50V	72982	8131N075651474M
C1419	290-0560-00			CAP.,FXD,ELCTLT:47UF,20%,25V	56289	196D476X0025MA3
C1420	281-0622-00			CAP.,FXD,CER DI:47PF,1%,500V	72982	308-000COG0470F
C1421	283-0071-00			CAP.,FXD,CER DI:0.0068UF,+80-30%,5000V	56289	45C10A1
C1422	283-0071-00			CAP.,FXD,CER DI:0.0068UF,+80-30%,5000V	56289	45C10A1
C1423	283-0071-00			CAP.,FXD,CER DI:0.0068UF,+80-30%,5000V	56289	45C10A1
C1424	285-1040-00			CAP.,FXD,PLSTC:0.0012UF,10%,4000V	56289	430P122940
C1427	283-0002-00			CAP.,FXD,CER DI:0.01UF,+80-20%,500V	72982	811-546E103Z
C1430	285-1040-00			CAP.,FXD,PLSTC:0.0012UF,10%,4000V	56289	430P122940
C1442	283-0003-00			CAP.,FXD,CER DI:0.01UF,+80-20%,150V	72982	855-547E103Z
C1445	283-0003-00			CAP.,FXD,CER DI:0.01UF,+80-20%,150V	72982	855-547E103Z
C1447	283-0003-00			CAP.,FXD,CER DI:0.01UF,+80-20%,150V	72982	855-547E103Z
C1449	283-0003-00			CAP.,FXD,CER DI:0.01UF,+80-20%,150V	72982	855-547E103Z
C1452	281-0580-00			CAP.,FXD,CER DI:470PF,10%,500V	72982	301-000Z5D0471K

¹Individual timing capacitors in this assembly must be ordered by the 9 digit part number, letter suffix and tolerance printed on the timing capacitor to be replaced. The letter suffix and the tolerance should be the same for all of the timing capacitors in the assembly. EXAMPLE:

Electrical Parts List—465 Service (SN B250000-up)

Ckt No.	Tektronix Part No.	Serial/Model No. Eff Dscont	Name & Description	Mfr Code	Mfr Part Number
C1471	281-0064-00		CAP.,VAR,PLSTC:0.25-1.5PF,600V	72982	530-002
C1474	283-0111-00		CAP.,FXD,CER DI:0.1UF,20%,50V	72982	8131N075651104M
C1475	283-0000-00		CAP.,FXD,CER DI:0.001UF,+100-0%,500V	72982	831-516E102P
C1476	283-0057-00		CAP.,FXD,CER DI:0.1UF,+80-20%,200V	56289	274C10
C1477	283-0057-00		CAP.,FXD,CER DI:0.1UF,+80-20%,200V	56289	274C10
C1481	290-0164-00		CAP.,FXD,ELCTLT:1UF,+50-10%,150V	56289	30D105F150BA4
C1484	283-0178-00		CAP.,FXD,CER DI:0.1UF,+80-20%,100V	72982	8131N145651104Z
C1487	283-0101-00		CAP.,FXD,CER DI:4700PF,+80-20%,6000V	56289	45C11A
C1488	285-1040-00		CAP.,FXD,PLSTC:0.0012UF,10%,4000V	56289	430P122940
C1510	283-0167-00		CAP.,FXD,CER DI:0.1UF,10%,100V	72982	8131N147W5R104K
C1511	281-0580-00		CAP.,FXD,CER DI:470PF,10%,500V	72982	301-000Z5D0471K
C1512	290-0670-00		CAP.,FXD,ELCTLT:550UF,+75-10%,100V	56289	68D10512
C1513	290-0638-00		CAP.,FXD,ELCTLT:1200UF,+75-10%,100V	56289	68D10529
C1522	283-0004-00		CAP.,FXD,CER DI:0.02UF,+80-20%,150V	72982	855016Z5V0203Z
C1525	283-0178-00		CAP.,FXD,CER DI:0.1UF,+80-20%,100V	72982	8131N145651104Z
C1534	290-0305-00		CAP.,FXD,ELCTLT:3UF,20%,150V	56289	109D305X0150C2
C1537	281-0550-00		CAP.,FXD,CER DI:120PF,10%,500V	72982	301-000X5P0121K
C1542	290-0584-00		CAP.,FXD,ELCTLT:5500UF,+100-10%,30V	90201	20-36094
C1549	290-0529-00		CAP.,FXD,ELCTLT:47UF,20%,20V	56289	196D476X0020LA3
C1552	290-0571-00		CAP.,FXD,ELCTLT:5000UF,+100-0%,25V	90201	20-36043
C1559	290-0535-00		CAP.,FXD,ELCTLT:33UF,20%,10V	56289	196D336X0010KA1
C1562	290-0583-00		CAP.,FXD,ELCTLT:3000UF,+100-10%,35V	56289	68D10490
C1569	290-0535-00		CAP.,FXD,ELCTLT:33UF,20%,10V	56289	196D336X0010KA1
C1587	290-0523-00		CAP.,FXD,ELCTLT:2.2UF,20%,20V	56289	196D225X0025HA1
C1592	285-0686-00		CAP.,FXD,PLSTC:0.068UF,10%,100V	01002	64F22AA683
C1593	281-0551-00		CAP.,FXD,CER DI:390PF,10%,500V	72982	301-000X5P0391K
C1596	290-0532-00		CAP.,FXD,ELCTLT:150UF,20%,6V	90201	TDC157M006CL
C1597	281-0513-00		CAP.,FXD,CER DI:27PF,+/-5.4PF,500V	72982	301-000P2G0270M
C1698	290-0536-00		CAP.,FXD,ELCTLT:10UF,20%,25V	90201	TDC106M025FL
C4402	283-0032-00		CAP.,FXD,CER DI:470PF,5%,500V	72982	831-500Z5D471J
C4412	283-0032-00		CAP.,FXD,CER DI:470PF,5%,500V	72982	831-500Z5D471J
C4422	281-0139-00		CAP.,VAR,CER DI:2.5-9PF,100V	72982	518-002A2.5-9
C4425	281-0638-00		CAP.,FXD,CER DI:240PF,5%,500V	72982	301-000Z5D0241J
C4427	281-0524-00		CAP.,FXD,CER DI:150PF,+/-30PF,500V	72982	301-000X5U0151M
C4430	283-0000-00		CAP.,FXD,CER DI:0.001UF,+100-0%,500V	72982	831-516E102P
C4432	283-0065-00		CAP.,FXD,CER DI:0.001UF,5%,100V	72982	805-505B102J
C4437	281-0629-00		CAP.,FXD,CER DI:33PF,5%,600V	72982	308-000COG0330G
C4438	281-0123-00		CAP.,VAR,CER DI:5-25PF,100V	72982	518-000A5-25
C4439	281-0617-00		CAP.,FXD,CER DI:15PF,10%,200V	72982	374-001COG0150K
C4442	283-0065-00		CAP.,FXD,CER DI:0.001UF,5%,100V	72982	805-505B102J
C4444	281-0651-00		CAP.,FXD,CER DI:47PF,5%,200V	72982	374-001T2H0470J
C4464 ¹					
C4474 ¹					
C4481	283-0077-00		CAP.,FXD,CER DI:330PF,5%,500V	56289	40C94A3
C4482	283-0000-00		CAP.,FXD,CER DI:0.001UF,+100-0%,500V	72982	831-516E102P
C4485	283-0003-00		CAP.,FXD,CER DI:0.01UF,+80-20%,150V	72982	855-547E103Z
C4491	283-0077-00		CAP.,FXD,CER DI:330PF,5%,500V	56289	40C94A3
C4492	283-0000-00		CAP.,FXD,CER DI:0.001UF,+100-0%,500V	72982	831-516E102P
C4498	290-0523-00		CAP.,FXD,ELCTLT:2.2UF,20%,20V	56289	196D225X0025HA1
C4499	290-0523-00		CAP.,FXD,ELCTLT:2.2UF,20%,20V	56289	196D225X0025HA1
CR18	152-0323-00		SEMICONV DEVICE:SILICON,35V,100MA	03508	SE365
CR31	152-0153-00		SEMICONV DEVICE:SILICON,15V,50MA	13715	FD7003
CR32	152-0153-00		SEMICONV DEVICE:SILICON,15V,50MA	13715	FD7003
CR34	152-0271-00		SEMICONV DEVICE:SILICON,10PF	01281	V10E
CR39	152-0460-00		SEMICONV DEVICE:100V,1MA	04713	IN5298

¹Part of Circuit Board.

Electrical Parts List—465 Service (SN B250000-up)

Ckt No.	Tektronix Part No.	Serial/Model No. Eff	Dscont	Name & Description	Mfr Code	Mfr Part Number
CR68	152-0323-00			SEMICON D DEVICE: SILICON, 35V, 100MA	03508	SE365
CR81	152-0153-00			SEMICON D DEVICE: SILICON, 15V, 50MA	13715	FD7003
CR82	152-0153-00			SEMICON D DEVICE: SILICON, 15V, 50MA	13715	FD7003
CR84	152-0271-00			SEMICON D DEVICE: SILICON, 10PF	01281	V10E
CR152	152-0141-02			SEMICON D DEVICE: SILICON, 30V, 150MA	07910	1N4152
CR164	152-0141-02			SEMICON D DEVICE: SILICON, 30V, 150MA	07910	1N4152
CR165	152-0141-02			SEMICON D DEVICE: SILICON, 30V, 150MA	07910	1N4152
CR166	152-0141-02			SEMICON D DEVICE: SILICON, 30V, 150MA	07910	1N4152
CR167	152-0141-02			SEMICON D DEVICE: SILICON, 30V, 150MA	07910	1N4152
CR252	152-0141-02			SEMICON D DEVICE: SILICON, 30V, 150MA	07910	1N4152
CR304	152-0153-00			SEMICON D DEVICE: SILICON, 15V, 50MA	13715	FD7003
CR305	152-0153-00			SEMICON D DEVICE: SILICON, 15V, 50MA	13715	FD7003
CR307	152-0153-00			SEMICON D DEVICE: SILICON, 15V, 50MA	13715	FD7003
CR308	152-0153-00			SEMICON D DEVICE: SILICON, 15V, 50MA	13715	FD7003
CR314	152-0153-00			SEMICON D DEVICE: SILICON, 15V, 50MA	13715	FD7003
CR315	152-0153-00			SEMICON D DEVICE: SILICON, 15V, 50MA	13715	FD7003
CR317	152-0153-00			SEMICON D DEVICE: SILICON, 15V, 50MA	13715	FD7003
CR318	152-0153-00			SEMICON D DEVICE: SILICON, 15V, 50MA	13715	FD7003
CR342	152-0141-02			SEMICON D DEVICE: SILICON, 30V, 150MA	07910	1N4152
CR362	152-0141-02			SEMICON D DEVICE: SILICON, 30V, 150MA	07910	1N4152
CR368	152-0141-02			SEMICON D DEVICE: SILICON, 30V, 150MA	07910	1N4152
CR372	152-0141-02			SEMICON D DEVICE: SILICON, 30V, 150MA	07910	1N4152
CR378	152-0141-02			SEMICON D DEVICE: SILICON, 30V, 150MA	07910	1N4152
CR421	152-0269-00			SEMICON D DEVICE: SILICON, VAR VCAP., 4V, 33PF	25403	1N3182
CR422	152-0269-00			SEMICON D DEVICE: SILICON, VAR VCAP., 4V, 33PF	25403	1N3182
CR517	152-0246-00			SEMICON D DEVICE: SILICON, 400PIV, 200MA	07910	CD12676
CR550	152-0125-00	B250000	B256799	SEMICON D DEVICE: TUNNEL, 15PF, 4.7MA	03508	STD704
CR550	152-0125-01	B256800		SEMICON D DEVICE: TUNNEL, 15PF, 4.7MA		
CR552	152-0125-00	B256800	B256799	SEMICON D DEVICE: TUNNEL, 15PF, 4.7MA	03508	STD704
CR552	152-0125-01	B250000		SEMICON D DEVICE: TUNNEL, 15PF, 4.7MA		
CR553	152-0141-02			SEMICON D DEVICE: SILICON, 30V, 150MA	07910	1N4152
CR554	152-0141-02			SEMICON D DEVICE: SILICON, 30V, 150MA	07910	1N4152
CR617	152-0246-00			SEMICON D DEVICE: SILICON, 400PIV, 200MA	07910	CD12676
CR650	152-0125-00	B250000	B256799	SEMICON D DEVICE: TUNNEL, 15PF, 4.7MA	03508	STD704
CR650	152-0125-01	B256800		SEMICON D DEVICE: TUNNEL, 15PF, 4.7MA		
CR652	152-0125-00	B250000	B257699	SEMICON D DEVICE: TUNNEL, 15PF, 4.7MA	03508	STD704
CR652	152-0125-01	B256800		SEMICON D DEVICE: TUNNEL, 15PF, 4.7MA		
CR801	152-0322-00			SEMICON D DEVICE: SILICON, 15V	28480	5082-2672
CR809	152-0141-02			SEMICON D DEVICE: SILICON, 30V, 150MA	07910	1N4152
CR818	152-0141-02			SEMICON D DEVICE: SILICON, 30V, 150MA	07910	1N4152
CR822	152-0141-02			SEMICON D DEVICE: SILICON, 30V, 150MA	07910	1N4152
CR825	152-0141-02			SEMICON D DEVICE: SILICON, 30V, 150MA	07910	1N4152
CR826	152-0141-02			SEMICON D DEVICE: SILICON, 30V, 150MA	07910	1N4152
CR831	152-0141-02			SEMICON D DEVICE: SILICON, 30V, 150MA	07910	1N4152
CR832	152-0141-02			SEMICON D DEVICE: SILICON, 30V, 150MA	07910	1N4152
CR838	152-0141-02			SEMICON D DEVICE: SILICON, 30V, 150MA	07910	1N4152
CR851	152-0322-00			SEMICON D DEVICE: SILICON, 15V	28480	5082-2672
CR859	152-0141-02			SEMICON D DEVICE: SILICON, 30V, 150MA	07910	1N4152
CR862	152-0141-02			SEMICON D DEVICE: SILICON, 30V, 150MA	07910	1N4152
CR863	152-0141-02			SEMICON D DEVICE: SILICON, 30V, 150MA	07910	1N4152
CR877	152-0141-02			SEMICON D DEVICE: SILICON, 30V, 150MA	07910	1N4152
CR1001	152-0141-02			SEMICON D DEVICE: SILICON, 30V, 150MA	07910	1N4152
CR1004	152-0141-02			SEMICON D DEVICE: SILICON, 30V, 150MA	07910	1N4152
CR1011	152-0141-02			SEMICON D DEVICE: SILICON, 30V, 150MA	07910	1N4152
CR1024	152-0141-02			SEMICON D DEVICE: SILICON, 30V, 150MA	07910	1N4152
CR1035	152-0141-02			SEMICON D DEVICE: SILICON, 30V, 150MA	07910	1N4152
CR1042	152-0141-02			SEMICON D DEVICE: SILICON, 30V, 150MA	07910	1N4152

Electrical Parts List—465 Service (SN B250000-up)

Ckt No.	Tektronix Part No.	Serial/Model No. Eff	Dscont	Name & Description	Mfr Code	Mfr Part Number
CR1043	152-0141-02			SEMICON D DEVICE: SILICON, 30V, 150MA	07910	1N4152
CR1061	152-0141-02			SEMICON D DEVICE: SILICON, 30V, 150MA	07910	1N4152
CR1064	152-0141-02			SEMICON D DEVICE: SILICON, 30V, 150MA	07910	1N4152
CR1071	152-0141-02			SEMICON D DEVICE: SILICON, 30V, 150MA	07910	1N4152
CR1095	152-0141-02			SEMICON D DEVICE: SILICON, 30V, 150MA	07910	1N4152
CR1101	152-0141-02			SEMICON D DEVICE: SILICON, 30V, 150MA	07910	1N4152
CR1102	152-0141-02			SEMICON D DEVICE: SILICON, 30V, 150MA	07910	1N4152
CR1155	152-0333-00			SEMICON D DEVICE: SILICON, 55V, 200MA	80009	152-0333-00
CR1201	152-0141-02			SEMICON D DEVICE: SILICON, 30V, 150MA	07910	1N4152
CR1202	152-0141-02			SEMICON D DEVICE: SILICON, 30V, 150MA	07910	1N4152
CR1218	152-0141-02			SEMICON D DEVICE: SILICON, 30V, 150MA	07910	1N4152
CR1248	152-0141-02			SEMICON D DEVICE: SILICON, 30V, 150MA	07910	1N4152
CR1251	152-0153-00			SEMICON D DEVICE: SILICON, 15V, 50MA	13715	FD7003
CR1252	152-0153-00			SEMICON D DEVICE: SILICON, 15V, 50MA	13715	FD7003
CR1253	152-0322-00			SEMICON D DEVICE: SILICON, 15V	28480	5082-2672
CR1255	152-0141-02			SEMICON D DEVICE: SILICON, 30V, 150MA	07910	1N4152
CR1273	152-0322-00			SEMICON D DEVICE: SILICON, 15V	28480	5082-2672
CR1275	152-0141-02			SEMICON D DEVICE: SILICON, 30V, 150MA	07910	1N4152
CR1286	152-0141-02			SEMICON D DEVICE: SILICON, 30V, 150MA	07910	1N4152
CR1304	152-0141-02			SEMICON D DEVICE: SILICON, 30V, 150MA	07910	1N4152
CR1306	152-0141-02			SEMICON D DEVICE: SILICON, 30V, 150MA	07910	1N4152
CR1309	152-0141-02			SEMICON D DEVICE: SILICON, 30V, 150MA	07910	1N4152
CR1315	152-0141-02			SEMICON D DEVICE: SILICON, 30V, 150MA	07910	1N4152
CR1316	152-0141-02			SEMICON D DEVICE: SILICON, 30V, 150MA	07910	1N4152
CR1325	152-0141-02			SEMICON D DEVICE: SILICON, 30V, 150MA	07910	1N4152
CR1326	152-0141-02			SEMICON D DEVICE: SILICON, 30V, 150MA	07910	1N4152
CR1334	152-0141-02			SEMICON D DEVICE: SILICON, 30V, 150MA	07910	1N4152
CR1335	152-0141-02			SEMICON D DEVICE: SILICON, 30V, 150MA	07910	1N4152
CR1336	152-0141-02			SEMICON D DEVICE: SILICON, 30V, 150MA	07910	1N4152
CR1342	152-0141-02			SEMICON D DEVICE: SILICON, 30V, 150MA	07910	1N4152
CR1344	152-0141-02			SEMICON D DEVICE: SILICON, 30V, 150MA	07910	1N4152
CR1345	152-0141-02			SEMICON D DEVICE: SILICON, 30V, 150MA	07910	1N4152
CR1347	152-0141-02			SEMICON D DEVICE: SILICON, 30V, 150MA	07910	1N4152
CR1404	152-0333-00			SEMICON D DEVICE: SILICON, 55V, 200MA	80009	152-0333-00
CR1408	152-0141-02			SEMICON D DEVICE: SILICON, 30V, 150MA	07910	1N4152
CR1412	152-0141-02			SEMICON D DEVICE: SILICON, 30V, 150MA	07910	1N4152
CR1413	152-0141-02			SEMICON D DEVICE: SILICON, 30V, 150MA	07910	1N4152
CR1414	152-0141-02			SEMICON D DEVICE: SILICON, 30V, 150MA	07910	1N4152
CR1416	152-0333-00			SEMICON D DEVICE: SILICON, 55V, 200MA	80009	152-0333-00
CR1421	152-0409-00			SEMICON D DEVICE: SILICON, 1200V, 5MA	83003	VG-12X
CR1427	152-0107-00			SEMICON D DEVICE: SILICON, 375V, 400MA	80009	152-0107-00
CR1461	152-0141-02			SEMICON D DEVICE: SILICON, 30V, 150MA	07910	1N4152
CR1462	152-0141-02			SEMICON D DEVICE: SILICON, 30V, 150MA	07910	1N4152
CR1463	152-0141-02			SEMICON D DEVICE: SILICON, 30V, 150MA	07910	1N4152
CR1464	152-0153-00			SEMICON D DEVICE: SILICON, 15V, 50MA	13715	FD7003
CR1465	152-0141-02			SEMICON D DEVICE: SILICON, 30V, 150MA	07910	1N4152
CR1468	152-0141-02			SEMICON D DEVICE: SILICON, 30V, 150MA	07910	1N4152
CR1472	152-0061-00			SEMICON D DEVICE: SILICON, 175V, 100MA	80009	152-0061-00
CR1476	152-0107-00			SEMICON D DEVICE: SILICON, 375V, 400MA	80009	152-0107-00
CR1482	152-0061-00			SEMICON D DEVICE: SILICON, 175V, 100MA	80009	152-0061-00
CR1483	152-0061-00			SEMICON D DEVICE: SILICON, 175V, 100MA	80009	152-0061-00
CR1487	152-0242-00			SEMICON D DEVICE: SILICON, 225V, 200MA	12969	NDP341
CR1488	152-0242-00			SEMICON D DEVICE: SILICON, 225V, 200MA	12969	NDP341

Electrical Parts List—465 Service (SN B250000-up)

Ckt No.	Tektronix Part No.	Serial/Model No. Eff	Dscont	Name & Description	Mfr Code	Mfr Part Number
CR1511	152-0488-00			SEMICON D DEVICE:SILICON,200V,1500MA	14936	KBP02-8
CR1514	152-0107-00			SEMICON D DEVICE:SILICON,375V,400MA	80009	152-0107-00
CR1516	152-0107-00			SEMICON D DEVICE:SILICON,375V,400MA	80009	152-0107-00
CR1524	152-0141-02			SEMICON D DEVICE:SILICON,30V,150MA	07910	1N4152
CR1532	152-0061-00			SEMICON D DEVICE:SILICON,175V,100MA	80009	152-0061-00
CR1533	152-0141-02			SEMICON D DEVICE:SILICON,30V,150MA	07910	1N4152
CR1534	152-0066-00			SEMICON D DEVICE:SILICON,400V,750MA	02735	37304
CR1535	152-0066-00			SEMICON D DEVICE:SILICON,400V,750MA	02735	37304
CR1536	152-0141-02			SEMICON D DEVICE:SILICON,30V,150MA	07910	1N4152
CR1541	152-0556-00			SEMICON D DEVICE:BRIDGE,50V,2.5A	04713	MDA960-1
CR1549	152-0066-00			SEMICON D DEVICE:SILICON,400V,750MA	02735	37304
CR1551	152-0488-00			SEMICON D DEVICE:SILICON,200V,1500MA	14936	KBP02-8
CR1556	152-0141-02			SEMICON D DEVICE:SILICON,30V,150MA	07910	1N4152
CR1559	152-0066-00			SEMICON D DEVICE:SILICON,400V,750MA	02735	37304
CR1561	152-0488-00			SEMICON D DEVICE:SILICON,200V,1500MA	14936	KBP02-8
CR1564	152-0141-02			SEMICON D DEVICE:SILICON,30V,150MA	07910	1N4152
CR1569	152-0066-00			SEMICON D DEVICE:SILICON,400V,750MA	02735	37304
CR1596	152-0141-02			SEMICON D DEVICE:SILICON,30V,150MA	07910	1N4152
CR1691	152-0141-02			SEMICON D DEVICE:SILICON,30V,150MA	07910	1N4152
CR1692	152-0141-02			SEMICON D DEVICE:SILICON,30V,150MA	07910	1N4152
CR1694	152-0141-02			SEMICON D DEVICE:SILICON,30V,150MA	07910	1N4152
CR1696	152-0141-02			SEMICON D DEVICE:SILICON,30V,150MA	07910	1N4152
CR1699	152-0141-02			SEMICON D DEVICE:SILICON,30V,150MA	07910	1N4152
CR4434	152-0422-00			SEMICON D DEVICE:SILICON,4V,7PF	01281	PG1084
CR4451	152-0141-02			SEMICON D DEVICE:SILICON,30V,150MA	07910	1N4152
CR4452	152-0141-02			SEMICON D DEVICE:SILICON,30V,150MA	07910	1N4152
DL339	119-0387-00			DELAY LINE,ELEC:	80009	119-0387-00
DS382	150-0130-00			LAMP,INCAND:5V,60MA	08806	2200DX
DS386	150-0130-00			LAMP,INCAND:5V,60MA	08806	2200DX
DS388	150-0035-00			LAMP,GLOW:90V,0.3MA	08806	ALD-T
DS389	150-0035-00			LAMP,GLOW:90V,0.3MA	08806	ALD-T
DS392	150-0130-00			LAMP,INCAND:5V,60MA	08806	2200DX
DS396	150-0130-00			LAMP,INCAND:5V,60MA	08806	2200DX
DS834	150-0130-00			LAMP,INCAND:5V,60MA	08806	2200DX
DS836	150-0130-00			LAMP,INCAND:5V,60MA	08806	2200DX
DS1140	150-0035-00			LAMP,GLOW:90V,0.3MA	08806	ALD-T
DS1239	150-0035-00			LAMP,GLOW:90V,0.3MA	08806	ALD-T
DS1425	150-0002-00			LAMP,GLOW:0.5 MA 60/125V	08806	NE2T-ALAT
DS1426	150-0002-00			LAMP,GLOW:0.5 MA 60/125V	08806	NE2T-ALAT
DS1570	150-0129-00			LAMP,INCAND:6.3V,200MA	08806	2112D
DS1571	150-0129-00			LAMP,INCAND:6.3V,200MA	08806	2112D
DS1588	150-0130-00			LAMP,INCAND:5V,60MA	08806	2200DX
F1419	159-0016-00			FUSE,CARTRIDGE:3AG,1.5A,250V,FAST-BLOW	71400	AGC1 1-2
F1501	159-0016-00			FUSE,CARTRIDGE:3AG,1.5A,250V,FAST-BLOW	71400	AGC1 1-2
F1501 ¹	159-0042-00			FUSE,CARTRIDGE:0.75A,250V,FAST-BLOW		
J1	136-0499-14			CONNECTOR,RCPT,:14 CONTACT	00779	4-380949-4
J2	136-0499-10			CONNECTOR,RCPT,:10 CONTACT	00779	4-380949-0
J3	136-0499-04			CONNECTOR,RCPT,:4 CONTACT	00779	3-380949-4
J4	131-0679-02			CONNECTOR,RCPT,:BNC W/HARDWARE	80009	131-0679-02
J5	136-0499-10			CONNECTOR,RCPT,:10 CONTACT	00779	4-380949-0
J6	136-0499-14			CONNECTOR,RCPT,:14 CONTACT	00779	4-380949-4
J54	131-0679-02			CONNECTOR,RCPT,:BNC W/HARDWARE	80009	131-0679-02

¹For 230V Operation.

Electrical Parts List—465 Service (SN B250000-up)

Ckt No.	Tektronix Part No.	Serial/Model No. Eff	Dscont	Name & Description	Mfr Code	Mfr Part Number
J162	131-1003-00			CONNECTOR BODY, :CKT BD MT, 3 PRONG	80009	131-1003-00
J164	131-1003-00			CONNECTOR BODY, :CKT BD MT, 3 PRONG	80009	131-1003-00
J165	131-0955-00			CONNECTOR, RCPT, :BNC, FEMALE	24931	28JR200-1
J168	131-1003-00			CONNECTOR BODY, :CKT BD MT, 3 PRONG	80009	131-1003-00
J262	131-1003-00			CONNECTOR BODY, :CKT BD MT, 3 PRONG	80009	131-1003-00
J338	131-1003-00			CONNECTOR BODY, :CKT BD MT, 3 PRONG	80009	131-1003-00
J339	131-1003-00			CONNECTOR BODY, :CKT BD MT, 3 PRONG	80009	131-1003-00
J349	131-1003-00			CONNECTOR BODY, :CKT BD MT, 3 PRONG	80009	131-1003-00
J351	131-1003-00			CONNECTOR BODY, :CKT BD MT, 3 PRONG	80009	131-1003-00
J359	131-1003-00			CONNECTOR BODY, :CKT BD MT, 3 PRONG	80009	131-1003-00
J500	131-0955-00			CONNECTOR, RCPT, :BNC, FEMALE	24931	28JR200-1
J571	131-1003-00			CONNECTOR BODY, :CKT BD MT, 3 PRONG	80009	131-1003-00
J573	131-1003-00			CONNECTOR BODY, :CKT BD MT, 3 PRONG	80009	131-1003-00
J575	131-1003-00			CONNECTOR BODY, :CKT BD MT, 3 PRONG	80009	131-1003-00
J600	131-0955-00			CONNECTOR, RCPT, :BNC, FEMALE	24931	28JR200-1
J678	131-1003-00			CONNECTOR BODY, :CKT BD MT, 3 PRONG	80009	131-1003-00
J688	131-1003-00			CONNECTOR BODY, :CKT BD MT, 3 PRONG	80009	131-1003-00
J1317	131-1003-00			CONNECTOR BODY, :CKT BD MT, 3 PRONG	80009	131-1003-00
J1318	131-0955-00			CONNECTOR, RCPT, :BNC, FEMALE	24931	28JR200-1
J1319	131-1003-00			CONNECTOR BODY, :CKT BD MT, 3 PRONG	80009	131-1003-00
J1337	131-1003-00			CONNECTOR BODY, :CKT BD MT, 3 PRONG	80009	131-1003-00
J1338	131-0955-00			CONNECTOR, RCPT, :BNC, FEMALE	24931	28JR200-1
J1450	131-0955-00			CONNECTOR, RCPT, :BNC, FEMALE	24931	28JR200-1
L122	108-0181-01			COIL, RF:0.2UH	80009	108-0181-01
L149	108-0181-01			COIL, RF:0.2UH	80009	108-0181-01
L249	108-0181-01			COIL, RF:0.2UH	80009	108-0181-01
L338	108-0182-00			COIL, RF:0.3UH	80009	108-0182-00
L339	108-0182-00			COIL, RF:0.3UH	80009	108-0182-00
L440	108-0370-00			COIL, RF:0.14UH	80009	108-0370-00
L442	108-0370-00			COIL, RF:0.14UH	80009	108-0370-00
L461	108-0740-00			COIL, RF:225NH	80009	108-0740-00
L471	108-0740-00			COIL, RF:225NH	80009	108-0740-00
L507	108-0655-00			COIL, RF:75NH	80009	108-0655-00
L546	108-0370-00			COIL, RF:0.14UH	80009	108-0370-00
L547	108-0370-00			COIL, RF:0.14UH	80009	108-0370-00
L646	108-0370-00			COIL, RF:0.14UH	80009	108-0370-00
L647	108-0370-00			COIL, RF:0.14UH	80009	108-0370-00
L874	108-0538-00			COIL, RF:2.7UH	76493	70F276A1
L891	108-0538-00			COIL, RF:2.7UH	76493	70F276A1
L893	108-0538-00			COIL, RF:2.7UH	76493	70F276A1
L897	108-0538-00			COIL, RF:2.7UH	76493	70F276A1
L1006	108-0328-00			COIL, RF:0.3UH	80009	108-0328-00
L1419	108-0422-00			COIL, RF:80UH	80009	108-0422-00
L1440	108-0713-00			COIL, TUBE DEFLE:TRACE ROTATION	80009	108-0713-00
L1446	108-0714-00			COIL, TUBE DEFLE:Y AXIS ALIGNMENT	80009	108-0714-00
L1596	108-0245-00			COIL, RF:3.9UH	80009	108-0245-00
L4402 ¹	276-0507-00			SHIELDING BEAD, :0.6UH	78488	57-0180-7D
L4464	108-0570-00			TRANSFORMER, RF:	80009	108-0570-00
L4474	108-0570-00			TRANSFORMER, RF:	80009	108-0570-00
L4498	108-0440-00			COIL, RF:8UH, TOROIDAL INDUCTOR	80009	108-0440-00
L4499	108-0440-00			COIL, RF:8UH, TOROIDAL INDUCTOR	80009	108-0440-00
LR461	108-0284-00			COIL, RF:0.1UH	80009	108-0284-00
LR471	108-0284-00			COIL, RF:0.1UH	80009	108-0284-00

¹Added if necessary.

Electrical Parts List—465 Service (SN B250000-up)

Ckt No.	Tektronix Part No.	Serial/Model No. Eff	Dscont	Name & Description	Mfr Code	Mfr Part Number
LR4483	108-0328-00			COIL, RF : 0.3UH	80009	108-0328-00
LR4493	108-0328-00			COIL, RF : 0.3UH	80009	108-0328-00
Q20A, B	151-1032-00			TRANSISTOR: SILICON, FET, DUAL	17856	DN399
Q32	151-0259-00			TRANSISTOR: SILICON, NPN	07910	CS23214
Q36	151-0259-00			TRANSISTOR: SILICON, NPN	07910	CS23214
Q42	151-0221-00			TRANSISTOR: SILICON, PNP	07263	S24849
Q44	151-0221-00			TRANSISTOR: SILICON, PNP	07263	S24849
Q70A, B	151-1032-00			TRANSISTOR: SILICON, FET, DUAL	17856	DN399
Q82	151-0259-00			TRANSISTOR: SILICON, NPN	07910	CS23214
Q86	151-0259-00			TRANSISTOR: SILICON, NPN	07910	CS23214
Q92	151-0221-00			TRANSISTOR: SILICON, PNP	07263	S24849
Q94	151-0221-00			TRANSISTOR: SILICON, PNP	07263	S24849
Q102	151-0427-00			TRANSISTOR: SILICON, NPN	80009	151-0427-00
Q104	151-0427-00			TRANSISTOR: SILICON, NPN	80009	151-0427-00
Q122	151-0198-00			TRANSISTOR: SILICON, NPN, SEL FROM MPS918	80009	151-0198-00
Q124	151-0198-00			TRANSISTOR: SILICON, NPN, SEL FROM MPS918	80009	151-0198-00
Q132 } ¹	153-0609-00			SEMICON DVC SE: SILICON, PNP	80009	153-0609-00
Q134 }						
Q142	151-0271-00			TRANSISTOR: SILICON, PNP	01295	SKA4504
Q148	151-0271-00			TRANSISTOR: SILICON, PNP	01295	SKA4504
Q152	151-0221-00			TRANSISTOR: SILICON, PNP	07263	S24849
Q162	151-0221-00			TRANSISTOR: SILICON, PNP	07263	S24849
Q164	151-0221-00			TRANSISTOR: SILICON, PNP	07263	S24849
Q168	151-0190-00			TRANSISTOR: SILICON, NPN	04713	2N3904
Q202	151-0427-00			TRANSISTOR: SILICON, NPN	80009	151-0427-00
Q204	151-0427-00			TRANSISTOR: SILICON, NPN	80009	151-0427-00
Q222 }	153-0547-00			SEMICON DVC SE: SILICON, NPN, MATCHED	80009	153-0547-00
Q224 }						
Q226 }	153-0547-00			SEMICON DVC SE: SILICON, NPN, MATCHED	80009	153-0547-00
Q228 }						
Q232 } ²	153-0609-00			SEMICON DVC SE: SILICON, PNP	80009	153-0609-00
Q234 }						
Q242	151-0271-00			TRANSISTOR: SILICON, PNP	01295	SKA4504
Q248	151-0271-00			TRANSISTOR: SILICON, PNP	01295	SKA4504
Q252	151-0221-00			TRANSISTOR: SILICON, PNP	07263	S24849
Q262	151-0221-00			TRANSISTOR: SILICON, PNP	07263	S24849
Q304	151-0221-00			TRANSISTOR: SILICON, PNP	07263	S24849
Q308	151-0221-00			TRANSISTOR: SILICON, PNP	07263	S24849
Q314	151-0221-00			TRANSISTOR: SILICON, PNP	07263	S24849
Q318	151-0221-00			TRANSISTOR: SILICON, PNP	07263	S24849
Q322	151-0269-00	B250000	B255714	TRANSISTOR: SILICON, NPN, SEL FROM SE3005	80009	151-0269-00
Q322	151-0471-00	B255715		TRANSISTOR: SILICON, NPN		
Q324	151-0269-00	B250000	B255714	TRANSISTOR: SILICON, NPN, SEL FROM SE3005	80009	151-0269-00
Q324	151-0471-00	B255715		TRANSISTOR: SILICON, NPN		
Q332	151-0188-00			TRANSISTOR: SILICON, PNP	04713	2N3906
Q344	151-0367-00			TRANSISTOR: SILICON, NPN, SEL FROM 3571TP	80009	151-0367-00
Q346	151-0221-00			TRANSISTOR: SILICON, PNP	07263	S24849
Q352	151-0223-00			TRANSISTOR: SILICON, NPN	80009	151-0223-00
Q358	151-0223-00			TRANSISTOR: SILICON, NPN	80009	151-0223-00
Q364	151-0190-00			TRANSISTOR: SILICON, NPN	04713	2N3904
Q374	151-0190-00			TRANSISTOR: SILICON, NPN	04713	2N3904
Q382	151-0435-00			TRANSISTOR: SILICON, PNP	04713	MPS-A65
Q386	151-0301-00			TRANSISTOR: SILICON, PNP	04713	2N2907A
Q392	151-0435-00			TRANSISTOR: SILICON, PNP		

¹Q132 and Q134 furnished as a matched pair.

²Q232 and Q234 furnished as a matched pair.

Electrical Parts List—465 Service (SN B250000-up)

Ckt No.	Tektronix Part No.	Serial/Model No. Eff	Dscont	Name & Description	Mfr Code	Mfr Part Number
Q396	151-0301-00			TRANSISTOR:SILICON,PNP	04713	2N2907A
Q522	151-1042-00			SEMICON DVC SE:MATCHED PAIR FET	80009	151-1042-00
Q524						
Q550	151-0221-00			TRANSISTOR:SILICON,PNP	07263	S24849
Q552	151-0221-00			TRANSISTOR:SILICON,PNP	07263	S24849
Q622	151-1042-00			SEMICON DVC SE:MATCHED PAIR FET	80009	151-1042-00
Q624						
Q650	151-0221-00			TRANSISTOR:SILICON,PNP	07263	S24849
Q652	151-0221-00			TRANSISTOR:SILICON,PNP	07263	S24849
Q672 ¹	153-0597-00			SEMICON DVC SE:SILICON,PNP	80009	153-0597-00
Q678	151-0367-00			TRANSISTOR:SILICON,NPN,SEL FROM 3571TP	80009	151-0367-00
Q682 ¹	153-0597-00			SEMICON DVC SE:SILICON,PNP	80009	153-0597-00
Q688	151-0367-00			TRANSISTOR:SILICON,NPN,SEL FROM 3571TP	80009	151-0367-00
Q804	151-0220-03	B250000	B251094	TRANSISTOR:SILICON,PNP	80009	151-0220-03
Q804	151-0199-00	B251095		TRANSISTOR:SILICON,PNP	04713	MPS3640
Q812	151-0220-03			TRANSISTOR:SILICON,PNP	80009	151-0220-03
Q814	151-0220-03			TRANSISTOR:SILICON,PNP	80009	151-0220-03
Q822	151-0220-03			TRANSISTOR:SILICON,PNP	80009	151-0220-03
Q824	151-0220-03			TRANSISTOR:SILICON,PNP	80009	151-0220-03
Q828	151-0190-00			TRANSISTOR:SILICON,NPN	04713	2N3904
Q854	151-0220-03	B250000	B251094	TRANSISTOR:SILICON,PNP	80009	151-0220-03
Q854	151-0199-00	B251095		TRANSISTOR:SILICON,PNP	04713	MPS3640
Q862	151-0220-03			TRANSISTOR:SILICON,PNP	80009	151-0220-03
Q864	151-0220-03			TRANSISTOR:SILICON,PNP	80009	151-0220-03
Q1002A,B	151-0354-00			TRANSISTOR:SILICON,PNP,DUAL	32293	ITS1200A
Q1012	151-0220-03			TRANSISTOR:SILICON,PNP	80009	151-0220-03
Q1014	151-0220-03			TRANSISTOR:SILICON,PNP	80009	151-0220-03
Q1024	151-0283-00			TRANSISTOR:SILICON,NPN	07263	S032790
Q1030	151-1025-00			TRANSISTOR:SILICON,JFE,N-CHANNEL	01295	SBA8129
Q1036	151-0127-00			TRANSISTOR:SILICON,NPN	07263	S6075
Q1038	151-0188-00			TRANSISTOR:SILICON,PNP	04713	2N3906
Q1042A,B	151-0232-00			TRANSISTOR:SILICON,NPN,DUAL	12040	NS7348
Q1044	151-0190-00			TRANSISTOR:SILICON,NPN	04713	2N3904
Q1052	151-0220-03			TRANSISTOR:SILICON,PNP	80009	151-0220-03
Q1054	151-0220-03			TRANSISTOR:SILICON,PNP	80009	151-0220-03
Q1062A,B	151-0354-00			TRANSISTOR:SILICON,PNP,DUAL	32293	ITS1200A
Q1063	151-0188-00			TRANSISTOR:SILICON,PNP	04713	2N3906
Q1072	151-0220-03			TRANSISTOR:SILICON,PNP	80009	151-0220-03
Q1074	151-0220-03			TRANSISTOR:SILICON,PNP	80009	151-0220-03
Q1084	151-0283-00			TRANSISTOR:SILICON,NPN	07263	S032790
Q1090	151-1025-00			TRANSISTOR:SILICON,JFE,N-CHANNEL	01295	SBA8129
Q1096	151-0127-00			TRANSISTOR:SILICON,NPN	07263	S6075
Q1098	151-0188-00			TRANSISTOR:SILICON,PNP	04713	2N3906
Q1140	151-0302-00			TRANSISTOR:SILICON,NPN	04713	2N2222A
Q1170	151-0302-00			TRANSISTOR:SILICON,NPN	04713	2N2222A
Q1214	151-0220-03			TRANSISTOR:SILICON,PNP	80009	151-0220-03
Q1218	151-0216-00			TRANSISTOR:SILICON,PNP	04713	MPS6523
Q1224	151-0190-02			TRANSISTOR:SILICON,NPN	04713	2N3904
Q1226	151-0188-00			TRANSISTOR:SILICON,PNP	04713	2N3906
Q1234	151-0190-02			TRANSISTOR:SILICON,NPN	04713	2N3904
Q1236	151-0188-00			TRANSISTOR:SILICON,PNP	04713	2N3906
Q1244	151-0190-00			TRANSISTOR:SILICON,NPN	04713	2N3904
Q1254	151-0301-00			TRANSISTOR:SILICON,PNP	04713	2N2907A
Q1262	151-0406-00			TRANSISTOR:SILICON,PNP	07263	S37880
Q1266	151-0407-00			TRANSISTOR:SILICON,NPN	07263	S37881

¹Q672 and Q682 furnished as a matched pair.

Electrical Parts List—465 Service (SN B250000-up)

Ckt No.	Tektronix Part No.	Serial/Model No. Eff Dscont	Name & Description	Mfr Code	Mfr Part Number
Q1274	151-0302-00		TRANSISTOR:SILICON,NPN	04713	2N2222A
Q1282	151-0406-00		TRANSISTOR:SILICON,PNP	07263	S37880
Q1286	151-0407-00		TRANSISTOR:SILICON,NPN	07263	S37881
Q1304	151-0190-00		TRANSISTOR:SILICON,NPN	04713	2N3904
Q1306	151-0190-00		TRANSISTOR:SILICON,NPN	04713	2N3904
Q1314	151-0220-03		TRANSISTOR:SILICON,PNP	80009	151-0220-03
Q1324	151-0190-00		TRANSISTOR:SILICON,NPN	04713	2N3904
Q1326	151-0190-00		TRANSISTOR:SILICON,NPN	04713	2N3904
Q1334	151-0220-03		TRANSISTOR:SILICON,PNP	80009	151-0220-03
Q1404	151-0126-00		TRANSISTOR:SILICON,NPN	07263	2N2484
Q1408	151-0301-00		TRANSISTOR:SILICON,PNP	04713	2N2907A
Q1413	151-0188-00		TRANSISTOR:SILICON,PNP	04713	2N3906
Q1414	151-0190-00		TRANSISTOR:SILICON,NPN	04713	2N3904
Q1416	151-0136-00		TRANSISTOR:SILICON,NPN	02735	35495
Q1418	151-0140-00		TRANSISTOR:SILICON,NPN	02735	36568
Q1466	151-0223-00		TRANSISTOR:SILICON,NPN	80009	151-0223-00
Q1472	151-0188-00		TRANSISTOR:SILICON,PNP	04713	2N3906
Q1474	151-0407-00		TRANSISTOR:SILICON,NPN	07263	S37881
Q1478	151-0406-00		TRANSISTOR:SILICON,PNP	07263	S37880
Q1516	151-0311-01		TRANSISTOR:SILICON,NPN	04713	MJE340
Q1518	151-0347-00		TRANSISTOR:SILICON,NPN	80009	151-0347-00
Q1532	151-0347-00		TRANSISTOR:SILICON,NPN	80009	151-0347-00
Q1534	151-0436-00		TRANSISTOR:SILICON,NPN	80009	151-0436-00
Q1536	151-0347-00		TRANSISTOR:SILICON,NPN	80009	151-0347-00
Q1544	151-0302-00		TRANSISTOR:SILICON,NPN	04713	2N2222A
Q1546	151-0349-00		TRANSISTOR:SILICON,NPN SEL FROM MJE2801	04713	SJE924
Q1548	151-0302-00		TRANSISTOR:SILICON,NPN	04713	2N2222A
Q1556	151-0390-00		TRANSISTOR:SILICON,NPN	04713	MPS-U45
Q1558	151-0302-00		TRANSISTOR:SILICON,NPN	04713	2N2222A
Q1564	151-0302-00		TRANSISTOR:SILICON,NPN	04713	2N2222A
Q1566	151-0349-00		TRANSISTOR:SILICON,NPN SEL FROM MJE2801	04713	SJE924
Q1568	151-0302-00		TRANSISTOR:SILICON,NPN	04713	2N2222A
Q1570	151-0390-00		TRANSISTOR:SILICON,NPN	04713	MPS-U45
Q1582	151-0302-00		TRANSISTOR:SILICON,NPN	04713	2N2222A
Q1588	151-0302-00		TRANSISTOR:SILICON,NPN	04713	2N2222A
Q1590	151-0342-00		TRANSISTOR:SILICON,PNP	07263	2N4249
Q1594	151-0342-00		TRANSISTOR:SILICON,PNP	07263	2N4249
Q1598	151-0164-00		TRANSISTOR:SILICON,PNP	01295	SKB3334
Q1698	151-0301-00		TRANSISTOR:SILICON,PNP	04713	2N2907A
Q4402	151-0212-00		TRANSISTOR:SILICON,NPN	73445	A485
Q4406	151-0212-00		TRANSISTOR:SILICON,NPN	73445	A485
Q4412	151-0212-00		TRANSISTOR:SILICON,NPN	73445	A485
Q4416	151-0212-00		TRANSISTOR:SILICON,NPN	73445	A485
Q4432	151-0212-00		TRANSISTOR:SILICON,NPN	73445	A485
Q4442	151-0212-00		TRANSISTOR:SILICON,NPN	73445	A485
Q4462	151-0434-00		TRANSISTOR:SILICON,PNP	04713	2N4261
Q4468	151-0448-00		TRANSISTOR:SILICON,NPN	80009	151-0448-00
Q4472	151-0434-00		TRANSISTOR:SILICON,PNP	04713	2N4261
Q4478	151-0448-00		TRANSISTOR:SILICON,NPN	80009	151-0448-00
Q4482	151-0446-00		TRANSISTOR:SILICON,NPN,SE	80009	151-0446-00
Q4492	151-0446-00		TRANSISTOR:SILICON,NPN,SE	80009	151-0446-00
R1	315-0510-00		RES.,FXD,COMP:51 OHM,5%,0.25W	01121	CB5105

Electrical Parts List—465 Service (SN B250000-up)

Ckt No.	Tektronix Part No.	Serial/Model No. Eff	Dscont	Name & Description	Mfr Code	Mfr Part Number
R3	317-0047-00			RES.,FXD,COMP:4.7 OHM,5%,0.125W	01121	BB4R705
R4	316-0105-00			RES.,FXD,COMP:1M OHM,10%,0.25W	01121	CB1051
R6	317-0101-00			RES.,FXD,COMP:100 OHM,5%,0.125W	01121	BB1015
R15	321-0481-00			RES.,FXD,FILM:1M OHM,1%,0.125W	75042	CEAT0-1004F
R16	316-0474-00			RES.,FXD,COMP:470K OHM,10%,0.25W	01121	CB4741
R18	315-0361-00			RES.,FXD,COMP:360 OHM,5%,0.25W	01121	CB3615
R21	315-0470-00			RES.,FXD,COMP:47 OHM,5%,0.25W	01121	CB4705
R22	321-0030-02			RES.,FXD,FILM:20 OHM,0.5%,0.125W	75042	CEAT2-20R00D
R23	321-0030-02			RES.,FXD,FILM:20 OHM,0.5%,0.125W	75042	CEAT2-20R00D
R25	311-1227-00			RES.,VAR,NONWIR:5K OHM,20%,0.50W	80294	3389F-P31-502
R26	315-0123-00			RES.,FXD,COMP:12K OHM,5%,0.25W	01121	CB1235
R27	315-0151-00			RES.,FXD,COMP:150 OHM,5%,0.25W	01121	CB1515
R32	321-0208-00			RES.,FXD,FILM:1.43K OHM,1%,0.125W	75042	CEAT0-1431F
R33	321-0097-00			RES.,FXD,FILM:100 OHM,1%,0.125W	75042	CEAT0-1000F
R34 ¹	315-0434-00			RES.,FXD,COMP:430K OHM,5%,0.25W	01121	CB4345
R35	315-0104-00			RES.,FXD,COMP:100K OHM,5%,0.25W	01121	CB1045
R36	321-0208-00			RES.,FXD,FILM:1.43K OHM,1%,0.125W	75042	CEAT0-1431F
R37	315-0621-00			RES.,FXD,COMP:620 OHM,5%,0.25W	01121	CB6215
R38	315-0621-00			RES.,FXD,COMP:620 OHM,5%,0.25W	01121	CB6215
R39	316-0101-00			RES.,FXD,COMP:100 OHM,10%,0.25W	01121	CB1011
R41	321-0190-00			RES.,FXD,FILM:931 OHM,1%,0.125W	75042	CEAT0-9310F
R42	316-0101-00			RES.,FXD,COMP:100 OHM,10%,0.25W	01121	CB1011
R43	321-0190-00			RES.,FXD,FILM:931 OHM,1%,0.125W	75042	CEAT0-9310F
R44	321-0098-01			RES.,FXD,FILM:102 OHM,0.5%,0.125W	75042	CEAT0-1020D
R45	321-0098-01			RES.,FXD,FILM:102 OHM,0.5%,0.125W	75042	CEAT0-1020D
R46	321-0126-01			RES.,FXD,FILM:200 OHM,0.5%,0.125W	91637	MFF1816G200R0D
R47	311-0635-00			RES.,VAR,NONWIR:1K OHM,10%,0.50W	80740	62-56-3
R48	311-0635-00			RES.,VAR,NONWIR:1K OHM,10%,0.50W	80740	62-56-3
R49	321-0080-01			RES.,FXD,FILM:66.5 OHM,0.5%,0.125W	91637	MFF1816G66R50F
R51	315-0510-00			RES.,FXD,COMP:51 OHM,5%,0.25W	01121	CB5105
R53	317-0047-00			RES.,FXD,COMP:4.7 OHM,5%,0.125W	01121	BB4R705
R54	316-0105-00			RES.,FXD,COMP:1M OHM,10%,0.25W	01121	CB1051
R56	317-0101-00			RES.,FXD,COMP:100 OHM,5%,0.125W	01121	BB1015
R65	321-0481-00			RES.,FXD,FILM:1M OHM,1%,0.125W	75042	CEAT0-1004F
R66	316-0474-00			RES.,FXD,COMP:470K OHM,10%,0.25W	01121	CB4741
R68	315-0361-00			RES.,FXD,COMP:360 OHM,5%,0.25W	01121	CB3615
R71	315-0470-00			RES.,FXD,COMP:47 OHM,5%,0.25W	01121	CB4705
R72	321-0030-02			RES.,FXD,FILM:20 OHM,0.5%,0.125W	75042	CEAT2-20R00D
R73	321-0030-02			RES.,FXD,FILM:20 OHM,0.5%,0.125W	75042	CEAT2-20R00D
R75	311-1227-00			RES.,VAR,NONWIR:5K OHM,20%,0.50W	80294	3389F-P31-502
R76	315-0123-00			RES.,FXD,COMP:12K OHM,5%,0.25W	01121	CB1235
R77	315-0151-00			RES.,FXD,COMP:150 OHM,5%,0.25W	01121	CB1515
R82	321-0208-00			RES.,FXD,FILM:1.43K OHM,1%,0.125W	75042	CEAT0-1431F
R83	321-0097-00			RES.,FXD,FILM:100 OHM,1%,0.125W	75042	CEAT0-1000F
R84 ¹	315-0434-00			RES.,FXD,COMP:430K OHM,5%,0.25W	01121	CB4345
R85	315-0104-00			RES.,FXD,COMP:100K OHM,5%,0.25W	01121	CB1045
R86	321-0208-00			RES.,FXD,FILM:1.43K OHM,1%,0.125W	75042	CEAT0-1431F
R87	315-0621-00			RES.,FXD,COMP:620 OHM,5%,0.25W	01121	CB6215
R88	315-0621-00			RES.,FXD,COMP:620 OHM,5%,0.25W	01121	CB6215
R91	321-0190-00			RES.,FXD,FILM:931 OHM,1%,0.125W	75042	CEAT0-9310F
R92	316-0101-00			RES.,FXD,COMP:100 OHM,10%,0.25W	01121	CB1011
R93	321-0190-00			RES.,FXD,FILM:931 OHM,1%,0.125W	75042	CEAT0-9310F
R94	321-0098-01			RES.,FXD,FILM:102 OHM,0.5%,0.125W	75042	CEAT0-1020D

¹Not included when 670-3023-00,-01, and -02 VERT OUTPUT Board is used.

Electrical Parts List—465 Service (SN B250000-up)

Ckt No.	Tektronix Part No.	Serial/Model No. Eff	Dscont	Name & Description	Mfr Code	Mfr Part Number
R95	321-0098-01			RES.,FXD,FILM:102 OHM,0.5%,0.125W	75042	CEATO-1020D
R96	321-0126-01			RES.,FXD,FILM:200 OHM,0.5%,0.125W	91637	MPF1816G200R0D
R97	311-0635-00			RES.,VAR,NONWIR:1K OHM,10%,0.50W	80740	62-56-3
R98	311-0635-00			RES.,VAR,NONWIR:1K OHM,10%,0.50W	80740	62-56-3
R99	321-0080-01			RES.,FXD,FILM:66.5 OHM,0.5%,0.125W	91637	MPF1816G66R50F
R101	315-0682-00			RES.,FXD,COMP:6.8K OHM,5%,0.25W	01121	CB6825
R102	321-0204-00			RES.,FXD,FILM:1.3K OHM,1%,0.125W	75042	CEATO-1301F
R103	321-0087-00			RES.,FXD,FILM:78.7 OHM,1%,0.125W	75042	CEATO-78R70F
R104	321-0204-00			RES.,FXD,FILM:1.3K OHM,1%,0.125W	75042	CEATO-1301F
R105	311-1226-00			RES.,VAR,NONWIR:2.5K OHM,20%,0.50W	80294	3389F-P31-252
R106	315-0301-00			RES.,FXD,COMP:300 OHM,5%,0.25W	01121	CB3015
R107	315-0270-00			RES.,FXD,COMP:27 OHM,5%,0.25W	01121	CB2705
R108	315-0301-00			RES.,FXD,COMP:300 OHM,5%,0.25W	01121	CB3015
R109	315-0270-00			RES.,FXD,COMP:27 OHM,5%,0.25W	01121	CB2705
R111	321-0026-00			RES.,FXD,FILM:18.2 OHM,1%,0.125W	75042	CEATO-18R20F
R112 ¹	311-1364-00			RES.,VAR,NONWIR:1K OHM,10%,0.50W	01121	10M321A
R113	321-0026-00			RES.,FXD,FILM:18.2 OHM,1%,0.125W	75042	CEATO-18R20F
R114	315-0103-00			RES.,FXD,COMP:10K OHM,5%,0.25W	01121	CB1035
R115	311-1228-00			RES.,VAR,NONWIR:10K OHM,20%,0.50W	80294	3389F-P31-103
R116	315-0123-00			RES.,FXD,COMP:12K OHM,5%,0.25W	01121	CB1235
R117	321-0085-00			RES.,FXD,FILM:75 OHM,1%,0.125W	75042	CEATO-75R00F
R118	311-1225-00			RES.,VAR,NONWIR:1K OHM,20%,0.50W	80294	3389F-P31-102
R119	321-0085-00			RES.,FXD,FILM:75 OHM,1%,0.125W	75042	CEATO-75R00F
R120	311-1007-00			RES.,VAR,NONWIR:20 OHM,20%,0.50W	80294	3329HG48-200
R121	321-0064-00			RES.,FXD,FILM:45.3 OHM,1%,0.125W	75042	CEATO-45R30F
R122	311-1224-00			RES.,VAR,NONWIR:500 OHM,20%,0.50W	80294	3389F-P31-501
R123	321-0055-00			RES.,FXD,FILM:36.5 OHM,1%,0.125W	75042	CEATO-36R50F
R125	316-0101-00			RES.,FXD,COMP:100 OHM,10%,0.25W	01121	CB1011
R127	321-0122-00			RES.,FXD,FILM:182 OHM,1%,0.125W	75042	CEATO-1820F
R128	321-0122-00			RES.,FXD,FILM:182 OHM,1%,0.125W	75042	CEATO-1820F
R130	321-0138-00			RES.,FXD,FILM:267 OHM,1%,0.125W	75042	CEATO-2670F
R132	321-0198-00			RES.,FXD,FILM:1.13K OHM,1%,0.125W	75042	CEATO-1131F
R133	321-0097-00			RES.,FXD,FILM:100 OHM,1%,0.125W	75042	CEATO-1000F
R134	321-0198-00			RES.,FXD,FILM:1.13K OHM,1%,0.125W	75042	CEATO-1131F
R135	316-0101-00			RES.,FXD,COMP:100 OHM,10%,0.25W	01121	CB1011
R136	315-0621-00			RES.,FXD,COMP:620 OHM,5%,0.25W	01121	CB6215
R137	316-0101-00			RES.,FXD,COMP:100 OHM,10%,0.25W	01121	CB1011
R138	315-0621-00			RES.,FXD,COMP:620 OHM,5%,0.25W	01121	CB6215
R141	316-0390-00			RES.,FXD,COMP:39 OHM,10%,0.25W	01121	CB3901
R142	315-0391-00			RES.,FXD,COMP:390 OHM,5%,0.25W	01121	CB3915
R143	321-0200-00			RES.,FXD,FILM:1.18K OHM,1%,0.125W	75042	CEATO-1181F
R144	321-0084-00			RES.,FXD,FILM:73.2 OHM,1%,0.125W	75042	CEATO-73R20F
R145	315-0100-00			RES.,FXD,COMP:10 OHM,5%,0.25W	01121	CB1005
R146	321-0200-00			RES.,FXD,FILM:1.18K OHM,1%,0.125W	75042	CEATO-1181F
R147	316-0390-00			RES.,FXD,COMP:39 OHM,10%,0.25W	01121	CB3901
R149	311-1225-00			RES.,VAR,NONWIR:1K OHM,20%,0.50W	80294	3389F-P31-102
R151	315-0331-00			RES.,FXD,COMP:330 OHM,5%,0.25W	01121	CB3315
R152	321-0160-00			RES.,FXD,FILM:453 OHM,1%,0.125W	75042	CEATO-4530F
R154	321-0201-00			RES.,FXD,FILM:1.21K OHM,1%,0.125W	75042	CEATO-1211F
R155	311-1224-00			RES.,VAR,NONWIR:500 OHM,20%,0.50W	80294	3389F-P31-501
R161	315-0331-00			RES.,FXD,COMP:330 OHM,5%,0.25W	01121	CB3315
R162	321-0064-00			RES.,FXD,FILM:45.3 OHM,1%,0.125W	75042	CEATO-45R30F
R164	315-0751-00			RES.,FXD,COMP:750 OHM,5%,0.25W	01121	CB7515

¹Furnished as a unit with S112.

Electrical Parts List—465 Service (SN B250000-up)

Ckt No.	Tektronix Part No.	Serial/Model No. Eff Dscont	Name & Description	Mfr Code	Mfr Part Number
R165	315-0331-00		RES.,FXD,COMP:330 OHM,5%,0.25W	01121	CB3315
R168	321-0064-00		RES.,FXD,FILM:45.3 OHM,1%,0.125W	75042	CEATO-45R30F
R169	316-0101-00		RES.,FXD,COMP:100 OHM,10%,0.25W	01121	CB1011
R201	315-0562-00		RES.,FXD,COMP:5.6K OHM,5%,0.25W	01121	CB5625
R202	321-0204-00		RES.,FXD,FILM:1.3K OHM,1%,0.125W	75042	CEATO-1301F
R203	321-0087-00		RES.,FXD,FILM:78.7 OHM,1%,0.125W	75042	CEATO-78R70F
R204	321-0204-00		RES.,FXD,FILM:1.3K OHM,1%,0.125W	75042	CEATO-1301F
R205	311-1226-00		RES.,VAR,NONWIR:2.5K OHM,20%,0.50W	80294	3389F-P31-252
R206	315-0301-00		RES.,FXD,COMP:300 OHM,5%,0.25W	01121	CB3015
R207	315-0270-00		RES.,FXD,COMP:27 OHM,5%,0.25W	01121	CB2705
R208	315-0301-00		RES.,FXD,COMP:300 OHM,5%,0.25W	01121	CB3015
R209	315-0270-00		RES.,FXD,COMP:27 OHM,5%,0.25W	01121	CB2705
R211	321-0026-00		RES.,FXD,FILM:18.2 OHM,1%,0.125W	75042	CEATO-18R20F
R212 ¹	311-1364-00		RES.,VAR,NONWIR:1K OHM,10%,0.50W	01121	10M321A
R213	321-0026-00		RES.,FXD,FILM:18.2 OHM,1%,0.125W	75042	CEATO-18R20F
R214	315-0103-00		RES.,FXD,COMP:10K OHM,5%,0.25W	01121	CB1035
R215	311-1228-00		RES.,VAR,NONWIR:10K OHM,20%,0.50W	80294	3389F-P31-103
R217	321-0085-00		RES.,FXD,FILM:75 OHM,1%,0.125W	75042	CEATO-75R00F
R218	311-1225-00		RES.,VAR,NONWIR:1K OHM,20%,0.50W	80294	3389F-P31-102
R219	321-0085-00		RES.,FXD,FILM:75 OHM,1%,0.125W	75042	CEATO-75R00F
R220	311-1007-00		RES.,VAR,NONWIR:20 OHM,20%,0.50W	80294	3329HG48-200
R221	321-0064-00		RES.,FXD,FILM:45.3 OHM,1%,0.125W	75042	CEATO-45R30F
R222	316-0101-00		RES.,FXD,COMP:100 OHM,10%,0.25W	01121	CB1011
R223	321-0055-00		RES.,FXD,FILM:36.5 OHM,1%,0.125W	75042	CEATO-36R50F
R224	316-0103-00		RES.,FXD,COMP:10K OHM,10%,0.25W	01121	CB1031
R225	316-0103-00		RES.,FXD,COMP:10K OHM,10%,0.25W	01121	CB1031
R226	316-0103-00		RES.,FXD,COMP:10K OHM,10%,0.25W	01121	CB1031
R227	321-0122-00		RES.,FXD,FILM:182 OHM,1%,0.125W	75042	CEATO-1820F
R228	321-0122-00		RES.,FXD,FILM:182 OHM,1%,0.125W	75042	CEATO-1820F
R229	316-0101-00		RES.,FXD,COMP:100 OHM,10%,0.25W	01121	CB1011
R230	321-0138-00		RES.,FXD,FILM:267 OHM,1%,0.125W	75042	CEATO-2670F
R232	321-0198-00		RES.,FXD,FILM:1.13K OHM,1%,0.125W	75042	CEATO-1131F
R233	321-0097-00		RES.,FXD,FILM:100 OHM,1%,0.125W	75042	CEATO-1000F
R234	321-0198-00		RES.,FXD,FILM:1.13K OHM,1%,0.125W	75042	CEATO-1131F
R235	316-0101-00		RES.,FXD,COMP:100 OHM,10%,0.25W	01121	CB1011
R236	315-0621-00		RES.,FXD,COMP:620 OHM,5%,0.25W	01121	CB6215
R237	316-0101-00		RES.,FXD,COMP:100 OHM,10%,0.25W	01121	CB1011
R238	315-0621-00		RES.,FXD,COMP:620 OHM,5%,0.25W	01121	CB6215
R241	316-0390-00		RES.,FXD,COMP:39 OHM,10%,0.25W	01121	CB3901
R242	315-0391-00		RES.,FXD,COMP:390 OHM,5%,0.25W	01121	CB3915
R243	321-0200-00		RES.,FXD,FILM:1.18K OHM,1%,0.125W	75042	CEATO-1181F
R244	321-0084-00		RES.,FXD,FILM:73.2 OHM,1%,0.125W	75042	CEATO-73R20F
R245	315-0270-00		RES.,FXD,COMP:27 OHM,5%,0.25W	01121	CB2705
R246	321-0200-00		RES.,FXD,FILM:1.18K OHM,1%,0.125W	75042	CEATO-1181F
R247	316-0390-00		RES.,FXD,COMP:39 OHM,10%,0.25W	01121	CB3901
R249	311-1225-00		RES.,VAR,NONWIR:1K OHM,20%,0.50W	80294	3389F-P31-102
R251	315-0331-00		RES.,FXD,COMP:330 OHM,5%,0.25W	01121	CB3315
R252	321-0160-00		RES.,FXD,FILM:453 OHM,1%,0.125W	75042	CEATO-4530F
R254	321-0201-00		RES.,FXD,FILM:1.21K OHM,1%,0.125W	75042	CEATO-1211F
R255	311-1224-00		RES.,VAR,NONWIR:500 OHM,20%,0.50W	80294	3389F-P31-501
R261	315-0751-00		RES.,FXD,COMP:750 OHM,5%,0.25W	01121	CB7515
R262	321-0064-00		RES.,FXD,FILM:45.3 OHM,1%,0.125W	75042	CEATO-45R30F
R301	311-1311-00		RES.,VAR,NONWIR:1K OHM,20%,1W	01121	10M155A

¹Furnished as a unit with S212.

Electrical Parts List—465 Service (SN B250000-up)

Ckt No.	Tektronix Part No.	Serial/Model No. Eff	Dscont	Name & Description	Mfr Code	Mfr Part Number
R302	321-0236-00			RES.,FXD,FILM:2.8K OHM,1%,0.125W	75042	CEATO-2801F
R311	311-1311-00			RES.,VAR,NONWIR:1K OHM,20%,1W	01121	10M155A
R312	321-0236-00			RES.,FXD,FILM:2.8K OHM,1%,0.125W	75042	CEATO-2801F
R321	321-0186-00			RES.,FXD,FILM:845 OHM,1%,0.125W	75042	CEATO-8450F
R322	321-0186-00			RES.,FXD,FILM:845 OHM,1%,0.125W	75042	CEATO-8450F
R323	321-0157-00			RES.,FXD,FILM:422 OHM,1%,0.125W	75042	CEATO-4220F
R324	321-0157-00			RES.,FXD,FILM:422 OHM,1%,0.125W	75042	CEATO-4220F
R325	321-0114-00			RES.,FXD,FILM:150 OHM,1%,0.125W	75042	CEATO-1500F
R326	323-0175-00			RES.,FXD,FILM:649 OHM,1%,0.50W	75042	CECTO-6490F
R327	321-0114-00			RES.,FXD,FILM:150 OHM,1%,0.125W	75042	CEATO-1500F
R331	323-0124-00			RES.,FXD,FILM:191 OHM,1%,0.50W	91637	MFF1226G191ROF
R332	316-0221-00			RES.,FXD,COMP:220 OHM,10%,0.25W	01121	CB2211
R334	316-0391-00			RES.,FXD,COMP:390 OHM,10%,0.25W	01121	CB3911
R335	321-0065-00			RES.,FXD,FILM:46.4 OHM,1%,0.125W	75042	CEATO-46R40F
R336	321-0065-00			RES.,FXD,FILM:46.4 OHM,1%,0.125W	75042	CEATO-46R40F
R340	311-1222-00			RES.,VAR,NONWIR:100 OHM,20%,0.50W	80294	3389F-P31-101
R341	323-0168-00			RES.,FXD,FILM:549 OHM,1%,0.50W	75042	CECTO-5490F
R342	321-0041-00			RES.,FXD,FILM:26.1 OHM,1%,0.125W	75042	CEATO-26R10F
R343	315-0101-00			RES.,FXD,COMP:100 OHM,5%,0.25W	01121	CB1015
R344	321-0093-00			RES.,FXD,FILM:90.9 OHM,1%,0.125W	75042	CEATO-90R90F
R345	321-0197-00			RES.,FXD,FILM:1.1K OHM,1%,0.125W	75042	CEATO-1101F
R346	321-0164-00			RES.,FXD,FILM:499 OHM,1%,0.125W	75042	CEATO-4990F
R347	321-0095-00			RES.,FXD,FILM:95.3 OHM,1%,0.125W	75042	CEATO-95R30F
R348	321-0114-00			RES.,FXD,FILM:150 OHM,1%,0.125W	75042	CEATO-1500F
R349	321-0068-00			RES.,FXD,FILM:49.9 OHM,1%,0.125W	75042	CEATO-49R90F
R351	315-0752-00			RES.,FXD,COMP:7.5K OHM,5%,0.25W	01121	CB7525
R352	321-0089-00			RES.,FXD,FILM:82.5 OHM,1%,0.125W	75042	CEATO-82R50F
R356	315-0683-00			RES.,FXD,COMP:68K OHM,5%,0.25W	01121	CB6835
R357	316-0101-00			RES.,FXD,COMP:100 OHM,10%,0.25W	01121	CB1011
R358	315-0202-00			RES.,FXD,COMP:2K OHM,5%,0.25W	01121	CB2025
R359	315-0272-00			RES.,FXD,COMP:2.7K OHM,5%,0.25W	01121	CB2725
R361	321-0193-00			RES.,FXD,FILM:1K OHM,1%,0.125W	75042	CEATO-1001F
R362	321-0158-00			RES.,FXD,FILM:432 OHM,1%,0.125W	75042	CEATO-4320F
R364	321-0212-00			RES.,FXD,FILM:1.58K OHM,1%,0.125W	75042	CEATO-1581F
R365	321-0229-00			RES.,FXD,FILM:2.37K OHM,1%,0.125W	75042	CEATO-2371F
R367	315-0201-00			RES.,FXD,COMP:200 OHM,5%,0.25W	01121	CB2015
R368	321-0122-00			RES.,FXD,FILM:182 OHM,1%,0.125W	75042	CEATO-1820F
R370	315-0123-00			RES.,FXD,COMP:12K OHM,5%,0.25W	01121	CB1235
R371	321-0193-00			RES.,FXD,FILM:1K OHM,1%,0.125W	75042	CEATO-1001F
R372	321-0158-00			RES.,FXD,FILM:432 OHM,1%,0.125W	75042	CEATO-4320F
R374	321-0212-00			RES.,FXD,FILM:1.58K OHM,1%,0.125W	75042	CEATO-1581F
R375	321-0229-00			RES.,FXD,FILM:2.37K OHM,1%,0.125W	75042	CEATO-2371F
R376	315-0201-00			RES.,FXD,COMP:200 OHM,5%,0.25W	01121	CB2015
R378	321-0122-00			RES.,FXD,FILM:182 OHM,1%,0.125W	75042	CEATO-1820F
R381	316-0152-00			RES.,FXD,COMP:1.5K OHM,10%,0.25W	01121	CB1521
R382	315-0473-00	XB251725		RES.,FXD,COMP:47K OHM,5%,0.25W	01121	CB4735
R383	316-0222-00			RES.,FXD,COMP:2.2K OHM,10%,0.25W	01121	CB2221
R384	316-0822-00			RES.,FXD,COMP:8.2K OHM,10%,0.25W	01121	CB8221
R388	316-0154-00			RES.,FXD,COMP:150K OHM,10%,0.25W	01121	CB1541
R389	316-0154-00			RES.,FXD,COMP:150K OHM,10%,0.25W	01121	CB1541
R391	316-0152-00			RES.,FXD,COMP:1.5K OHM,10%,0.25W	01121	CB1521
R392	315-0473-00	XB251725		RES.,FXD,COMP:47K OHM,5%,0.25W	01121	CB4735
R393	316-0222-00			RES.,FXD,COMP:2.2K OHM,10%,0.25W	01121	CB2221
R394	316-0822-00			RES.,FXD,COMP:8.2K OHM,10%,0.25W	01121	CB8221
R400	311-1139-00			RES.,VAR,NONWIR:500 OHM,20%,0.50W	73138	72XW-43-0-50LM

Electrical Parts List—465 Service (SN B250000-up)

Ckt No.	Tektronix Part No.	Serial/Model No. Eff	Dscont	Name & Description	Mfr Code	Mfr Part Number
R401	321-0068-00			RES.,FXD,FILM:49.9 OHM,1%,0.125W	75042	CEATO-49R90F
R402	321-0104-00			RES.,FXD,FILM:118 OHM,1%,0.125W	75042	CEATO-1180F
R403	315-0390-00			RES.,FXD,COMP:39 OHM,5%,0.25W	01121	CB3905
R404	321-0070-00			RES.,FXD,FILM:52.3 OHM,1%,0.125W	75042	CEATO-52R30F
R405	321-0187-00			RES.,FXD,FILM:866 OHM,1%,0.125W	75042	CEATO-8660F
R407	321-0175-00			RES.,FXD,FILM:649 OHM,1%,0.125W	75042	CEATO-6490F
R409	321-0178-00			RES.,FXD,FILM:698 OHM,1%,0.125W	75042	CEATO-6980F
R411	321-0068-00			RES.,FXD,FILM:49.9 OHM,1%,0.125W	75042	CEATO-49R90F
R414	321-0070-00			RES.,FXD,FILM:52.3 OHM,1%,0.125W	75042	CEATO-52R30F
R415	315-0100-00			RES.,FXD,COMP:10 OHM,5%,0.25W	01121	CB1005
R417	321-0175-00			RES.,FXD,FILM:649 OHM,1%,0.125W	75042	CEATO-6490F
R419	323-0071-00			RES.,FXD,FILM:53.6 OHM,1%,0.50W	75042	CECTO-53R60F
R421	315-0620-00			RES.,FXD,COMP:62 OHM,5%,0.25W	01121	CB6205
R423	311-0609-00			RES.,VAR,NONWIR:2K OHM,10%,0.50W	80740	62-57-3
R424	311-1239-00			RES.,VAR,NONWIR:2.5K OHM,10%,0.50W	73138	72Y-26-0-252K
R426	321-0423-00			RES.,FXD,FILM:249K OHM,1%,0.125W	75042	CEATO-2493F
R427	323-0144-00			RES.,FXD,FILM:309 OHM,1%,0.50W	75042	CECTO-3090F
R428	323-0144-00			RES.,FXD,FILM:309 OHM,1%,0.50W	75042	CECTO-3090F
R429	311-1236-00			RES.,VAR,NONWIR:250 OHM,10%,0.50W	73138	72X-22-0-251K
R433	311-1138-00			RES.,VAR,NONWIR:1K OHM,20%,0.50W	73138	72XW-44-0-102M
R434	311-1138-00			RES.,VAR,NONWIR:1K OHM,20%,0.50W	73138	72XW-44-0-102M
R437	323-0158-00			RES.,FXD,FILM:432 OHM,1%,0.50W	75042	CECTO-4320F
R438	323-0158-00			RES.,FXD,FILM:432 OHM,1%,0.50W	75042	CECTO-4320F
R440	321-0080-00			RES.,FXD,FILM:66.5 OHM,1%,0.125W	75042	CEATO-66R50F
R441	321-0064-00			RES.,FXD,FILM:45.3 OHM,1%,0.125W	75042	CEATO-45R30F
R442	311-1139-00			RES.,VAR,NONWIR:500 OHM,20%,0.50W	73138	72XW-43-0-501M
R443	321-0193-00			RES.,FXD,FILM:1K OHM,1%,0.125W	75042	CEATO-1001F
R444	315-0302-00			RES.,FXD,COMP:3K OHM,5%,0.25W	01121	CB3025
R445	315-0472-00			RES.,FXD,COMP:4.7K OHM,5%,0.25W	01121	CB4725
R446	321-0070-00			RES.,FXD,FILM:52.3 OHM,1%,0.125W	75042	CEATO-52R30F
R447	321-0070-00			RES.,FXD,FILM:52.3 OHM,1%,0.125W	75042	CEATO-52R30F
R448	322-0662-00			RES.,FXD,FILM:334 OHM,1%,0.25W	75042	CEBTO-3340F
R449	322-0180-00			RES.,FXD,FILM:732 OHM,1%,0.25W	75042	CEBTO-7320F
R451	321-0196-00			RES.,FXD,FILM:1.07K OHM,1%,0.125W	75042	CEATO-1071F
R452	315-0101-00			RES.,FXD,COMP:100 OHM,5%,0.25W	01121	CB1015
R453	321-0223-00			RES.,FXD,FILM:2.05K OHM,1%,0.125W	75042	CEATO-2051F
R454	321-0164-00			RES.,FXD,FILM:499 OHM,1%,0.125W	75042	CEATO-4990F
R455	311-1138-00			RES.,VAR,NONWIR:1K OHM,20%,0.50W	73138	72XW-44-0-102M
R457	315-0201-00			RES.,FXD,COMP:200 OHM,5%,0.25W	01121	CB2015
R461	317-0101-00			RES.,FXD,COMP:100 OHM,5%,0.125W	01121	BB1015
R464	310-0700-00			RES.,FXD,WW:430 OHM,1%,WW	80009	310-0700-00
R471	317-0101-00			RES.,FXD,COMP:100 OHM,5%,0.125W	01121	BB1015
R474	310-0700-00			RES.,FXD,WW:430 OHM,1%,WW	80009	310-0700-00
R502	315-0754-00			RES.,FXD,COMP:750K OHM,5%,0.25W	01121	CB7545
R503	315-0334-00			RES.,FXD,COMP:330K OHM,5%,0.25W	01121	CB3345
R507	321-0068-00			RES.,FXD,FILM:49.9 OHM,1%,0.125W	75042	CEATO-49R90F
R508	321-0068-00			RES.,FXD,FILM:49.9 OHM,1%,0.125W	75042	CEATO-49R90F
R509	321-0068-00			RES.,FXD,FILM:49.9 OHM,1%,0.125W	75042	CEATO-49R90F
R511	316-0104-00			RES.,FXD,COMP:100K OHM,10%,0.25W	01121	CB1041
R512	316-0563-00			RES.,FXD,COMP:56K OHM,10%,0.25W	01121	CB5631
R516	321-0481-00			RES.,FXD,FILM:1M OHM,1%,0.125W	75042	CEATO-1004F
R517	316-0101-00			RES.,FXD,COMP:100 OHM,10%,0.25W	01121	CB1011
R518	316-0101-00			RES.,FXD,COMP:100 OHM,10%,0.25W	01121	CB1011

Electrical Parts List—465 Service (SN B250000-up)

Ckt No.	Tektronix Part No.	Serial/Model No. Eff	Dscont	Name & Description	Mfr Code	Mfr Part Number
R522	316-0101-00			RES.,FXD,COMP:100 OHM,1%,0.25W	01121	CB1011
R523	316-0150-00			RES.,FXD,COMP:15 OHM,10%,0.25W	01121	CB1501
R524	316-0150-00			RES.,FXD,COMP:15 OHM,10%,0.25W	01121	CB1501
R525	316-0101-00			RES.,FXD,COMP:100 OHM,10%,0.25W	01121	CB1011
R527	321-0209-00			RES.,FXD,FILM:1.47K OHM,1%,0.125W	75042	CEATO-1471F
R528	315-0390-00			RES.,FXD,COMP:39 OHM,5%,0.25W	01121	CB3905
R529	321-0209-00			RES.,FXD,FILM:1.47K OHM,1%,0.125W	75042	CEATO-1471F
R530 ¹	311-1192-00			RES.,VAR,NONWIR:10K OHM,20%,1W	12697	CM39695
R531	316-0681-00			RES.,FXD,COMP:680 OHM,10%,0.25W	01121	CB6811
R535	311-1230-00			RES.,VAR,NONWIR:20K OHM,20%,0.50W	80294	3389F-P31-203
R536	315-0202-00			RES.,FXD,COMP:2K OHM,5%,0.25W	01121	CB2025
R537	315-0560-00			RES.,FXD,COMP:56 OHM,5%,0.25W	01121	CB5605
R538	315-0362-00			RES.,FXD,COMP:3.6K OHM,5%,0.25W	01121	CB3625
R539	316-0222-00			RES.,FXD,COMP:2.2K OHM,10%,0.25W	01121	CB2221
R540	316-0222-00			RES.,FXD,COMP:2.2K OHM,10%,0.25W	01121	CB2221
R541	316-0682-00			RES.,FXD,COMP:6.8K OHM,10%,0.25W	01121	CB6821
R542	316-0182-00			RES.,FXD,COMP:1.8K OHM,10%,0.25W	01121	CB1821
R544	316-0103-00			RES.,FXD,COMP:10K OHM,10%,0.25W	01121	CB1031
R545	311-1230-00			RES.,VAR,NONWIR:20K OHM,20%,0.50W	80294	3389F-P31-203
R546	315-0101-00			RES.,FXD,COMP:100 OHM,5%,0.25W	01121	CB1015
R547	315-0101-00			RES.,FXD,COMP:100 OHM,5%,0.25W	01121	CB1015
R549	315-0331-00			RES.,FXD,COMP:330 OHM,5%,0.25W	01121	CB3315
R550	316-0330-00			RES.,FXD,COMP:33 OHM,10%,0.25W	01121	CB3301
R551	323-0305-00			RES.,FXD,FILM:14.7K OHM,1%,0.50W	75042	CECTO-1472F
R552	316-0330-00			RES.,FXD,COMP:33 OHM,10%,0.25W	01121	CB3301
R553	316-0153-00			RES.,FXD,COMP:15K OHM,10%,0.25W	01121	CB1531
R554	316-0104-00			RES.,FXD,COMP:100K OHM,10%,0.25W	01121	CB1041
R555	311-1230-00			RES.,VAR,NONWIR:20K OHM,20%,0.50W	80294	3389F-P31-203
R556	316-0562-00			RES.,FXD,COMP:5.6K OHM,10%,0.25W	01121	CB5621
R557	321-0097-00			RES.,FXD,FILM:100 OHM,1%,0.125W	75042	CEATO-1000F
R558	321-0258-00			RES.,FXD,FILM:4.75K OHM,1%,0.125W	75042	CEATO-4751F
R602	316-0470-00			RES.,FXD,COMP:47 OHM,10%,0.25W	01121	CB4701
R603	325-0073-00			RES.,FXD,FILM:3.57M OHM,1%,0.50W	80009	325-0073-00
R604	321-0385-00			RES.,FXD,FILM:100K OHM,1%,0.125W	75042	CEATO-1003F
R606	323-0480-00			RES.,FXD,FILM:976K OHM,1%,0.50W	75042	CECTO-9763F
R607	321-0451-00			RES.,FXD,FILM:487K OHM,1%,0.125W	75042	CEATO-4873F
R608	315-0200-00			RES.,FXD,COMP:20 OHM,5%,0.25W	01121	CB2005
R609	316-0274-00			RES.,FXD,COMP:270K OHM,10%,0.25W	01121	CB2741
R611	316-0104-00			RES.,FXD,COMP:100K OHM,10%,0.25W	01121	CB1041
R612	316-0563-00			RES.,FXD,COMP:56K OHM,10%,0.25W	01121	CB5631
R616	321-0481-00			RES.,FXD,FILM:1M OHM,1%,0.125W	75042	CEATO-1004F
R617	316-0101-00			RES.,FXD,COMP:100 OHM,10%,0.25W	01121	CB1011
R618	316-0101-00			RES.,FXD,COMP:100 OHM,10%,0.25W	01121	CB1011
R622	316-0101-00			RES.,FXD,COMP:100 OHM,10%,0.25W	01121	CB1011
R623	316-0150-00			RES.,FXD,COMP:15 OHM,10%,0.25W	01121	CB1501
R624	316-0150-00			RES.,FXD,COMP:15 OHM,10%,0.25W	01121	CB1501
R625	316-0101-00			RES.,FXD,COMP:100 OHM,10%,0.25W	01121	CB1011
R627	321-0209-00			RES.,FXD,FILM:1.47K OHM,1%,0.125W	75042	CEATO-1471F
R628	315-0390-00			RES.,FXD,COMP:39 OHM,5%,0.25W	01121	CB3905
R629	321-0209-00			RES.,FXD,FILM:1.47K OHM,1%,0.125W	75042	CEATO-1471F
R630 ²	311-1192-00			RES.,VAR,NONWIR:10K OHM,20%,1W	12697	CM39695
R631	316-0681-00			RES.,FXD,COMP:680 OHM,10%,0.25W	01121	CB6811
R635	311-1230-00			RES.,VAR,NONWIR:20K OHM,20%,0.50W	80294	3389F-P31-203

¹Furnished as a unit with S530.

²Furnished as a unit with S630.

Electrical Parts List—465 Service (SN B250000-up)

Ckt No.	Tektronix Part No.	Serial/Model No. Eff	Dscont	Name & Description	Mfr Code	Mfr Part Number
R636	315-0202-00			RES.,FXD,COMP:2K OHM,5%,0.25W	01121	CB2025
R637	315-0560-00			RES.,FXD,COMP:56 OHM,5%,0.25W	01121	CB5605
R638	315-0362-00			RES.,FXD,COMP:3.6K OHM,5%,0.25W	01121	CB3625
R639	316-0222-00			RES.,FXD,COMP:2.2K OHM,10%,0.25W	01121	CB2221
R640	316-0222-00			RES.,FXD,COMP:2.2K OHM,10%,0.25W	01121	CB2221
R641	316-0682-00			RES.,FXD,COMP:6.8K OHM,10%,0.25W	01121	CB6821
R642	316-0182-00			RES.,FXD,COMP:1.8K OHM,10%,0.25W	01121	CB1821
R644	316-0103-00			RES.,FXD,COMP:10K OHM,10%,0.25W	01121	CB1031
R645	311-1230-00			RES.,VAR,NONWIR:20K OHM,20%,0.50W	80294	3389F-P31-203
R646	315-0101-00			RES.,FXD,COMP:100 OHM,5%,0.25W	01121	CB1015
R647	315-0101-00			RES.,FXD,COMP:100 OHM,5%,0.25W	01121	CB1015
R649	315-0331-00			RES.,FXD,COMP:330 OHM,5%,0.25W	01121	CB3315
R650	316-0330-00			RES.,FXD,COMP:33 OHM,10%,0.25W	01121	CB3301
R651	323-0305-00			RES.,FXD,FILM:14.7K OHM,1%,0.50W	75042	CECT0-1472F
R652	316-0330-00			RES.,FXD,COMP:33 OHM,10%,0.25W	01121	CB3301
R655	311-1230-00			RES.,VAR,NONWIR:20K OHM,20%,0.50W	80294	3389F-P31-203
R656	316-0562-00			RES.,FXD,COMP:5.6K OHM,10%,0.25W	01121	CB5621
R657	321-0097-00			RES.,FXD,FILM:100 OHM,1%,0.125W	75042	CEAT0-1000F
R658	321-0258-00			RES.,FXD,FILM:4.75K OHM,1%,0.125W	75042	CEAT0-4751F
R671	316-0100-00			RES.,FXD,COMP:10 OHM,10%,0.25W	01121	CB1001
R672	315-0680-00			RES.,FXD,COMP:68 OHM,5%,0.25W	01121	CB6805
R675	311-1259-00			RES.,VAR,NONWIR:100 OHM,10%,0.50W	80294	3329P-L58-101
R676	315-0510-00			RES.,FXD,COMP:51 OHM,(NOM VALUE),SEL	01121	CB5105
R677	315-0102-00			RES.,FXD,COMP:1K OHM,5%,0.25W	01121	CB1025
R678	315-0510-00			RES.,FXD,COMP:51 OHM,5%,0.25W	01121	CB5105
R679	315-0120-00			RES.,FXD,COMP:12 OHM,5%,0.25W	01121	CB1205
R681	316-0100-00			RES.,FXD,COMP:10 OHM,10%,0.25W	01121	CB1001
R682	315-0680-00			RES.,FXD,COMP:68 OHM,5%,0.25W	01121	CB6805
R683	315-0471-00			RES.,FXD,COMP:470 OHM,5%,0.25W	01121	CB4715
R687	315-0102-00			RES.,FXD,COMP:1K OHM,5%,0.25W	01121	CB1025
R688	315-0510-00			RES.,FXD,COMP:51 OHM,5%,0.25W	01121	CB5105
R689	315-0120-00			RES.,FXD,COMP:12 OHM,5%,0.25W	01121	CB1205
R690	316-0100-00			RES.,FXD,COMP:10 OHM,10%,0.25W	01121	CB1001
R691	316-0104-00			RES.,FXD,COMP:100K OHM,10%,0.25W	01121	CB1041
R692	315-0152-00			RES.,FXD,COMP:1.5K OHM,5%,0.25W	01121	CB1525
R694	315-0431-00			RES.,FXD,COMP:430 OHM,5%,0.25W	01121	CB4315
R803	315-0391-00			RES.,FXD,COMP:390 OHM,5%,0.25W	01121	CB3915
R804	321-0186-00			RES.,FXD,FILM:845 OHM,1%,0.125W	75042	CEAT0-8450F
R805	316-0220-00			RES.,FXD,COMP:22 OHM,10%,0.25W	01121	CB2201
R807	321-0243-00			RES.,FXD,FILM:3.32K OHM,1%,0.125W	75042	CEAT0-3321F
R808	321-0206-00			RES.,FXD,FILM:1.37K OHM,1%,0.125W	75042	CEAT0-1371F
R809	315-0132-00			RES.,FXD,COMP:1.3K OHM,5%,0.25W	01121	CB1325
R811	315-0390-00			RES.,FXD,COMP:39 OHM,5%,0.25W	01121	CB3905
R812	321-0211-00			RES.,FXD,FILM:1.54K OHM,1%,0.125W	75042	CEAT0-1541F
R814	315-0332-00			RES.,FXD,COMP:3.3K OHM,5%,0.25W	01121	CB3325
R815	315-0151-00			RES.,FXD,COMP:150 OHM,5%,0.25W	01121	CB1515
R817	315-0681-00			RES.,FXD,COMP:680 OHM,5%,0.25W	01121	CB6815
R818	315-0681-00			RES.,FXD,COMP:680 OHM,5%,0.25W	01121	CB6815
R822	315-0103-00			RES.,FXD,COMP:10K OHM,5%,0.25W	01121	CB1035
R823	315-0153-00			RES.,FXD,COMP:15K OHM,5%,0.25W	01121	CB1535
R824	315-0103-00			RES.,FXD,COMP:10K OHM,5%,0.25W	01121	CB1035
R827	315-0102-00			RES.,FXD,COMP:1K OHM,5%,0.25W	01121	CB1025
R828	315-0102-00			RES.,FXD,COMP:1K OHM,5%,0.25W	01121	CB1025

Electrical Parts List—465 Service (SN B250000-up)

Ckt No.	Tektronix Part No.	Serial/Model No. Eff Dscont	Name & Description	Mfr Code	Mfr Part Number
R829	316-0220-00		RES.,FXD,COMP:22 OHM,10%,0.25W	01121	CB2201
R831	315-0102-00		RES.,FXD,COMP:1K OHM,5%,0.25W	01121	CB1025
R834	315-0100-00		RES.,FXD,COMP:10 OHM,5%,0.25W	01121	CB1005
R836	315-0100-00		RES.,FXD,COMP:10 OHM,5%,0.25W	01121	CB1005
R838	316-0101-00		RES.,FXD,COMP:100 OHM,10%,0.25W	01121	CB1011
R853	315-0471-00		RES.,FXD,COMP:470 OHM,5%,0.25W	01121	CB4715
R854	321-0200-00		RES.,FXD,FILM:1.18K OHM,1%,0.125W	75042	CEATO-1181F
R855	316-0220-00		RES.,FXD,COMP:22 OHM,10%,0.25W	01121	CB2201
R856	316-0270-00		RES.,FXD,COMP:27 OHM,10%,0.25W	01121	CB2701
R857	321-0243-00		RES.,FXD,FILM:3.32K OHM,1%,0.125W	75042	CEATO-3321F
R858	321-0201-00		RES.,FXD,FILM:1.21K OHM,1%,0.125W	75042	CEATO-1211F
R859	315-0132-00		RES.,FXD,COMP:1.3K OHM,5%,0.25W	01121	CB1325
R861	315-0390-00		RES.,FXD,COMP:39 OHM,5%,0.25W	01121	CB3905
R862	321-0209-00		RES.,FXD,FILM:1.47K OHM,1%,0.125W	75042	CEATO-1471F
R863	315-0103-00		RES.,FXD,COMP:10K OHM,5%,0.25W	01121	CB1035
R864	315-0332-00		RES.,FXD,COMP:3.3K OHM,5%,0.25W	01121	CB3325
R865	315-0151-00		RES.,FXD,COMP:150 OHM,5%,0.25W	01121	CB1515
R866	315-0471-00		RES.,FXD,COMP:470 OHM,5%,0.25W	01121	CB4715
R871	315-0472-00		RES.,FXD,COMP:4.7K OHM,5%,0.25W	01121	CB4725
R872	315-0241-00		RES.,FXD,COMP:240 OHM,5%,0.25W	01121	CB2415
R877	315-0102-00		RES.,FXD,COMP:1K OHM,5%,0.25W	01121	CB1025
R879	315-0274-00		RES.,FXD,COMP:270K OHM,5%,0.25W	01121	CB2745
R1001	315-0360-00		RES.,FXD,COMP:36 OHM,5%,0.25W	01121	CB3605
R1002	303-0432-00		RES.,FXD,COMP:4.3K OHM,5%,1W	01121	GB4325
R1003	316-0101-00		RES.,FXD,COMP:100 OHM,10%,0.25W	01121	CB1011
R1004	315-0360-00		RES.,FXD,COMP:36 OHM,5%,0.25W	01121	CB3605
R1006	308-0421-00		RES.,FXD,WW:3K OHM,5%,3W	63743	36216
R1007	315-0271-00		RES.,FXD,COMP:270 OHM,5%,0.25W	01121	CB2715
R1011	316-0103-00		RES.,FXD,COMP:10K OHM,10%,0.25W	01121	CB1031
R1012	321-0164-00		RES.,FXD,FILM:499 OHM,1%,0.125W	75042	CEATO-4990F
R1013	321-0228-00		RES.,FXD,FILM:2.32K OHM,1%,0.125W	75042	CEATO-2321F
R1016	321-0195-00		RES.,FXD,FILM:1.05K OHM,1%,0.125W	75042	CEATO-1051F
R1017	321-0250-00		RES.,FXD,FILM:3.92K OHM,1%,0.125W	75042	CEATO-3921F
R1021	321-0193-00		RES.,FXD,FILM:1K OHM,1%,0.125W	75042	CEATO-1001F
R1022	321-0193-00		RES.,FXD,FILM:1K OHM,1%,0.125W	75042	CEATO-1001F
R1024	321-0165-00		RES.,FXD,FILM:511 OHM,1%,0.125W	75042	CEATO-5110F
R1026	316-0181-00		RES.,FXD,COMP:180 OHM,10%,0.25W	01121	CB1811
R1029	316-0101-00		RES.,FXD,COMP:100 OHM,10%,0.25W	01121	CB1011
R1031	316-0470-00		RES.,FXD,COMP:47 OHM,10%,0.25W	01121	CB4701
R1032	316-0101-00		RES.,FXD,COMP:100 OHM,10%,0.25W	01121	CB1011
R1033	321-0256-00		RES.,FXD,FILM:4.53K OHM,1%,0.125W	75042	CEATO-4531F
R1035	316-0101-00		RES.,FXD,COMP:100 OHM,10%,0.25W	01121	CB1011
R1037	321-0251-01		RES.,FXD,FILM:4.02K OHM,0.5%,0.125W	75042	CEATO-4021F
R1038	316-0470-00		RES.,FXD,COMP:47 OHM,10%,0.25W	01121	CB4701
R1039	321-0228-00		RES.,FXD,FILM:2.32K OHM,1%,0.125W	75042	CEATO-2321F
R1041	316-0101-00		RES.,FXD,COMP:100 OHM,10%,0.25W	01121	CB1011
R1044	321-0227-00		RES.,FXD,FILM:2.26K OHM,1%,0.125W	75042	CEATO-2261F
R1045	316-0101-00		RES.,FXD,COMP:100 OHM,10%,0.25W	01121	CB1011
R1046	301-0562-00		RES.,FXD,COMP:5.6K OHM,5%,0.50W	01121	EB5625
R1047	315-0681-00		RES.,FXD,COMP:680 OHM,5%,0.25W	01121	CB6815
R1048	315-0752-00		RES.,FXD,COMP:7.5K OHM,5%,0.25W	01121	CB7525
R1049	315-0681-00		RES.,FXD,COMP:680 OHM,5%,0.25W	01121	CB6815
R1052	315-0561-00		RES.,FXD,COMP:560 OHM,5%,0.25W	01121	CB5615

Electrical Parts List—465 Service (SN B250000-up)

Ckt No.	Tektronix Part No.	Serial/Model No. Eff	Dscont	Name & Description	Mfr Code	Mfr Part Number
R1053	301-0622-00			RES.,FXD,COMP:6.2K OHM,5%,0.50W	01121	EB6225
R1054	315-0102-00			RES.,FXD,COMP:1K OHM,5%,0.25W	01121	CB1025
R1057	315-0562-00			RES.,FXD,COMP:5.6K OHM,5%,0.25W	01121	CB5625
R1061	315-0360-00			RES.,FXD,COMP:36 OHM,5%,0.25W	01121	CB3605
R1062	301-0432-00			RES.,FXD,COMP:4.3K OHM,5%,0.50W	01121	EB4325
R1063	316-0101-00			RES.,FXD,COMP:100 OHM,10%,0.25W	01121	CB1011
R1064	315-0360-00			RES.,FXD,COMP:36 OHM,5%,0.25W	01121	CB3605
R1065	316-0220-00			RES.,FXD,COMP:22 OHM,10%,0.25W	01121	CB2201
R1066	308-0421-00			RES.,FXD,WW:3K OHM,5%,3W	63743	36216
R1071	316-0103-00			RES.,FXD,COMP:10K OHM,10%,0.25W	01121	CB1031
R1072	321-0164-00			RES.,FXD,FILM:499 OHM,1%,0.125W	75042	CEATO-4990F
R1073	321-0228-00			RES.,FXD,FILM:2.32K OHM,1%,0.125W	75042	CEATO-2321F
R1076	321-0195-00			RES.,FXD,FILM:1.05K OHM,1%,0.125W	75042	CEATO-1051F
R1077	321-0250-00			RES.,FXD,FILM:3.92K OHM,1%,0.125W	75042	CEATO-3921F
R1081	321-0193-00			RES.,FXD,FILM:1K OHM,1%,0.125W	75042	CEATO-1001F
R1082	321-0193-00			RES.,FXD,FILM:1K OHM,1%,0.125W	75042	CEATO-1001F
R1084	321-0165-00			RES.,FXD,FILM:511 OHM,1%,0.125W	75042	CEATO-5110F
R1086	316-0181-00			RES.,FXD,COMP:180 OHM,10%,0.25W	01121	CB1811
R1089	316-0101-00			RES.,FXD,COMP:100 OHM,10%,0.25W	01121	CB1011
R1091	316-0470-00			RES.,FXD,COMP:47 OHM,10%,0.25W	01121	CB4701
R1092	316-0101-00			RES.,FXD,COMP:100 OHM,10%,0.25W	01121	CB1011
R1093	321-0256-00			RES.,FXD,FILM:4.53K OHM,1%,0.125W	75042	CEATO-4531F
R1095	316-0101-00			RES.,FXD,COMP:100 OHM,10%,0.25W	01121	CB1011
R1097	321-0251-01			RES.,FXD,FILM:4.02K OHM,0.5%,0.125W	75042	CEATO-4021F
R1098	321-0229-00			RES.,FXD,FILM:2.37K OHM,1%,0.125W	75042	CEATO-2371F
R1101	315-0682-00			RES.,FXD,COMP:6.8K OHM,5%,0.25W	01121	CB6825
R1110	311-1464-00			RES.,VAR,WW:2K OHM,5%,2W	02111	534-265
R1110 ¹	311-1709-00			RES.,VAR,WW:20K OHM,10%,2W	80294	8136-22-0
R1111	321-0169-00			RES.,FXD,FILM:562 OHM,(NOM VALUE),SEL	75042	CEATO-5620F
R1111 ¹	321-0265-00			RES.,FXD,FILM:5.62K OHM,1%,0.125W	75042	CEATO-5621F
R1112	321-0068-00			RES.,FXD,FILM:49.9 OHM,(NOM VALUE),SEL	75042	CEATO-49R90
R1112 ¹	321-0252-00			RES.,FXD,FILM:4.12K OHM,1%,0.125W	75042	CEATO-4121F
R1113	321-0125-00			RES.,FXD,FILM:196 OHM,(NOM VALUE),SEL	75042	CEATO-1960F
R1113 ¹	321-0154-00			RES.,FXD,FILM:392 OHM,1%,0.125W	75042	CEATO-3920F
R1115	311-1244-00			RES.,VAR,NONWIR:100 OHM,10%,0.50W	80294	3386X-T07-101
R1117	321-0231-00			RES.,FXD,FILM:2.49K OHM,1%,0.125W	75042	CEATO-2491F
R1130	315-0101-00			RES.,FXD,COMP:100 OHM,5%,0.25W	01121	CB1015
R1131	323-0498-04			RES.,FXD,FILM:1.5M OHM,0.1%,0.50W	91637	MFF1226D15003B
R1133	323-0481-04			RES.,FXD,FILM:1M OHM,0.1%,0.50W	91637	MFF1226D10003B
R1134	321-0648-04			RES.,FXD,FILM:500K OHM,0.1%,0.125W	91637	MFF1816D50002B
R1135	321-0618-04			RES.,FXD,FILM:250K OHM,0.1%,0.125W	91637	MFF1816D25002B
R1136	321-0414-04			RES.,FXD,FILM:200K OHM,0.1%,0.125W	91637	MFF1816D20002B
R1137	321-0385-04			RES.,FXD,FILM:100K OHM,0.1%,0.125W	91637	MFF1816D10002B
R1138	321-0756-04			RES.,FXD,FILM:50K OHM,0.1%,0.125W	75042	CEAT2-5002B
R1140 ²	311-1701-00			RES.,VAR,NONWIR:50K OHM,20%,1W	01121	12M572
R1141	315-0154-00			RES.,FXD,COMP:150K OHM,5%,0.25W	01121	CB1545
R1142 ³	321-0222-07			RES.,FXD,FILM:2K OHM,0.1%,0.125W	75042	CEAT9-2001D
R1143 ³	321-0193-07			RES.,FXD,FILM:1K OHM,0.1%,0.125W	75042	CEAT9-1001B
R1144 ³	321-0193-07			RES.,FXD,FILM:1K OHM,0.1%,0.125W	75042	CEAT9-1001B
R1145	311-1245-00			RES.,VAR,NONWIR:10K OHM,10%,0.50W	73138	72X-23-0-501K
R1146	315-0472-00			RES.,FXD,COMP:4.7K OHM,5%,0.25W	01121	CB4725
R1151	321-0429-00			RES.,FXD,FILM:287K OHM,1%,0.125W	75042	CEATO-2873F
R1153	321-0338-00			RES.,FXD,FILM:32.4K OHM,1%,0.125W	75042	CEATO-3242F
R1155 ⁴	311-1410-00			RES.,VAR,NONWIR:25K OHM,20%,1W	80009	311-1410-00
R1161	323-0498-04			RES.,FXD,FILM:1.5M OHM,0.1%,0.50W	91637	MFF1226D15003B
R1163	323-0481-04			RES.,FXD,FILM:1M OHM,0.1%,0.50W	91637	MFF1226D10003B
R1164	321-0648-04			RES.,FXD,FILM:500K OHM,0.1%,0.125W	91637	MFF1816D50002B

¹DM43/DM40 only.

²Furnished as a unit with S1140.

³Refer to DM43/DM40.

⁴Furnished as a unit with S1155A,B.

Electrical Parts List—465 Service (SN B250000-up)

Ckt No.	Tektronix Part No.	Serial/Model No. Eff Dscont	Name & Description	Mfr Code	Mfr Part Number
R1165	321-0618-04		RES.,FXD,FILM:250K OHM,0.1%,0.125W	91637	MFF1816D25002B
R1166	321-0414-04		RES.,FXD,FILM:200K OHM,0.1%,0.125W	91637	MFF1816D20002B
R1167	321-0385-04		RES.,FXD,FILM:100K OHM,0.1%,0.125W	91637	MFF1816D10002B
R1168	321-0756-04		RES.,FXD,FILM:50K OHM,0.1%,0.125W	75042	CEAT2-5002B
R1170	315-0473-00		RES.,FXD,COMP:47K OHM,5%,0.25W	01121	CB4735
R1175	311-1245-00		RES.,VAR,NONWIR:10K OHM,10%,0.50W	73138	72X-23-0-501K
R1201	316-0471-00		RES.,FXD,COMP:470 OHM,10%,0.25W	01121	CB4711
R1202	321-0212-00		RES.,FXD,FILM:1.58K OHM,1%,0.125W	75042	CEAT0-1581F
R1205A,B	311-1430-00		RES.,VAR,NONWIR:5K OHM X 50K OHM,20%,0.50W	01121	10M457
R1206	315-0202-00		RES.,FXD,COMP:2K OHM,5%,0.25W	01121	CB2025
R1207	315-0203-00		RES.,FXD,COMP:20K OHM,5%,0.25W	01121	CB2035
R1208	315-0432-00		RES.,FXD,COMP:4.3K OHM,5%,0.25W	01121	CB4325
R1209	315-0433-00		RES.,FXD,COMP:43K OHM,5%,0.25W	01121	CB4335
R1211	321-0130-00		RES.,FXD,FILM:221 OHM,1%,0.125W	75042	CEAT0-2210F
R1212	316-0102-00		RES.,FXD,COMP:1K OHM,10%,0.25W	01121	CB1021
R1214	321-0174-00		RES.,FXD,FILM:634 OHM,1%,0.125W	75042	CEAT0-6340F
R1215	311-1222-00		RES.,VAR,NONWIR:100 OHM,20%,0.50W	80294	3389F-P31-101
R1216	321-0264-00		RES.,FXD,FILM:5.49K OHM,1%,0.125W	75042	CEAT0-5491F
R1217	321-0147-00		RES.,FXD,FILM:332 OHM,1%,0.125W	75042	CEAT0-3320F
R1218	315-0152-00		RES.,FXD,COMP:1.5K OHM,5%,0.25W	01121	CB1525
R1219	321-0164-00		RES.,FXD,FILM:499 OHM,1%,0.125W	75042	CEAT0-4990F
R1220	321-0034-00		RES.,FXD,FILM:22.1 OHM,1%,0.125W	75042	CEAT0-22R10F
R1221	321-0173-00		RES.,FXD,FILM:619 OHM,1%,0.125W	75042	CEAT0-6190F
R1222	321-0173-00		RES.,FXD,FILM:619 OHM,1%,0.125W	75042	CEAT0-6190F
R1223	321-0184-00		RES.,FXD,FILM:806 OHM,1%,0.125W	75042	CEAT0-8060F
R1224	323-0248-00		RES.,FXD,FILM:3.74K OHM,1%,0.50W	75042	CECT0-3741F
R1225	311-1226-00		RES.,VAR,NONWIR:2.5K OHM,20%,0.50W	80294	3389F-P31-252
R1226	323-0296-00		RES.,FXD,FILM:11.8K OHM,1%,0.50W	75042	CECT0-1182F
R1228	321-0210-00		RES.,FXD,FILM:1.5K OHM,1%,0.125W	75042	CEAT0-1501F
R1229	316-0154-00		RES.,FXD,COMP:150K OHM,10%,0.25W	01121	CB1541
R1231	321-0222-00		RES.,FXD,FILM:2K OHM,1%,0.125W	75042	CEAT0-2001F
R1232	315-0270-00		RES.,FXD,COMP:27 OHM,5%,0.25W	01121	CB2705
R1233	321-0184-00		RES.,FXD,FILM:806 OHM,1%,0.125W	75042	CEAT0-8060F
R1234	323-0248-00		RES.,FXD,FILM:3.74K OHM,1%,0.50W	75042	CECT0-3741F
R1235	323-0191-00		RES.,FXD,FILM:953 OHM,1%,0.50W	75042	CECT0-9530F
R1236	323-0296-00		RES.,FXD,FILM:11.8K OHM,1%,0.50W	75042	CECT0-1182F
R1237	311-1225-00		RES.,VAR,NONWIR:1K OHM,20%,0.50W	80294	3389F-P31-102
R1238	311-1222-00		RES.,VAR,NONWIR:100 OHM,20%,0.50W	80294	3389F-P31-101
R1239	321-0110-00		RES.,FXD,FILM:137 OHM,1%,0.125W	75042	CEAT0-1370F
R1241	321-0168-00		RES.,FXD,FILM:549 OHM,1%,0.125W	75042	CEAT0-5490F
R1242	321-0168-00		RES.,FXD,FILM:549 OHM,1%,0.125W	75042	CEAT0-5490F
R1244	321-0122-00		RES.,FXD,FILM:182 OHM,1%,0.125W	75042	CEAT0-1820F
R1246	321-0260-00		RES.,FXD,FILM:4.99K OHM,1%,0.125W	75042	CEAT0-4991F
R1247	315-0201-00		RES.,FXD,COMP:200 OHM,5%,0.25W	01121	CB2015
R1248	321-0228-00		RES.,FXD,FILM:2.32K OHM,1%,0.125W	75042	CEAT0-2321F
R1249	315-0182-00		RES.,FXD,COMP:1.8K OHM,5%,0.25W	01121	CB1825
R1253	321-0299-00		RES.,FXD,FILM:12.7K OHM,1%,0.125W	75042	CEAT0-1272F
R1254	321-0140-00		RES.,FXD,FILM:280 OHM,1%,0.125W	75042	CEAT0-2800F
R1255	302-0181-00		RES.,FXD,COMP:180 OHM,10%,0.50W	01121	EB1811
R1260	322-0289-00		RES.,FXD,FILM:10K OHM,1%,0.25W	75042	CEBTO-1002F
R1261	322-0289-00		RES.,FXD,FILM:10K OHM,1%,0.25W	75042	CEBTO-1002F
R1262	321-0189-00		RES.,FXD,FILM:909 OHM,1%,0.125W	75042	CEAT0-9090F
R1263	316-0470-00		RES.,FXD,COMP:47 OHM,10%,0.25W	01121	CB4701

Electrical Parts List—465 Service (SN B250000-up)

Ckt No.	Tektronix Part No.	Serial/Model No. Eff	Dscont	Name & Description	Mfr Code	Mfr Part Number
R1264	302-0393-00			RES.,FXD,COMP:39K OHM,1%,0.50W	01121	EB3931
R1266	316-0101-00			RES.,FXD,COMP:100 OHM,1%,0.25W	01121	CB1011
R1268	321-0222-00			RES.,FXD,FILM:2K OHM,1%,0.125W	75042	CEATO-2001F
R1269	321-0268-00			RES.,FXD,FILM:6.04K OHM,1%,0.125W	75042	CEATO-6041F
R1273	321-0299-00			RES.,FXD,FILM:12.7K OHM,1%,0.125W	75042	CEATO-1272F
R1274	323-0177-00			RES.,FXD,FILM:680 OHM,1%,0.50W	75042	CECTO-6810F
R1275	302-0221-00			RES.,FXD,COMP:220 OHM,10%,0.50W	01121	EB2211
R1280	322-0289-00			RES.,FXD,FILM:10K OHM,1%,0.25W	75042	CEBTO-1002F
R1281	322-0289-00			RES.,FXD,FILM:10K OHM,1%,0.25W	75042	CEBTO-1002F
R1282	321-0189-00			RES.,FXD,FILM:909 OHM,1%,0.125W	75042	CEATO-9090F
R1283	316-0470-00			RES.,FXD,COMP:47 OHM,10%,0.25W	01121	CB4701
R1284	302-0393-00			RES.,FXD,COMP:39K OHM,10%,0.50W	01121	EB3931
R1286	316-0101-00			RES.,FXD,COMP:100 OHM,10%,0.25W	01121	CB1011
R1288	316-0470-00			RES.,FXD,COMP:47 OHM,10%,0.25W	01121	CB4701
R1289	302-0273-00			RES.,FXD,COMP:27K OHM,10%,0.50W	01121	EB2731
R1301	321-0160-00			RES.,FXD,FILM:453 OHM,1%,0.125W	75042	CEATO-4530F
R1302	321-0160-00			RES.,FXD,FILM:453 OHM,1%,0.125W	75042	CEATO-4530F
R1303	321-0209-00			RES.,FXD,FILM:1.47K OHM,1%,0.125W	75042	CEATO-1471F
R1304	315-0472-00			RES.,FXD,COMP:4.7K OHM,5%,0.25W	01121	CB4725
R1306	315-0112-00			RES.,FXD,COMP:1.1K OHM,5%,0.25W	01121	CB1125
R1307	321-0192-00			RES.,FXD,FILM:976 OHM,1%,0.125W	75042	CEATO-9760F
R1308	321-0171-00			RES.,FXD,FILM:590 OHM,1%,0.125W	75042	CEATO-5900F
R1314	315-0911-00			RES.,FXD,COMP:910 OHM,5%,0.25W	01121	CB9115
R1315	315-0221-00			RES.,FXD,COMP:220 OHM,5%,0.25W	01121	CB2215
R1317	301-0471-00			RES.,FXD,COMP:470 OHM,5%,0.50W	01121	EB4715
R1321	321-0160-00			RES.,FXD,FILM:453 OHM,1%,0.125W	75042	CEATO-4530F
R1322	321-0160-00			RES.,FXD,FILM:453 OHM,1%,0.125W	75042	CEATO-4530F
R1323	321-0209-00			RES.,FXD,FILM:1.47K OHM,1%,0.125W	75042	CEATO-1471F
R1324	315-0472-00			RES.,FXD,COMP:4.7K OHM,5%,0.25W	01121	CB4725
R1326	315-0112-00			RES.,FXD,COMP:1.1K OHM,5%,0.25W	01121	CB1125
R1327	321-0192-00			RES.,FXD,FILM:976 OHM,1%,0.125W	75042	CEATO-9760F
R1328	321-0171-00			RES.,FXD,FILM:590 OHM,1%,0.125W	75042	CEATO-5900F
R1334	315-0911-00			RES.,FXD,COMP:910 OHM,5%,0.25W	01121	CB9115
R1335	315-0221-00			RES.,FXD,COMP:220 OHM,5%,0.25W	01121	CB2215
R1337	301-0471-00			RES.,FXD,COMP:470 OHM,5%,0.50W	01121	EB4715
R1339	316-0220-00			RES.,FXD,COMP:22 OHM,10%,0.25W	01121	CB2201
R1345	315-0202-00			RES.,FXD,COMP:2K OHM,5%,0.25W	01121	CB2025
R1348	316-0220-00			RES.,FXD,COMP:22 OHM,10%,0.25W	01121	CB2201
R1349	316-0220-00			RES.,FXD,COMP:22 OHM,10%,0.25W	01121	CB2201
R1400	311-1228-00			RES.,VAR,NONWIR:10K OHM,20%,0.50W	80294	3389F-P31-103
R1401	322-0464-00			RES.,FXD,FILM:665K OHM,1%,0.25W	75042	CEBTO-6653F
R1402	316-0224-00			RES.,FXD,COMP:220K OHM,10%,0.25W	01121	CB2241
R1403	315-0273-00			RES.,FXD,COMP:27K OHM,5%,0.25W	01121	CB2735
R1404	315-0103-00			RES.,FXD,COMP:10K OHM,5%,0.25W	01121	CB1035
R1406	316-0683-00			RES.,FXD,COMP:68K OHM,10%,0.25W	01121	CB6831
R1407	316-0102-00			RES.,FXD,COMP:1K OHM,10%,0.25W	01121	CB1021
R1408	315-0242-00			RES.,FXD,COMP:2.4K OHM,5%,0.25W	01121	CB2425
R1409	316-0104-00			RES.,FXD,COMP:100K OHM,10%,0.25W	01121	CB1041
R1411	321-0327-00			RES.,FXD,FILM:24.9K OHM,1%,0.125W	75042	CEATO-2492F
R1412	321-0329-00			RES.,FXD,FILM:26.1K OHM,1%,0.125W	75042	CEATO-2612F
R1413	316-0103-00			RES.,FXD,COMP:10K OHM,10%,0.25W	01121	CB1031
R1414	316-0392-00			RES.,FXD,COMP:3.9K OHM,10%,0.25W	01121	CB3921
R1416	316-0472-00			RES.,FXD,COMP:4.7K OHM,10%,0.25W	01121	CB4721

Electrical Parts List—465 Service (SN B250000-up)

Ckt No.	Tektronix Part No.	Serial/Model No. Eff Dscont	Name & Description	Mfr Code	Mfr Part Number
R1420	315-0394-00		RES.,FXD,COMP:390K OHM,5%,0.25W	01121	CB3945
R1421	316-0103-00		RES.,FXD,COMP:10K OHM,10%,0.25W	01121	CB1031
R1422	316-0103-00		RES.,FXD,COMP:10K OHM,10%,0.25W	01121	CB1031
R1423	316-0103-00		RES.,FXD,COMP:10K OHM,10%,0.25W	01121	CB1031
R1427	316-0106-00		RES.,FXD,COMP:10M OHM,10%,0.25W	01121	CB1061
R1428	315-0182-00		RES.,FXD,COMP:1.8K OHM,5%,0.25W	01121	CB1825
R1430	311-0075-00		RES.,VAR,NONWIR:5M OHM,20%,0.20W	12697	381-CM16993
R1431A	307-0290-04		RES.,FXD,FILM:6.57M OHM	80009	307-0290-04
R1431B			RES.,FXD,FILM:23.6M OHM		
R1431C			RES.,FXD,FILM:550K OHM		
R1431D			RES.,FXD,FILM:24.5M OHM		
R1434 ¹	311-1538-00		RES.,VAR,NONWIR:5K OHM X 2.5M OHM,10%	01121	11M518
R1440	311-1313-00		RES.,VAR,NONWIR:2K OHM,20%,1W	01121	10M157A
R1442	311-1235-00		RES.,VAR,NONWIR:100K OHM,20%,0.50W	80294	3389F-P31-104
R1445	311-1372-00		RES.,VAR,NONWIR:100K OHM,20%,1W	01121	10M335A
R1446	311-1227-00		RES.,VAR,NONWIR:5K OHM,20%,0.50W	80294	3389F-P31-502
R1447	315-0223-00		RES.,FXD,COMP:22K OHM,5%,0.25W	01121	CB2235
R1448	315-0183-00		RES.,FXD,COMP:18K OHM,5%,0.25W	01121	CB1835
R1449	316-0101-00		RES.,FXD,COMP:100 OHM,10%,0.25W	01121	CB1011
R1451	301-0243-00		RES.,FXD,COMP:24K OHM,5%,0.50W	01121	EB2435
R1452	316-0221-00		RES.,FXD,COMP:220 OHM,10%,0.25W	01121	CB2211
R1453	316-0470-00		RES.,FXD,COMP:47 OHM,10%,0.25W	01121	CB4701
R1460 ¹	311-1538-00		RES.,VAR,NONWIR:5K OHM X 2.5M OHM,10%	01121	11M518
R1461	315-0302-00		RES.,FXD,COMP:3K OHM,5%,0.25W	01121	CB3025
R1462	315-0242-00		RES.,FXD,COMP:2.4K OHM,5%,0.25W	01121	CB2425
R1463	315-0122-00		RES.,FXD,COMP:1.2K OHM,5%,0.25W	01121	CB1225
R1464	315-0153-00		RES.,FXD,COMP:15K OHM,5%,0.25W	01121	CB1535
R1466	321-0220-00		RES.,FXD,FILM:1.91K OHM,1%,0.125W	75042	CEATO-1911F
R1467	321-0168-00		RES.,FXD,FILM:549 OHM,1%,0.125W	75042	CEATO-5490F
R1468	321-0249-00		RES.,FXD,FILM:3.83K OHM,1%,0.125W	75042	CEATO-3831F
R1469	323-0322-00		RES.,FXD,FILM:22.1K OHM,1%,0.5W	75042	CECTO-2212F
R1470	321-0307-00		RES.,FXD,FILM:15.4K OHM,1%,0.125W	75042	CEATO-1542F
R1471	316-0101-00		RES.,FXD,COMP:100 OHM,10%,0.25W	01121	CB1011
R1472	316-0391-00		RES.,FXD,COMP:390 OHM,10%,0.25W	01121	CB3911
R1473	316-0102-00		RES.,FXD,COMP:1K OHM,10%,0.25W	01121	CB1021
R1474	316-0101-00		RES.,FXD,COMP:100 OHM,10%,0.25W	01121	CB1011
R1475	316-0102-00		RES.,FXD,COMP:1K OHM,10%,0.25W	01121	CB1021
R1476	315-0911-00		RES.,FXD,COMP:910 OHM,5%,0.25W	01121	CB9115
R1477	321-0201-00		RES.,FXD,FILM:1.21K OHM,1%,0.125W	75042	CEATO-1211F
R1478	302-0393-00		RES.,FXD,COMP:39K OHM,10%,0.50W	01121	EB3931
R1480	311-1231-00		RES.,VAR,NONWIR:25K OHM,20%,0.50W	80294	3389F-P31-253
R1481	316-0103-00		RES.,FXD,COMP:10K OHM,10%,0.25W	01121	CB1031
R1482	316-0102-00		RES.,FXD,COMP:1K OHM,10%,0.25W	01121	CB1021
R1484	316-0471-00		RES.,FXD,COMP:470 OHM,10%,0.25W	01121	CB4711
R1485	316-0221-00		RES.,FXD,COMP:220 OHM,10%,0.25W	01121	CB2211
R1486	316-0226-00		RES.,FXD,COMP:22M OHM,10%,0.25W	01121	CB2261
R1488	316-0102-00		RES.,FXD,COMP:1K OHM,10%,0.25W	01121	CB1021
R1510	316-0103-00		RES.,FXD,COMP:10K OHM,10%,0.25W	01121	CB1031
R1511	316-0103-00		RES.,FXD,COMP:10K OHM,10%,0.25W	01121	CB1031
R1516	308-0363-00		RES.,FXD,WW:3K OHM,5%,8W	91637	RS8-B30000F
R1517	315-0200-00		RES.,FXD,COMP:20 OHM,5%,0.25W	01121	CB2005
R1518	303-0203-00		RES.,FXD,COMP:20K OHM,5%,1W	01121	GB2035
R1519	315-0101-00		RES.,FXD,COMP:100 OHM,5%,0.25W	01121	CB1015
R1521	323-0269-00		RES.,FXD,FILM:6.19K OHM,1%,0.50W	75042	CECTO-6191F

¹R1434 and R1460 furnished as a unit.

Electrical Parts List—465 Service (SN B250000-up)

Ckt No.	Tektronix Part No.	Serial/Model No. Eff	Dscont	Name & Description	Mfr Code	Mfr Part Number
R1523	321-0292-00			RES.,FXD,FILM:10.7K OHM,1%,0.125W	75042	CEATO-1072F
R1524	303-0472-00			RES.,FXD,COMP:4.7K OHM,5%,1W	01121	GB4725
R1525	316-0102-00			RES.,FXD,COMP:1K OHM,10%,0.25W	01121	CB1021
R1527	315-0183-00			RES.,FXD,COMP:18K OHM,5%,0.25W	01121	CB1835
R1528	303-0223-00			RES.,FXD,COMP:22K OHM,5%,1W	01121	GB2235
R1532	315-0122-00			RES.,FXD,COMP:1.2K OHM,5%,0.25W	01121	CB1225
R1533	315-0563-00			RES.,FXD,COMP:56K OHM,5%,0.25W	01121	CB5635
R1534	307-0052-00			RES.,FXD,COMP:3 OHM,5%,0.50W	01121	EB30G5
R1537	321-0366-00			RES.,FXD,FILM:63.4K OHM,1%,0.125W	75042	CEATO-6342F
R1538	311-1226-00			RES.,VAR,NONWIR:2.5K OHM,20%,0.50W	80294	3389F-P31-252
R1539	321-0296-00			RES.,FXD,FILM:11.8K OHM,1%,0.125W	75042	CEATO-1182F
R1543	321-0966-03			RES.,FXD,FILM:40K OHM,0.25%,0.125W	75042	CEAT2-4002C
R1544	321-0603-00			RES.,FXD,FILM:15K OHM,0.25%,0.125W	75042	CEAT2-1502C
R1546	315-0102-00			RES.,FXD,COMP:1K OHM,5%,0.25W	01121	CB1025
R1547	315-0153-00			RES.,FXD,COMP:15K OHM,5%,0.25W	01121	CB1535
R1549	308-0459-00			RES.,FXD,WW:1.1 OHM,5%,3W	91637	RS2B-D1R100J
R1553	321-0775-03			RES.,FXD,FILM:45K OHM,0.25%,0.125W	75042	CEAT2-4502C
R1554	321-0774-03			RES.,FXD,FILM:4.5K OHM,0.25%,0.125W	75042	CEAT2-4501C
R1556	315-0102-00			RES.,FXD,COMP:1K OHM,5%,0.25W	01121	CB1025
R1557	315-0512-00			RES.,FXD,COMP:5.1K OHM,5%,0.25W	01121	CB5125
R1559	307-0093-00			RES.,FXD,COMP:1.2 OHM,5%,0.50W	01121	EB12G5
R1563	321-0274-00			RES.,FXD,FILM:6.98K OHM,1%,0.125W	75042	CEATO-6981F
R1564	321-0967-03			RES.,FXD,FILM:55K OHM,0.25%,0.125W	91637	MFF1816D55001C
R1565	321-0962-03			RES.,FXD,FILM:8K OHM,0.25%,0.125W	91637	MFF1816D80000C
R1566	315-0471-00			RES.,FXD,COMP:470 OHM,5%,0.25W	01121	CB4715
R1567	315-0242-00			RES.,FXD,COMP:2.4K OHM,5%,0.25W	01121	CB2425
R1569	308-0459-00			RES.,FXD,WW:1.1 OHM,5%,3W	91637	RS2B-D1R100J
R1570	311-1373-00			RES.,VAR,NONWIR:5K OHM,20%,1W	01121	10M336A
R1571	315-0302-00			RES.,FXD,COMP:3K OHM,5%,0.25W	01121	CB3025
R1581	315-0153-00			RES.,FXD,COMP:15K OHM,5%,0.25W	01121	CB1535
R1584	321-0359-00			RES.,FXD,FILM:53.6K OHM,1%,0.125W	75042	CEATO-5362F
R1585	321-0278-00			RES.,FXD,FILM:7.68K OHM,1%,0.125W	75042	CEATO-7681F
R1586	316-0104-00			RES.,FXD,COMP:100K OHM,10%,0.25W	01121	CB1041
R1587	316-0104-00			RES.,FXD,COMP:100K OHM,10%,0.25W	01121	CB1041
R1589	315-0102-00			RES.,FXD,COMP:1K OHM,5%,0.25W	01121	CB1025
R1591	315-0912-00			RES.,FXD,COMP:9.1K OHM,5%,0.25W	01121	CB9125
R1592	315-0473-00			RES.,FXD,COMP:47K OHM,5%,0.25W	01121	CB4735
R1593	315-0822-00			RES.,FXD,COMP:8.2K OHM,5%,0.25W	01121	CB8225
R1594	315-0513-00			RES.,FXD,COMP:51K OHM,5%,0.25W	01121	CB5135
R1596	315-0512-00			RES.,FXD,COMP:5.1K OHM,5%,0.25W	01121	CB5125
R1597	311-1221-00			RES.,VAR,NONWIR:50 OHM,20%,0.50W	80294	3389F-P31-500
R1598	321-0107-00			RES.,FXD,FILM:127 OHM,1%,0.125W	75042	CEATO-1270F
R1599	321-0001-00			RES.,FXD,FILM:10 OHM,1%,0.125W	75042	CEATO-10R00F
R1691	303-0150-00			RES.,FXD,COMP:15 OHM,5%,1W	01121	GB1505
R1692	321-0062-00			RES.,FXD,FILM:43.2 OHM,1%,0.125W	75042	CEATO-43R20F
R1693	323-0140-00			RES.,FXD,FILM:280 OHM,1%,0.50W	75042	CECT0-2800F
R1694	323-0140-00			RES.,FXD,FILM:280 OHM,1%,0.50W	75042	CECT0-2800F
R1695	321-0228-00			RES.,FXD,FILM:2.32K OHM,1%,0.125W	75042	CEATO-2321F
R1697	321-0201-00			RES.,FXD,FILM:1.21K OHM,1%,0.125W	75042	CEATO-1211F
R1698	315-0363-00			RES.,FXD,COMP:36K OHM,5%,0.25W	01121	CB3635
R4401	321-0068-00			RES.,FXD,FILM:49.9 OHM,1%,0.125W	75042	CEATO-49R90F
R4402	315-0301-00			RES.,FXD,COMP:300 OHM,5%,0.25W	01121	CB3015
R4403	321-0097-00			RES.,FXD,FILM:100 OHM,1%,0.125W	75042	CEATO-1000F

Electrical Parts List—465 Service (SN B250000-up)

Ckt No.	Tektronix Part No.	Serial/Model No. Eff	Dscont	Name & Description	Mfr Code	Mfr Part Number
R4404	321-0097-00			RES.,FXD,FILM:100 OHM,1%,0.125W	75042	CEATO-1000F
R4406	315-0242-00			RES.,FXD,COMP:2.4K OHM,5%,0.25W	01121	CB2425
R4408	321-0095-00			RES.,FXD,FILM:95.3 OHM,1%,0.125W	75042	CEATO-95R30F
R4409	321-0189-00			RES.,FXD,FILM:909 OHM,1%,0.125W	75042	CEATO-9090F
R4411	321-0068-00			RES.,FXD,FILM:49.9 OHM,1%,0.125W	75042	CEATO-49R90F
R4412	315-0301-00			RES.,FXD,COMP:300 OHM,5%,0.25W	01121	CB3015
R4413	321-0097-00			RES.,FXD,FILM:100 OHM,1%,0.125W	75042	CEATO-1000F
R4414	321-0097-00			RES.,FXD,FILM:100 OHM,1%,0.125W	75042	CEATO-1000F
R4416	315-0242-00			RES.,FXD,COMP:2.4K OHM,5%,0.25W	01121	CB2425
R4418	311-1237-00			RES.,VAR,NONWIR:1K OHM,10%,0.50W	80294	3386H-T07-102
R4419	321-0189-00			RES.,FXD,FILM:909 OHM,1%,0.125W	75042	CEATO-9090F
R4421	321-0089-00			RES.,FXD,FILM:82.5 OHM,1%,0.125W	75042	CEATO-82R50F
R4422	311-1278-00			RES.,VAR,NONWIR:250 OHM,10%,0.50W	80294	3226W-L58-251
R4423	315-0101-00			RES.,FXD,COMP:100 OHM,5%,0.25W	01121	CB1015
R4424	315-0101-00			RES.,FXD,COMP:100 OHM,5%,0.25W	01121	CB1015
R4425	311-1238-00			RES.,VAR,NONWIR:5K OHM,10%,0.50W	73138	72X-27-0.502K
R4427	311-1225-00			RES.,VAR,NONWIR:1K OHM,20%,0.50W	80294	3389F-P31-102
R4430	323-0147-00			RES.,FXD,FILM:332 OHM,1%,0.50W	75042	CECTO-3320F
R4431	317-0220-00			RES.,FXD,COMP:22 OHM,5%,0.125W	01121	BB2205
R4432	315-0101-00			RES.,FXD,COMP:100 OHM,5%,0.25W	01121	CB1015
R4433	323-0118-00			RES.,FXD,FILM:165 OHM,1%,0.50W	75042	CECTO-1650F
R4434	315-0100-00			RES.,FXD,COMP:10 OHM,5%,0.25W	01121	CB1005
R4435	321-0059-00			RES.,FXD,FILM:40.2 OHM,1%,0.125W	75042	CEATO-40R20F
R4436	317-0100-00			RES.,FXD,COMP:10 OHM,5%,0.125W	01121	BB1005
R4437	317-0751-00			RES.,FXD,COMP:750 OHM,5%,0.125W	01121	BB7515
R4438	311-1260-00			RES.,VAR,NONWIR:250 OHM,10%,0.50W	73138	62PT-345-0
R4440	323-0147-00			RES.,FXD,FILM:332 OHM,1%,0.50W	75042	CECTO-3320F
R4441	317-0220-00			RES.,FXD,COMP:22 OHM,5%,0.125W	01121	BB2205
R4442	315-0101-00			RES.,FXD,COMP:100 OHM,5%,0.25W	01121	CB1015
R4443	323-0118-00			RES.,FXD,FILM:165 OHM,1%,0.50W	75042	CECTO-1650F
R4444	315-0100-00			RES.,FXD,COMP:10 OHM,5%,0.25W	01121	CB1005
R4445	321-0059-00			RES.,FXD,FILM:40.2 OHM,1%,0.125W	75042	CEATO-40R20F
R4448	315-0622-00			RES.,FXD,COMP:6.2K OHM,5%,0.25W	01121	CB6225
R4449	321-0193-00			RES.,FXD,FILM:1K OHM,1%,0.125W	75042	CEATO-1001F
R4451	315-0820-00			RES.,FXD,COMP:82 OHM,5%,0.25W	01121	CB8205
R4452	315-0301-00			RES.,FXD,COMP:300 OHM,5%,0.25W	01121	CB3015
R4453	323-0157-00			RES.,FXD,FILM:422 OHM,1%,0.50W	75042	CECTO-4220F
R4462	321-0205-00			RES.,FXD,FILM:1.33K OHM,1%,0.125W	75042	CEATO-1331F
R4463	321-0219-00			RES.,FXD,FILM:1.87K OHM,1%,0.125W	75042	CEATO-1871F
R4464	321-0093-00			RES.,FXD,FILM:90.9 OHM,1%,0.125W	75042	CEATO-90R90F
R4465	321-0126-00			RES.,FXD,FILM:200 OHM,1%,0.125W	75042	CEATO-2000F
R4466	311-1226-00			RES.,VAR,NONWIR:2.5K OHM,20%,0.50W	80294	3389F-P31-252
R4468	321-0031-00			RES.,FXD,FILM:20.5 OHM,1%,0.125W	75042	CEATO-20R50F
R4469	323-0068-00			RES.,FXD,FILM:49.9 OHM,1%,0.50W	75042	CECTO-49R90F
R4474	321-0093-00			RES.,FXD,FILM:90.9 OHM,1%,0.125W	75042	CEATO-90R90F
R4475	321-0126-00			RES.,FXD,FILM:200 OHM,1%,0.125W	75042	CEATO-2000F
R4478	321-0031-00			RES.,FXD,FILM:20.5 OHM,1%,0.125W	75042	CEATO-20R50F
R4480	315-0100-00			RES.,FXD,COMP:10 OHM,5%,0.25W	01121	CB1005
R4481	301-0820-00			RES.,FXD,COMP:82 OHM,5%,0.50W	01121	EB8205
R4482	315-0820-00			RES.,FXD,COMP:82 OHM,5%,0.25W	01121	CB8205
R4483	310-0700-00			RES.,FXD,WW:430 OHM,1%,WW	80009	310-0700-00
R4485	301-0100-00			RES.,FXD,COMP:10 OHM,5%,0.50W	01121	EB1005
R4487	315-0180-00			RES.,FXD,COMP:18 OHM,5%,0.25W	01121	CB1805
R4491	301-0820-00			RES.,FXD,COMP:82 OHM,5%,0.50W	01121	EB8205

Electrical Parts List—465 Service (SN B250000-up)

Ckt No.	Tektronix Part No.	Serial/Model No. Eff Dscont	Name & Description	Mfr Code	Mfr Part Number
R4492	315-0820-00		RES., FXD, COMP: 82 OHM, 5%, 0.25W	01121	CB8205
R4493	310-0700-00		RES., FXD, WW: 430 OHM, 1%, WW	80009	310-0700-00
R4497	315-0180-00		RES., FXD, COMP: 18 OHM, 5%, 0.25W	01121	CB1805
R4498	315-0100-00		RES., FXD, COMP: 10 OHM, 5%, 0.25W	01121	CB1005
R4499	315-0100-00		RES., FXD, COMP: 10 OHM, 5%, 0.25W	01121	CB1005
RT39	307-0124-00		RES., THERMAL: 5K OHM, 10%	50157	1D1618
RT131	307-0124-00		RES., THERMAL: 5K OHM, 10%	50157	1D1618
RT231	307-0124-00		RES., THERMAL: 5K OHM, 10%	50157	1D1618
RT422	307-0181-00		RES., THERMAL: 100K OHM, 10%, 4MW/DEG C	14193	2J05-104K
RT557	307-0124-00		RES., THERMAL: 5K OHM, 10%	50157	1D1618
RT657	307-0124-00		RES., THERMAL: 5K OHM, 10%	50157	1D1618
RT1230	307-0122-00		RES., THERMAL: 50 OHM, 10%	50157	3D1515
RT1696	307-0124-00		RES., THERMAL: 5K OHM, 10%	50157	1D1618
RT4448	307-0181-00		RES., THERMAL: 100K OHM, 10%, 4MW/DEG C	14193	2J05-104K
S5 ¹					
S10	105-0342-01		DRUM, CAM SWITCH: VOLTS/DIV CH 1	80009	105-0342-01
S55 ¹					
S60	105-0342-01		DRUM, CAM SWITCH: VOLTS/DIV CH 2	80009	105-0342-01
S112 ²					
S212 ³					
S225	260-1208-00		SWITCH, PUSH: INVERT	71590	2KAB010000-359
S338A	105-0423-00		ACTUATOR, SWITCH: BANDWIDTH LIMIT	80009	105-0423-00
S338B	105-0421-00		ACTUATOR, SWITCH: TRIG VIEW	80009	105-0421-00
S350	260-1424-01		SWITCH, PUSH: VERT MODE	71590	2KBC050000-684
S400	260-1421-00		SWITCH, PUSH: BEAM FIND	80009	260-1421-00
S510	105-0401-00		ACTUATOR, SWITCH: B (DLY'D) SOURCE	80009	105-0401-00
S515	105-0399-00		ACTUATOR, SWITCH: B (DLY'D) COUPLING	80009	105-0399-00
S530 ⁴					
S610	105-0400-00		ACTUATOR, SWITCH: A SOURCE	80009	105-0400-00
S615	105-0399-00		ACTUATOR, SWITCH: A COUPLING	80009	105-0399-00
S630 ⁵					
S1100	260-1422-00		SWITCH, PUSH: TRIG MODE	71590	2KBC030000-594
S1120	260-1423-00		SWITCH, PUSH: HORIZ DISPLAY	71590	2KBC040000-593
S1140 ⁶					
S1150	263-1086-00		ACTR ASSY, CAM S: TIME/CM	80009	263-1086-00
S1155A, B ⁷					
S1239	260-1208-00		SWITCH, PUSH: DPDT	71590	2KAB010000-359
S1501	260-0834-00		SWITCH, TOGGLE: DPDT, 5A, 125VAC, 0.25-40 THD	09353	7201-SN
S1502	260-0638-00		SW, THERMOSTATIC: 10A, 240V, OPEN 75 DEG C	93410	S3530
S1503	260-1300-01		SWITCH, SLIDE: DPDT, 3A, 125V	82389	46206LFE
T354	120-0366-00		XFMR, TOROID: 2 WINDINGS	80009	120-0366-00
T1420	120-0800-01		XFMR, PWR, SDN & : MOLDED	80009	120-0800-01
T1501	120-0798-01		XFMR, PWR, STPDN:	80009	120-0798-01
U440	155-0115-00		MICROCIRCUIT, LI: HYBRID	80009	155-0115-00
U540	155-0032-00		MICROCIRCUIT, LI: ML, PRE-AMPLIFIER	80009	155-0032-00
U640	155-0032-00		MICROCIRCUIT, LI: ML, PRE-AMPLIFIER	80009	155-0032-00
U870	155-0049-01		MICROCIRCUIT, DI: MONOLITHIC, SWEEP CONTROL	80009	155-0049-01
U1432	152-0552-00		SEMICOND DEVICE: VOLTAGE MULTIPLIER	80009	152-0442-00
U1524	156-0158-00		MICROCIRCUIT, LI: DUAL OPERATIONAL AMPLIFIER	18324	S5558V
U1554	156-0158-00		MICROCIRCUIT, LI: DUAL OPERATIONAL AMPLIFIER	18324	S5558V
U1690	156-0281-00		MICROCIRCUIT, LI: 4 TRANSISTOR ARRAY	80009	156-0281-00

¹See Mechanical Parts List for replacement parts.

²Furnished as a unit with R112.

³Furnished as a unit with R212.

⁴Furnished as a unit with R530.

⁵Furnished as a unit with R630.

⁶Furnished as a unit with R1140.

⁷Furnished as a unit with R1155.

Electrical Parts List—465 Service (SN B250000-up)

Ckt No.	Tektronix Part No.	Serial/Model No. Eff Dscont	Name & Description	Mfr Code	Mfr Part Number
V1440	154-0676-10		ELECTRON TUBE:CRT	80009	154-0676-10
VR21	152-0166-00		SEMICON D DEVICE:ZENER,0.4W,6.2V,5%	81483	69-9035
VR71	152-0166-00		SEMICON D DEVICE:ZENER,0.4W,6.2V,5%	81483	69-9035
VR129	152-0166-00		SEMICON D DEVICE:ZENER,0.4W,6.2V,5%	81483	69-9035
VR229	152-0166-00		SEMICON D DEVICE:ZENER,0.4W,6.2V,5%	81483	69-9035
VR875	152-0278-00		SEMICON D DEVICE:ZENER,400MA,3V,5%	07910	1N4372A
VR896	152-0227-00		SEMICON D DEVICE:ZENER,0.4W,6.2V,5%	81483	69-6585
VR1039	152-0166-00		SEMICON D DEVICE:ZENER,0.4W,6.2V,5%	81483	69-9035
VR1099	152-0166-00		SEMICON D DEVICE:ZENER,0.4W,6.2V,5%	81483	69-9035
VR1145	152-0395-00		SEMICON D DEVICE:ZENER,0.4W,4.3V,5%	07910	1N749A
VR1146	152-0166-00		SEMICON D DEVICE:ZENER,0.4W,6.2V,5%	81483	69-9035
VR1155	152-0278-00		SEMICON D DEVICE:ZENER,400MA,3V,5%	07910	1N4372A
VR1289	152-0166-00		SEMICON D DEVICE:ZENER,0.4W,6.2V,5%	81483	69-9035
VR1428	152-0289-00		SEMICON D DEVICE:ZENER,0.4W,180V,5%	07910	1N991B
VR1484	152-0286-00		SEMICON D DEVICE:ZENER,0.4W,75V,5%	04713	1N982B
VR1515	152-0268-00		SEMICON D DEVICE:ZENER,0.4W,56V,5%	04713	1N979B
VR1522	152-0411-00		SEMICON D DEVICE:ZENER,0.25W,9V,5%	04713	1N937
VR1525	152-0283-00		SEMICON D DEVICE:ZENER,0.4W,43V,5%	04713	1N976B
VR1526	152-0281-00		SEMICON D DEVICE:ZENER,0.4W,22V,5%	04713	1N969B
VR1533	152-0304-00		SEMICON D DEVICE:ZENER,0.4W,20V,5%	04713	1N968B
VR1570	152-0127-00		SEMICON D DEVICE:ZENER,0.4W,7.5V,5%	04713	1N755A
VR4464	152-0195-00		SEMICON D DEVICE:ZENER,0.4W,5.1V,5%	81483	69-6512
VR4481	152-0195-00		SEMICON D DEVICE:ZENER,0.4W,5.1V,5%	81483	69-6512
VR4491	152-0195-00		SEMICON D DEVICE:ZENER,0.4W,5.1V,5%	81483	69-6512

OPTION INFORMATION

Your instrument may be equipped with one or more options. This section describes those options, or directs the reader to where the option is documented.

			Pages
Option 4	EMI Environmental:	Described in this section.	2
Option 5	TV Sync Separator:	Documentation is available and may be ordered separately. Order 465 Option 5 insert.	
Option 7*	EXT DC Operation:	Described in this section.	12
Option 78	P11 Phosphor:	Described in this section.	1

*Instruments containing DM 43 or DM 40 do not have Option 7 available.

OPTION 4

INTRODUCTION

This section describes the features of Option 4 as it pertains to the 465 Oscilloscope. This circuitry modifies the instrument to meet additional conducted and radiated interference requirements over the frequency range of 150 kHz to 25 MHz (conducted) and 150 kHz to 1 GHz (radiated).

The following additions and changes were made to the standard circuitry to meet the specification requirements.

EMI filter (FL1501) added in series with the input power cord.

Cathode ray tube mesh filter installed to minimize crt faceplate radiation.

Four signal-output bnc connectors on the rear plenum chamber changed to a type that improves shielding of the connected signal leads.

Capacitors added across the transformer secondary windings.

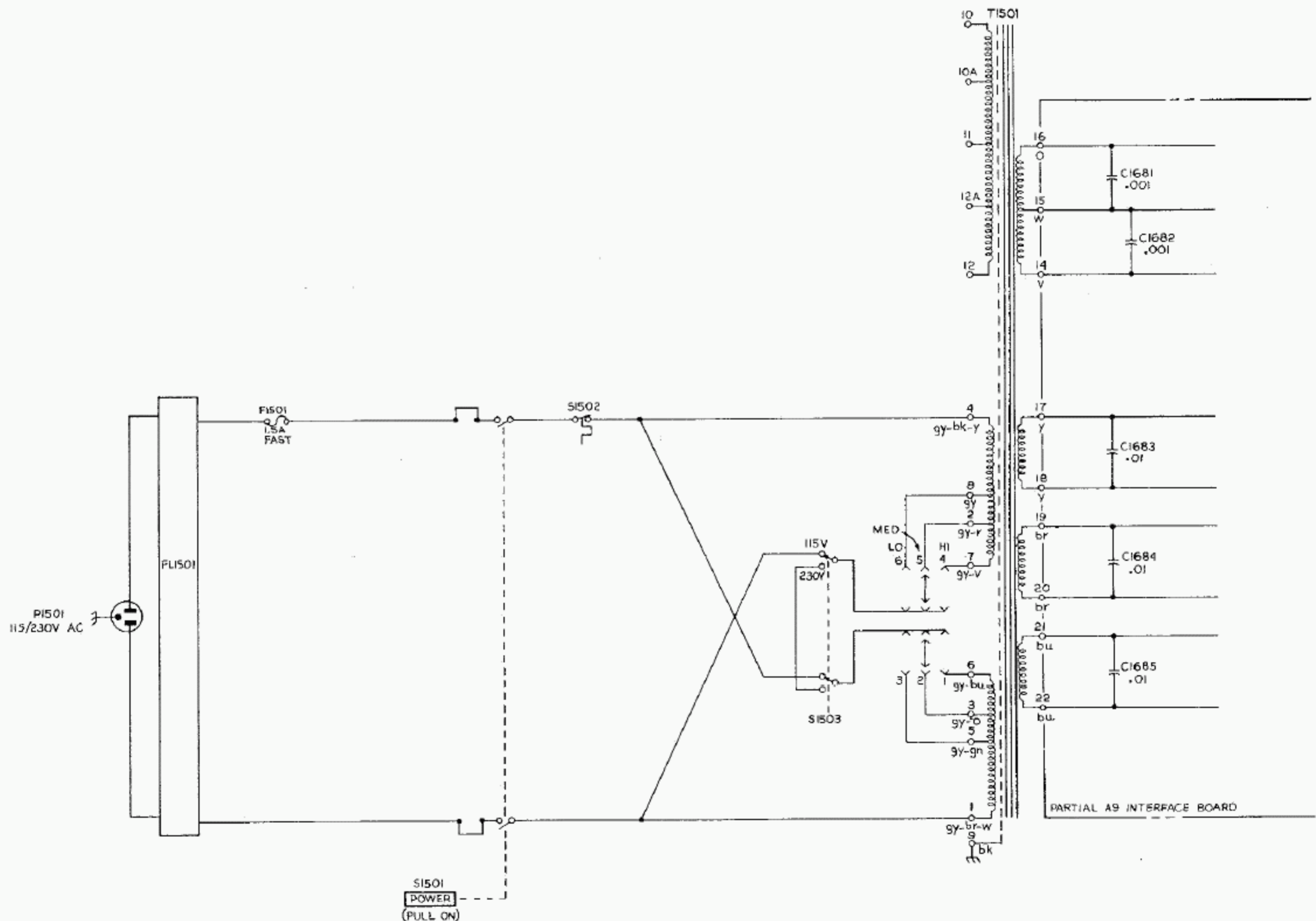

Fig. OPTION 4-1. 465 Option 4 primary winding with power line filter.

OPTION 4

REPLACEABLE PARTS LIST

Ckt No.	Tektronix Part No.	Serial/Model No. Eff	Dscont	Name & Description	Mfr Code	Mfr Part Number
---------	--------------------	----------------------	--------	--------------------	----------	-----------------

ELECTRICAL

C1681	283-0000-00			CAP.,FXD,CER DI:0.001UF,+100-0%,500V	72982	831-516E102P
C1682	283-0000-00			CAP.,FXD,CER DI:0.001UF,+100-0%,500V	72982	831-516E102P
C1683	283-0003-00			CAP.,FXD,CER DI:0.01UF,+80-20%,150V	72982	855-547E103Z
C1684	283-0003-00			CAP.,FXD,CER DI:0.01UF,+80-20%,150V	72982	855-547E103Z
C1685	283-0003-00			CAP.,FXD,CER DI:0.01UF,+80-20%,150V	72982	855-547E103Z
FL1501	119-0376-01			FILTER,RAD INT:2 X 3A,250V,400 HZ	80009	119-0376-01
J165	131-1315-00			CONNECTOR,RCPT,:BNC,FEMALE	80009	131-1315-00
J1318	131-1315-00			CONNECTOR,RCPT,:BNC,FEMALE	80009	131-1315-00
J1338	131-1315-00			CONNECTOR,RCPT,:BNC,FEMALE	80009	131-1315-00
J1450	131-1315-00			CONNECTOR,RCPT,:BNC,FEMALE	80009	131-1315-00

MECHANICAL

Fig. & Index No.	Tektronix Part No.	Serial/Model No. Eff	Dscont	Qty	1	2	3	4	5	Name & Description	Mfr Code	Mfr Part Number
	119-0376-01			1						FILTER,RAD INT:(SEE FL1501 EPL) (ATTACHING PARTS)	80009	119-0376-01
	211-0038-00			1						SCREW,MACHINE:4-40 X 0.312"100 DEG,FLH STL	83385	OBD
	210-0586-00			1						NUT,PLAIN,EXT W:4-40 X 0.25 INCH,STL - - - * - - -	78189	OBD
	131-0707-00			1						CONTACT,ELEC:0.48"L,22-26 AWG WIRE	22526	47439
	131-0708-00			1						CONTACT,ELEC:0.48"L,28-32 AWG WIRE	22526	47437
	131-1310-00			1						CONTACT,ELEC:MESH FILTER GROUND	80009	131-1310-00
	-----			4						CONNECTOR,RCPT:(SEE J165,1318,1338,1450 EPL)		
	179-2162-00			1						WIRING HARNESS:	80009	179-2162-00
	210-0774-00			2						EYELET,METALLIC:0.152 OD X 0.245 INCH L,BRS	80009	210-0774-00
	210-0775-00			2						EYELET,METALLIC:0.126 OD X 0.23 INCH L,BRS	80009	210-0775-00
	378-0726-00			1						FILTER,MESH,CRT:	80009	378-0726-00

OPTION 7

Option 7 is a dc to ac inverter that permits Tektronix Oscilloscopes to operate on 12 or 24 V dc with no performance deterioration. Circuitry is provided to protect against damage due to connection of 24 V when in the 12 V mode of operation.

The 24-volt external input permits use with conventional dc power (marine and aircraft).

Option 7 is an integral part of the oscilloscope. The modified oscilloscope has a three-position voltage input selection slide switch (visible through the right-hand side panel) at the rear of the line voltage selector switch. A dc input connector is located below the fan cover on the rear panel.

SPECIFICATIONS

AC Requirements

No increase in ac requirements over those of oscilloscopes not having Option 7.

DC Requirements

11.5 to 14 volts or 22 to 28 volts. 11.5-volt operation excludes graticule light operation and Option 5. Operating range may be extended to 15 volts or 30 volts with a series dropping resistor. Maximum elevation for + or - power lead is 50 V with respect to oscilloscope chassis ground.

Temperature

The same operating and non-operating range as the oscilloscope without Option 7.

SAFETY CONSIDERATIONS

Option 7 becomes a part of the modified instrument. The safety considerations for the unmodified instrument apply.

FUNCTION OF CONTROLS AND CONNECTORS

Mode Switch¹

AC Applies ac power to the oscilloscope power switch.

¹Be sure that the 1106 Line Selector switch is set to the correct line voltage for proper battery charging.

DC 12 Permits 12 V operation of the instrument from an external 12 V source.

DC 24 Permits 24 V operation of the instrument from either an external 24 V power source or from the 1106 Power Supply, which may be mechanically attached to the oscilloscope.

DC Input Connector

Option 7 mode switch and dc input connector are located on the modified oscilloscope.

OPERATION AND INSPECTION

Set the oscilloscope and Option 7 for the power source available as listed.

TABLE 1

Power Source	Oscilloscope Line Selector	Option 7 Mode Switch
115 V AC	115	AC
230 V AC	230	AC
12 V DC		12
24 V DC		24
1106 ¹		24

Turn the oscilloscope on. Check that the oscilloscope operates properly on any of the listed power sources that may be available.

Connect the oscilloscope frame to a ground (earth) reference before using.

CIRCUIT DESCRIPTION

Option 7 is a dc to ac inverter. It operates on 12 or 24 V dc. The circuit description is for 24 V operation unless noted otherwise. Refer to the schematic diagrams (Fig. Option 7-2 and 7-3) throughout the detailed circuit description.

The operating frequency of the inverter is approximately 400 Hz.

Simplified Block Diagram

See Fig. Option 7-1. The dc source is applied to the turn-off level circuit, the start circuit and the primary of T1501. If the dc source is above the level set by Turn-Off Level Adjustment R1613, the turn-off circuit does not operate.

The start circuit provides a large current surge through T1631 secondary to the bases of Q1652, Q1662, Q1654 and Q1664. This starts the inverter.

The turn-off circuit is activated in two ways. In 24 V operation, Q1622 is turned on by the source voltage dropping below 22 V. In 12 V mode of operation, Q1626 is turned on by the accidental application of 24 V dc.

Turn-Off Level Circuit

For the following description, refer to Fig. Option 7-2.

The voltage reference for the base of Q1606 is set by R1604, VR1604 and VR1605 for about 9.1 V. This establishes the junction of R1607 and the emitters of Q1606 and Q1608 at about 9.7 V. C1605 helps to hold the 9.1 V level, preventing inverter transients from activating the turn-off circuit and prevents Q1608 from turning on when the inverter is started. This allows the power source time to recover after providing the initial-start surge.

Source voltages higher than 22 V dc cause increased current through R1607, Q1606 and R1609. Q1608 is kept cut off by the increased voltage across R1609 and the resulting change across divider R1611-R1613-R1614. This permits no current through R1617. Since R1617 furnishes bias to Q1622, the transistor is cut off. This permits the collector of Q1622 and the rest of the turn-off circuit to rise to a voltage determined by the inverter circuit and the dc source voltage. The collector of Q1622 may be about 24 V (with respect to -dc) with a 12 V dc source and about 36 V with a 24 V dc source.

If the dc source voltage drops to less than 22 V, the current through divider R1609, R1611, R1613 and R1614 is decreased. Q1608 conducts, taking current from Q1606, and causing less drop across R1609. This makes Q1608 conduct more and Q1606 is cut off. Current flow through R1617 turns Q1622 on. Q1622 saturates, dropping its collector voltage to about 0.2 V. P1618 limits the maximum base current of Q1622.

During 12 V dc operation, there is no current flow through VR1604 and VR1605, since their series rating, about 18 volts, exceeds the applied voltage. The base current of Q1606, through R1605, turns Q1606 on enough to take all the current through R1607, which causes Q1608 to be cut off.

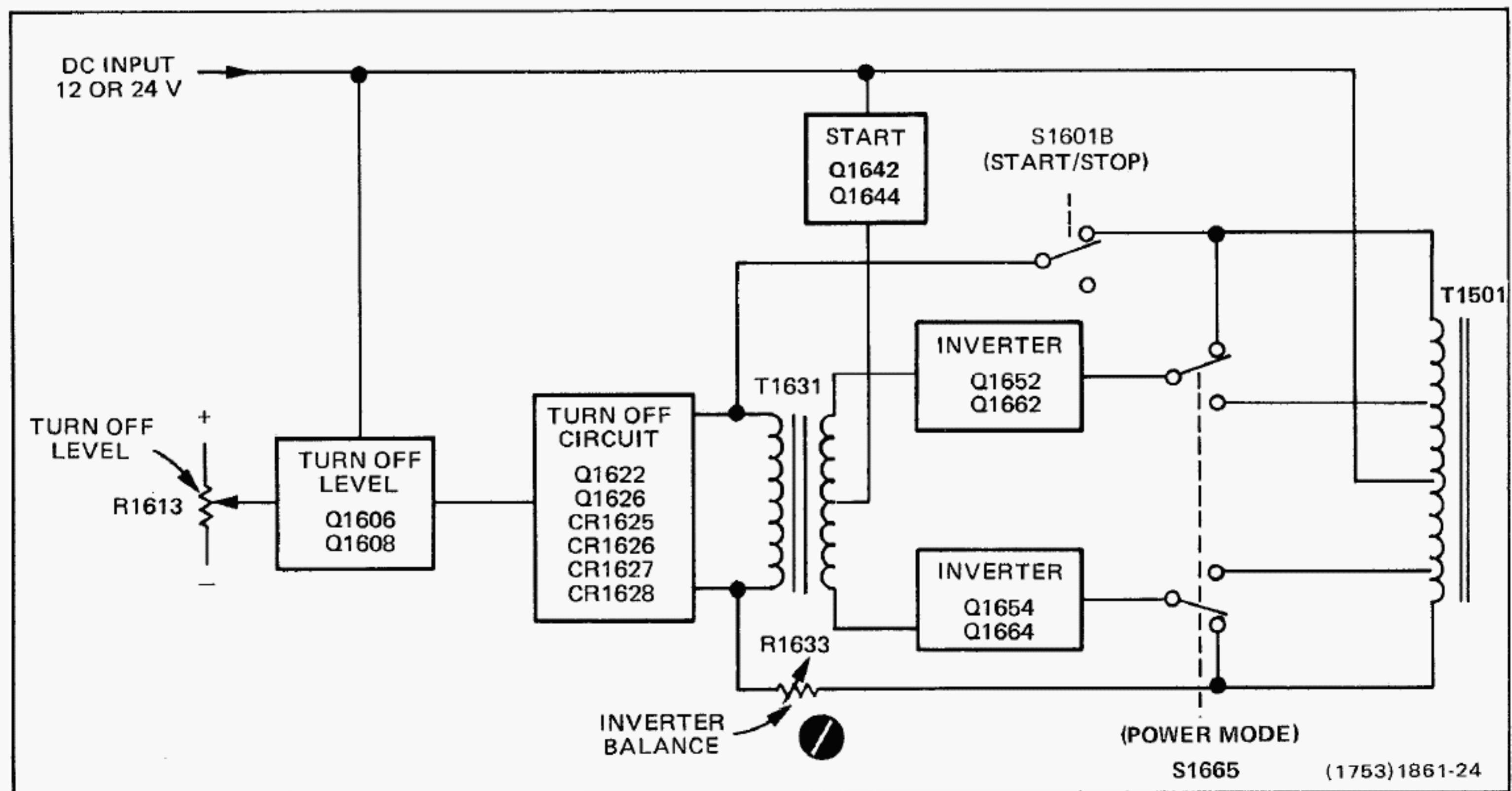

Fig. Option 7-1. Option 7 simplified block diagram.

Turn-Off Circuit

Q1622 is off under normal operating conditions until the dc source drops below 22 V and causes Q1622 to conduct. Q1622 does not conduct during 12 V dc operation, since the turn-off level circuit is disabled. CR1625, CR1626, CR1627, and CR1628 form a bridge rectifier. The inverter waveform is rectified to provide operating power for the turn-off circuit. C1626 filters the inverter spikes to keep them from firing Q1626 (scr). R1623 prevents C1626 from charging to the peak-to-peak inverter spikes.

Q1622 saturates when it is turned on. C1622 provides the high current path for feedback current via CR1625 or CR1626. Once the inverter is shut down, R1622 establishes a path to discharge C1622.

If 24 V dc is accidentally applied when the mode switch is in the 12 V position, transformer T1501 attempts to produce two times the correct feedback. This is sufficient to cause VR1622 to conduct. VR1622 provides the firing current for the scr, Q1626. Scr Q1626 fires and shorts out the bridge rectifier and the primary of T1631, stopping the inverter. R1625 prevents Q1626 from being fired by inverter noise. R1624 and C1626 provide holding current for Q1626, keeping it conducting until the surge created by the over-voltage conditions have terminated. CR1624 permits rapid charging of C1626.

Start Circuit

When S1601 is closed, the external dc source is applied to C1614, VR1641, and R1645. The initial surge is coupled to Q1642 through C1614, VR1639, and R1641. Transistor Q1642 saturates until C1614 charges through R1639 to the value determined by VR1639 and the base-emitter junction of Q1642 (about 5.7 volts), then Q1642 is cut off. R1641 limits the base current in Q1642. Zener diode VR1639, once C1614 is charged, makes Q1642 insensitive to input variations. R1642 limits Q1642 collector current. Q1644, R1645, and VR1641 provide a constant current during the time Q1642 is saturated, regardless of the dc source voltage. CR1643 is reverse biased by this starting current. The starting current is applied to the inverter transistors through T1631.

Inverter Circuit

The starting surge is applied to the bases of Q1652, Q1662, Q1654, and Q1664 through T1631, R1652, R1662, R1654, and R1664. Since the transistors do not have identical parameters, one pair will conduct before the other, and start the inverter. Operating base current is provided through CR1643.

R1626, R1631, and T1631 primary and secondary are the main frequency-determining components for the

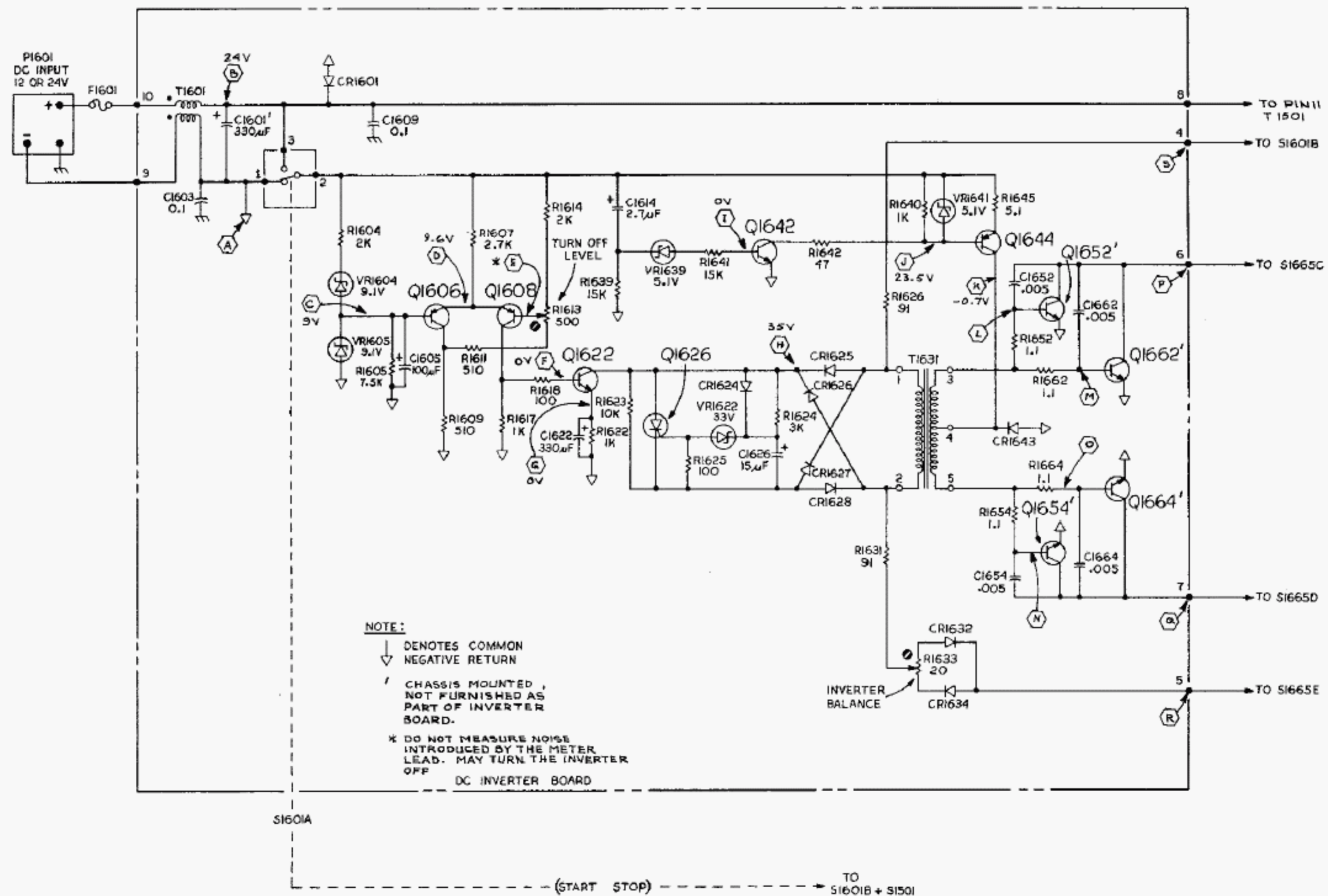

Fig. Option 7-2. 465 Option 7 DC Inverter.

Options—465 Service (SN B250000 & up)

inverter. Four base resistors, R1652, R1662, R1654, and R1664, distribute the drive evenly between the four transistors. C1652, C1662, C1654 and C1664 degenerate the high frequency response and reduce transients.

Feedback to maintain inverter operation is provided from T1501 primary to T1631 primary through R1626, R1631, R1633, CR1632 and CR1634. R1626 and R1631 provide frequency stability and current limiting. R1633, CR1632, and CR1634 compensate for differences in transistors and components. CR1632 and CR1634 conduct during different inverter half-cycles and permit R1633 to balance the drive to T1501.

C1681, C1682, C1683, C1684, and C1685 are added to the secondary of T1501 with Option 7 to provide optimum reduction of transients during inverter operation.

DC Input

External power is applied through P1601. CR1601 is normally reverse biased. If the wrong polarity external power is applied, CR1601 becomes forward biased and blows fuse F1601. Low-pass network T1601, C1601,

C1603, and C1609 is a filter to reduce transients to the dc source.

Start-Stop Switch

S1601, Section A in the off (stop) position discharges the capacitors in the turn-off and start circuits. This ensures the correct time constants when S1601 is changed to the on (start) position. In the start position, the dc input is applied to the inverter circuitry by S1601, Section A. At the same time S1601, section B is closed, completing the feedback loop for the inverter transistors, S1601, section B stops the inverter in the off position by opening the feedback loop between T1501 and T1631.

Power-Mode Switch (S1665)

See Fig. Option 7-3. Sections A and F connect filter C1671 and R1671 to T1501 during 12 or 24 V operation to reduce converter transients. Sections C and D select either transformer terminals 10A and 12A or 10 and 12, to provide the same secondary output when operating on 12 or 24 V. Sections B and E connect transformer terminals 10 and 12 to S1665, C and D, and to the inverter feedback circuit during both 12 and 24 V operation.

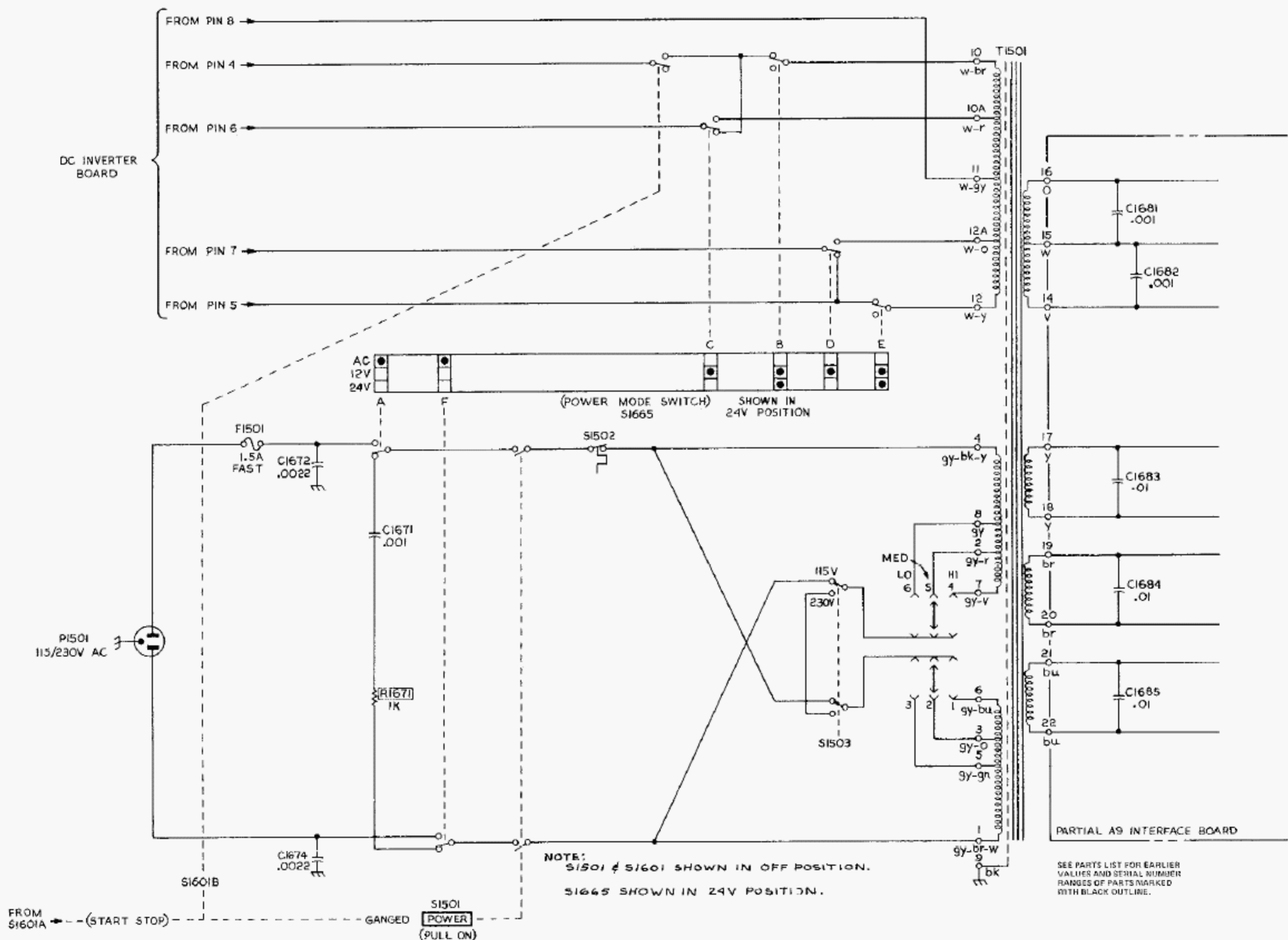

Fig. Option 7-3. 465 Option 7 primary winding.

MAINTENANCE

Obtaining Replacement Parts

STANDARD PARTS. All electrical and mechanical part replacements for Option 7 can be obtained through your local Tektronix Field Office or representative. However, many of the standard electronic components can be obtained locally in less time than is required to order them from Tektronix, Inc. Before purchasing or ordering replacement parts, check the parts list for value, tolerance, rating and description.

SPECIAL PARTS. In addition to the standard electronic components, some special components are used in Option 7. These components are manufactured or selected by Tektronix Inc., to meet specific performance requirements, or are manufactured for Tektronix, Inc., in accordance with our specifications. Most of the mechanical parts used in this instrument have been manufactured by Tektronix, Inc. Order all special parts directly from your local Tektronix Field Office or representative.

ORDERING PARTS. When ordering replacement parts from Tektronix, Inc., include the following information:

1. Instrument type.
2. Instrument serial number.
3. A description of the part (if electrical, include the circuit number).
4. Tektronix part number.

Circuit Board Chassis Removal

The circuit board is mounted on a small chassis located between the power transformer and the crt shield. To remove the chassis, remove three screws. Two thread-forming screws are located at the top of the chassis. One screw is at the bottom of the chassis and is removed from the right-hand side by going just below the power transformer.

CALIBRATION

Option 7 may be calibrated without removing it from the oscilloscope.

The reference letters (A), (B), etc., refer to points indicated on the schematic and circuit board illustrations.

Equipment Required

DC VOLTMETER. 22 V to 28 V.

TEST OSCILLOSCOPE. Used to verify the inverter balance adjustment. If the instrument under test and Option 7 are operational and the power source has a negative ground, they may be used as the test oscilloscope for this check.

DC POWER SOURCE. Voltage from 22 V to 28 V and from 11.5 V to 14 V. A source voltage of less than 22 volts will turn off Option 7 when it is operating in the 24 V mode. Starting current in 24 V mode is approximately 4 to 10 A. The dc source must be capable of handling this surge without dropping to 22 V or less. The 12 V starting surge is approximately 15 A.

NOTE

Option 7 is calibrated at the factory using a power supply (having the specifications listed first under the equipment required list). This permits the most accurate setting of the turn-off volts and inverter balance adjustments. Because this type of power supply may not be available, several alternative possibilities are given. The alternate power supplies have drawbacks, including voltage stability vs. time with high discharge rates. See Fig. Option 7-4.

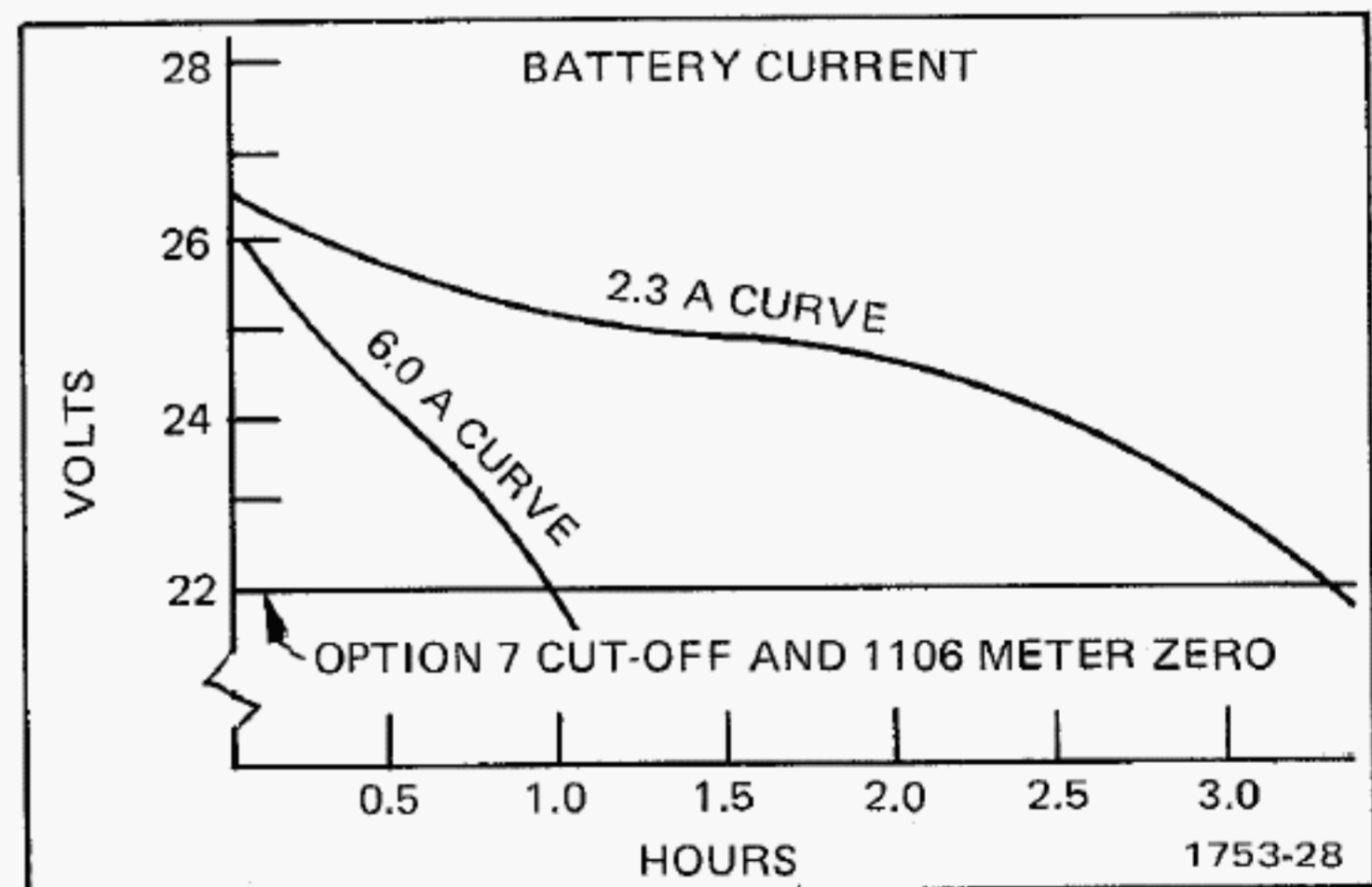

Fig. Option 7-4. Typical battery pack discharge curves.

1. Variable power supply with the aforementioned capabilities.
2. Variable power supply with an adequate current rating, in series with items 4 or 5.

Options—465 Service (SN B250000 & up)

3. 1106 Power Supply battery pack.²
4. Two 12-volt wet-cell storage batteries, in series, tapped at 20, 22, or 24 V.³
5. 18 to 23 Ni Cd cells, 4.0 amp hr (D cells) or greater, furnishing 20 to 28 V.³

CAUTION

This procedure is for an external dc source with the negative lead at ground potential (negative ground system).

Operating Range

a. Connect the dc source to the oscilloscope equipped with Option 7. Operate the oscilloscope in the 24 V mode. Connect the voltmeter between fuse, F1601 (B) and the common negative return (A). Vary the dc source from 28 V to 22 V.

CHECK—Oscilloscope should operate over the voltage range.

b. Change the dc source to 12 V. Operate the oscilloscope in the 12 V mode. Vary the dc source from 14 V to 11.5 V.

CHECK—Oscilloscope should operate over the voltage range.

²To set the turn-off level, the battery is charged above the cut-off point (22 V). An oscilloscope is connected and the battery allowed to discharge while its voltage is being monitored. As it reaches 22 V the turn-off point is set to cut off Option 7. The turn-off point on Option 7 approximately coincides with the meter zero on the 1106.

³This does not permit accurate adjustment of the turn-off level. Ni Cd batteries can be used, following the technique used for item 3.

Inverter Balance

NOTE

If the major oscilloscope use is with a 12-volt source, do this step while operating the oscilloscope and dc source on 12 volts.

Operate the oscilloscope in the 24 V mode. Set the dc source to 24 V. Connect the test oscilloscope between C1601 (C) and the common negative return (A).

CHECK—Signal should be flat. See Fig. Option 7-5.

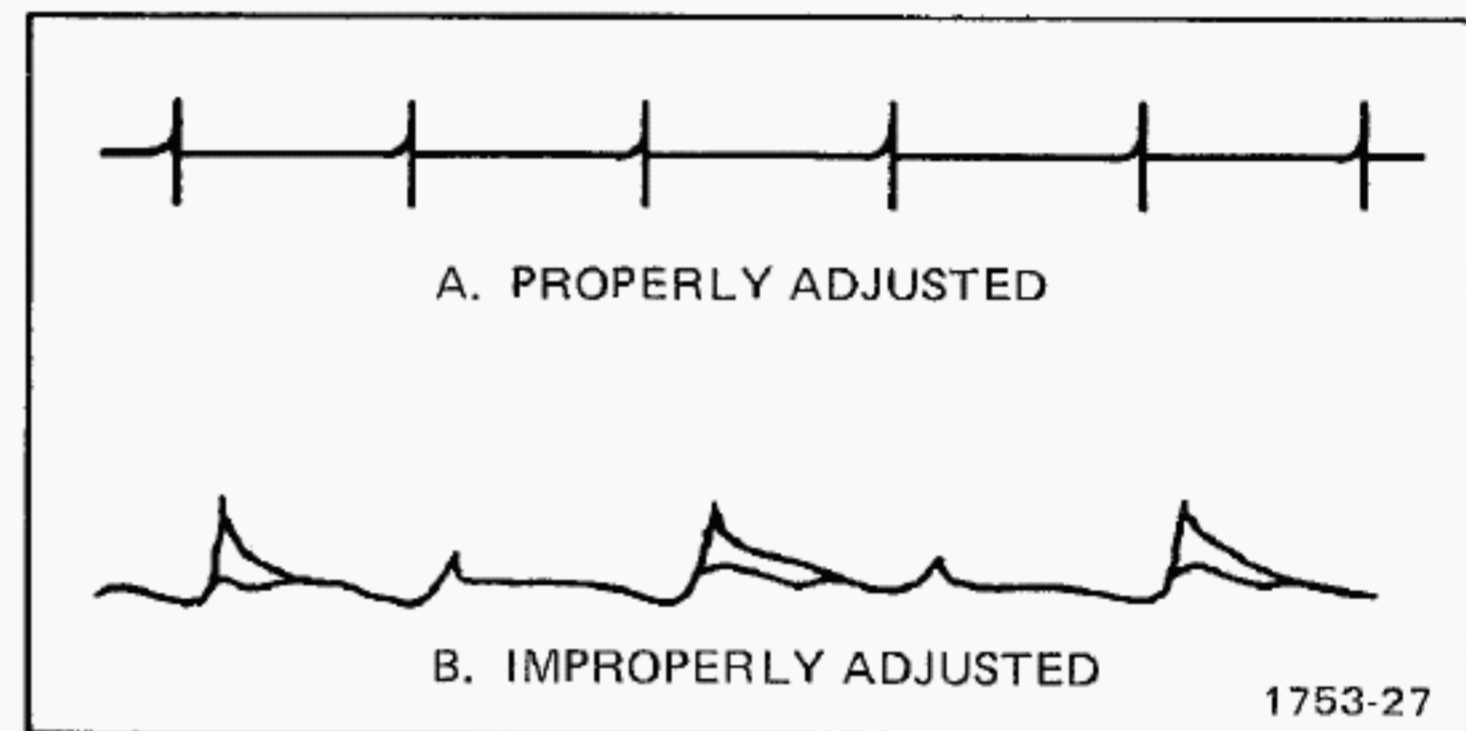

Fig. Option 7-5. Inverter Balance.

ADJUST—Inverter Balance (R1633) for the flattest signal.

NOTE

There is a slow drift (about a second) after the inverter balance adjustment has been moved. This is due to transistor characteristics and will require a slight Inverter Balance readjustment.

A very close approximation of the preceding method can be obtained by setting the inverter balance control for the minimum sound coming from the inverter.

Turn-Off Level

Set the dc source for 21.8 V.

ADJUST—Turn-Off Level (R1613) slowly until Option 7 turns off.

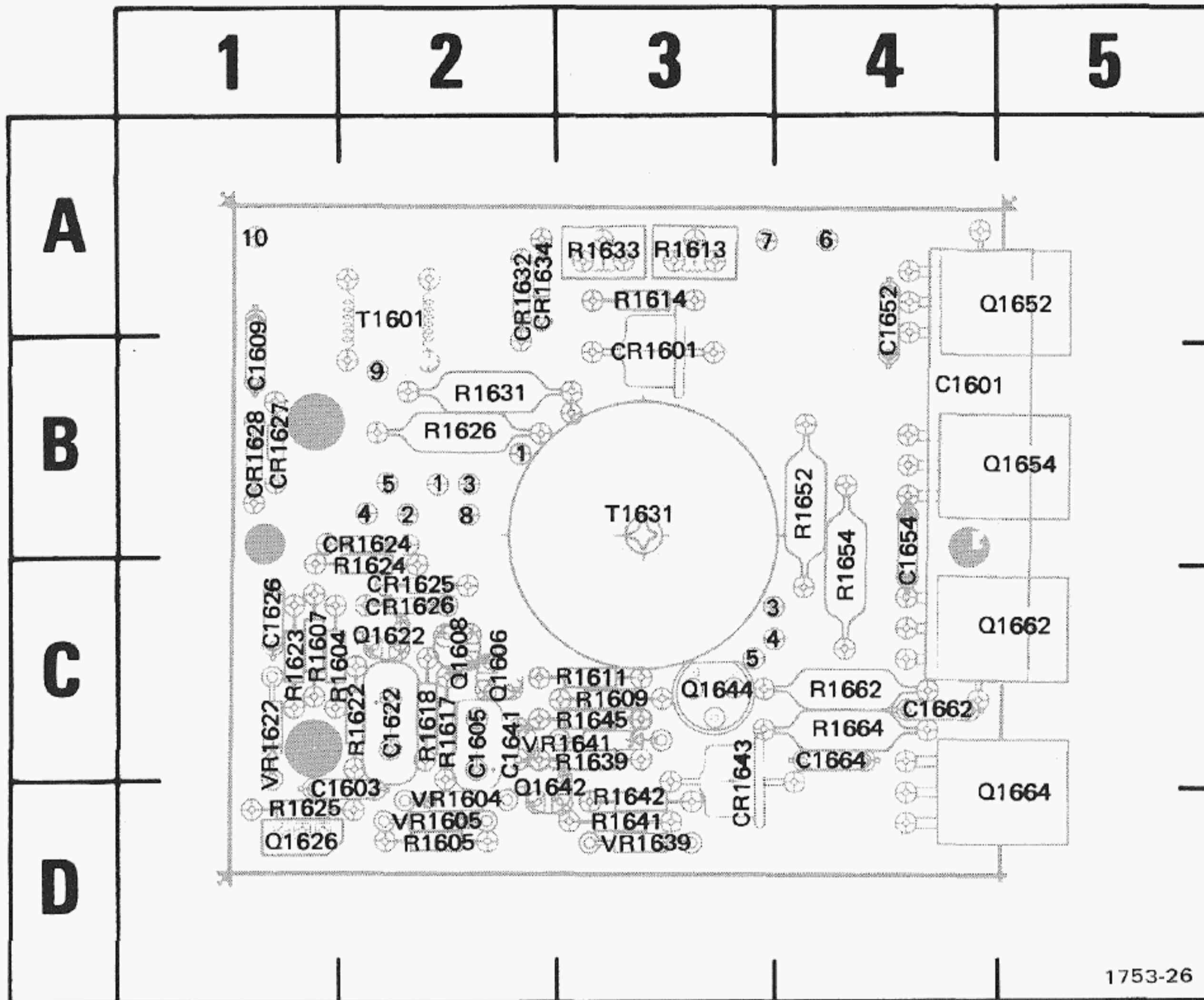

CKT NO	GRID LOC	CKT NO	GRID LOC	CKT NO	GRID LOC	CKT NO	GRID LOC
C1601	4B	CR1628	1B	R1605	2D	R1642	3D
C1603	2D	CR1632	2A	R1607	1C	R1645	3C
C1605	2C	CR1634	2A	R1609	3C	R1652	4B
C1609	1B	CR1643	3D	R1611	3C	R1654	4B
C1622	2C			R1613	3A	R1662	4C
C1626	1C	Q1606	2C	R1614	3A	R1664	4C
C1641	2C	Q1608	2C	R1617	2C		
C1652	4A	Q1622	2C	R1618	2C	T1601	2A
C1654	4B	Q1626	1D	R1622	2C	T1631	3B
C1662	4C	Q1642	2D	R1623	1C		
C1664	4C	Q1644	3C	R1624	2C	VR1604	2D
		Q1652	5A	R1625	1D	VR1605	2D
CR1601	3B	Q1654	5B	R1626	2B	VR1622	1C
CR1624	2B	Q1662	5C	R1631	2B	VR1639	3D
CR1625	2C	Q1664	5D	R1633	3A	VR1641	3C
CR1626	2C			R1639	3C		
CR1627	1B	R1604	1C	R1641	3D		

Fig. 7-8. Circuit board layout with component locator grid.

OPTION 7

REPLACEABLE ELECTRICAL PARTS

ABBREVIATIONS

ACTR	ACTUATOR	PLSTC	PLASTIC
ASSY	ASSEMBLY	QTZ	QUARTZ
CAP	CAPACITOR	RECP	RECEPTACLE
CER	CERAMIC	RES	RESISTOR
CKT	CIRCUIT	RF	RADIO FREQUENCY
COMP	COMPOSITION	SEL	SELECTED
CONN	CONNECTOR	SEMICOND	SEMICONDUCTOR
ELCTLT	ELECTROLYTIC	SENS	SENSITIVE
ELEC	ELECTRICAL	VAR	VARIABLE
INCAND	INCANDESCENT	WW	WIREWOUND
LED	LIGHT EMITTING DIODE	XFMR	TRANSFORMER
NONWIR	NON WIREWOUND	XTAL	CRYSTAL

ADDITIONAL PARTS ADDED TO STANDARD 465

Ckt No.	Tektronix Part No.	Serial/Model No. Eff	Dscont	Name & Description	Mfr Code	Mfr Part Number
C1601	290-0667-00			CAP.,FXD,ELCTLT:330UF,+75-10%,50V	90201	TTX331U050GLJ3
C1671	283-0000-00			CAP.,FXD,CER DI:0.001UF,+100-0%,500V	72982	831-516E102P
C1672	283-0263-00 ¹			CAP.,FXD,CER DI:0.0022UF,20%,3000V	56289	33C319
C1674	283-0263-00 ¹			CAP.,FXD,CER DI:0.0022UF,20%,3000V	56289	33C319
C1681	283-0000-00			CAP.,FXD,CER DI:0.001UF,+100-0%,500V	72982	831-516E102P
C1682	283-0000-00			CAP.,FXD,CER DI:0.001UF,+100-0%,500V	72982	831-516E102P
C1683	283-0003-00			CAP.,FXD,CER DI:0.01UF,+80-20%,150V	72982	855-547E103Z
C1684	283-0003-00			CAP.,FXD,CER DI:0.01UF,+80-20%,150V	72982	855-547E103Z
C1685	283-0003-00			CAP.,FXD,CER DI:0.01UF,+80-20%,150V	72982	855-547E103Z
F1601	159-0038-00			FUSE,CARTRIDGE:3AG,15A,32V,FAST-BLOW	71400	AGC15
P1601	131-1333-00			CONNECTOR,RCPT,:POWER	80009	131-1333-00
Q1652	151-0436-00			TRANSISTOR:SILICON,NPN	80009	151-0436-00
Q1654	151-0436-00			TRANSISTOR:SILICON,NPN	80009	151-0436-00
Q1662	151-0436-00			TRANSISTOR:SILICON,NPN	80009	151-0436-00
Q1664	151-0436-00			TRANSISTOR:SILICON,NPN	80009	151-0436-00
R1671	302-0102-00	B250000	B255984	RES.,FXD,COMP:1K OHM,10%,0.5W	01121	BB 1021
R1671	308-0077-00	B255985		RES.,FXD,WW:1K OHM,10%,3W	91637	RS2B-B10000J
S1601	260-0834-00			SWITCH,TOGGLE:DPDT,5A,125VAC,0.25-40 THD	09353	7201-SN
S1665	105-0479-00			ACTUATOR,SW:INVERTER	80009	105-0479-00
S1665A	260-0760-00			SWITCH,SENS:10A,250V,SPDT,SNAP ACTION	01963	E62-10A
S1665B	260-0760-00			SWITCH,SENS:10A,250V,SPDT,SNAP ACTION	01963	E62-10A
S1665C	260-0760-00			SWITCH,SENS:10A,250V,SPDT,SNAP ACTION	01963	E62-10A
S1665D	260-0760-00			SWITCH,SENS:10A,250V,SPDT,SNAP ACTION	01963	E62-10A
S1665E	260-0760-00			SWITCH,SENS:10A,250V,SPDT,SNAP ACTION	01963	E62-10A
S1665F	260-0760-00			SWITCH,SENS:10A,250V,SPDT,SNAP ACTION	01963	E62-10A

¹ Mounted on 465 rear panel.

Options 465 Service (SN B250000-up)

Ckt No.	Tektronix Part No.	Serial/Model No. Eff Dscont	Name & Description	Mfr Code	Mfr Part Number
	670-2744-00		CKT BOARD ASSY:DC INVERTER	80009	670-2744-00
C1603	283-0178-00		CAP.,FXD,CER DI:0.1UF,+80-20%,100V	72982	8131N145651104Z
C1605	290-0531-00		CAP.,FXD,ELCTLT:100UF,20%,10V	90201	TDC107M010CL
C1609	283-0178-00		CAP.,FXD,CER DI:0.1UF,+80-20%,100V	72982	8131N145651104Z
C1614	290-0573-00		CAP.,FXD,ELCTLT:2.7UF,20%,50V	56289	196D275X0050JA1
C1622	290-0533-00		CAP.,FXD,ELCTLT:330UF,20%,6V	56289	196D337X006MA3
C1626	290-0528-00		CAP.,FXD,ELCTLT:15UF,20%,50V	90201	TDC156M050WLC
C1652	283-0110-00		CAP.,FXD,CER DI:0.005UF,+80-20%,150V	56289	19C242B
C1654	283-0110-00		CAP.,FXD,CER DI:0.005UF,+80-20%,150V	56289	19C242B
C1662	283-0110-00		CAP.,FXD,CER DI:0.005UF,+80-20%,150V	56289	19C242B
C1664	283-0110-00		CAP.,FXD,CER DI:0.005UF,+80-20%,150V	56289	19C242B
CR1601	152-0198-00		SEMICONV DEVICE:SILICON,200V,3A	04713	1N4721
CR1624	152-0333-00		SEMICONV DEVICE:SILICON,55V,200MA	80009	152-0333-00
CR1625	152-0107-00		SEMICONV DEVICE:SILICON,375V,400MA	80009	152-0107-00
CR1626	152-0107-00		SEMICONV DEVICE:SILICON,375V,400MA	80009	152-0107-00
CR1627	152-0107-00		SEMICONV DEVICE:SILICON,375V,400MA	80009	152-0107-00
CR1628	152-0107-00		SEMICONV DEVICE:SILICON,375V,400MA	80009	152-0107-00
CR1632	152-0333-00		SEMICONV DEVICE:SILICON,55V,200MA	80009	152-0333-00
CR1634	152-0333-00		SEMICONV DEVICE:SILICON,55V,200MA	80009	152-0333-00
CR1643	152-0198-00		SEMICONV DEVICE:SILICON,200V,3A	04713	1N4721
Q1606	151-0301-00		TRANSISTOR:SILICON,PNP	04713	2N2907A
Q1608	151-0301-00		TRANSISTOR:SILICON,PNP	04713	2N2907A
Q1622	151-0302-00		TRANSISTOR:SILICON,NPN	04713	2N2222A
Q1626	151-0506-00		TRANSISTOR:SILICON,CONTROLLED RECTIFIER	03508	C106B2
Q1642	151-0302-00		TRANSISTOR:SILICON,NPN	04713	2N2222A
Q1644	151-0335-00		TRANSISTOR:SILICON,PNP	80009	151-0335-00
R1604	315-0202-00		RES.,FXD,COMP:2K OHM,5%,0.25W	01121	CB2025
R1605	315-0752-00		RES.,FXD,COMP:7.5K OHM,5%,0.25W	01121	CB7525
R1607	315-0272-00		RES.,FXD,COMP:2.7K OHM,5%,0.25W	01121	CB2725
R1609	315-0511-00		RES.,FXD,COMP:510 OHM,5%,0.25W	01121	CB5115
R1611	315-0511-00		RES.,FXD,COMP:510 OHM,5%,0.25W	01121	CB5115
R1613	311-1248-00		RES.,VAR,NONWIR:500 OHM,10%,0.50W	73138	72X-23-0-501K
R1614	315-0202-00		RES.,FXD,COMP:2K OHM,5%,0.25W	01121	CB2025
R1617	315-0102-00		RES.,FXD,COMP:1K OHM,5%,0.25W	01121	CB1025
R1618	315-0101-00		RES.,FXD,COMP:100 OHM,5%,0.25W	01121	CB1015
R1622	315-0102-00		RES.,FXD,COMP:1K OHM,5%,0.25W	01121	CB1025
R1623	315-0103-00		RES.,FXD,COMP:10K OHM,5%,0.25W	01121	CB1035
R1624	315-0302-00		RES.,FXD,COMP:3K OHM,5%,0.25W	01121	CB3025
R1625	316-0101-00		RES.,FXD,COMP:100 OHM,10%,0.25W	01121	CB1011
R1626	308-0451-00		RES.,FXD,WW:91 OHM,5%,3W	91637	RS2B-B91R00J
R1631	308-0451-00		RES.,FXD,WW:91 OHM,5%,3W	91637	RS2B-B91R00J
R1633	311-1501-00		RES.,VAR,NONWIR:20 OHM,10%,0.50W	73138	72X-37-0-200K
R1639	315-0153-00		RES.,FXD,COMP:15K OHM,5%,0.25W	01121	CB1535
R1640	315-0102-00		RES.,FXD,COMP:1K OHM,5%,0.25W	01121	CB1025
R1641	315-0153-00		RES.,FXD,COMP:15K OHM,5%,0.25W	01121	CB1535
R1642	315-0470-00		RES.,FXD,COMP:47 OHM,5%,0.25W	01121	CB4705
R1645	307-0113-00		RES.,FXD,COMP:5.1 OHM,5%,0.25W	01121	CB51G5
R1652	308-0459-00		RES.,FXD,WW:1.1 OHM,5%,3W	91637	RS2B-D1R100J
R1654	308-0459-00		RES.,FXD,WW:1.1 OHM,5%,3W	91637	RS2B-D1R100J
R1662	308-0459-00		RES.,FXD,WW:1.1 OHM,5%,3W	91637	RS2B-D1R100J
R1664	308-0459-00		RES.,FXD,WW:1.1 OHM,5%,3W	91637	RS2B-D1R100J
T1601	120-0637-00		XFMR,TOROID:5 TURNS BIFILAR	80009	120-0637-00
T1631	120-0852-00		XFMR,TOROID:2 WINDINGS	80009	120-0852-00
VR1604	152-0306-00		SEMICONV DEVICE:ZENER,0.4W,9.1V,5%	81483	1N960B
VR1605	152-0306-00		SEMICONV DEVICE:ZENER,0.4W,9.1V,5%	81483	1N960B
VR1622	152-0241-00		SEMICONV DEVICE:ZENER,0.4W,33V,5%	04713	1N973B
VR1639	152-0279-00		SEMICONV DEVICE:ZENER,0.4W,5.1V,5%	07910	1N751A
VR1641	152-0279-00		SEMICONV DEVICE:ZENER,0.4W,5.1V,5%	07910	1N751A

OPTION 7

REPLACEABLE MECHANICAL PARTS

ABBREVIATIONS

BHB binding head brass
 BHS binding head steel
 CRT cathode-ray tube
 csk countersunk
 DE double end
 FHB flat head brass
 FHS flat head steel
 Fil HB fillister head brass
 Fil HS fillister head steel

h height or high
 hex. hexagonal
 HHB hex head brass
 HHS hex head steel
 HSB hex socket brass
 HSS hex socket steel
 ID inside diameter
 lg length or long
 OD outside diameter

OHB oval head brass
 OHS oval head steel
 PHB pan head brass
 PHS pan head steel
 RHS round head steel
 SE single end
 THB truss head brass
 THS truss head steel
 w wide or width

Fig. & Index No.	Tektronix Part No.	Serial/Model No. Eff Dscont	Qty	Name & Description					Mfr Code	Mfr Part Number
				1	2	3	4	5		
9-1	441-1171-00		1	CHAS,ELEK EQUIP:DC INVERTER (ATTACHING PARTS)					80009	441-1171-00
	211-0008-00		2	SCREW,MACHINE:4-40 X 0.25 INCH,PNH STL					83385	OBD
	210-0938-00		2	WASHER,FLAT:0.109 ID X 0.25 INCH OD,STL					75497	AN960-3
				- - - * - - -						
-2	-----		1	CIRCUIT BOARD ASSY:INVERTER						
-3	136-0252-04		15	. CONTACT,ELEC:0.188 INCH LONG					22526	75060
-4	-----		1	. XFMR,TOROID:(SEE TL601 EPL) (ATTACHING PARTS)						
-5	343-0443-00		1	. RETAINER,XFMR:					80009	343-0443-00
-6	212-0011-00		1	. SCREW,MACHINE:8-32 X 0.750 INCH,FLH STL					83385	OBD
-7	210-0409-00		1	. NUT,PLAIN,HEX.:8-32 X 0.312 INCH,BRS					73743	3046-402
				- - - * - - -						
				(ATTACHING PARTS)						
-8	211-0116-00		2	SCR,ASSEM WSHR:4-40 X 0.312 INCH,PNH BRS					83385	OBD
				- - - * - - -						
-9	-----		4	TRANSISTOR:(SEE Q1652,Q1654,Q1662,Q1664 EPL) (ATTACHING PARTS)						
-10	210-0586-00		3	NUT,PLAIN,EXT W:4-40 X 0.25 INCH,STL					78189	OBD
-11	343-0451-00		1	RETAINER,XSTR:					80009	343-0451-00
-12	342-0195-00		1	INSULATOR,PLATE:0.70 X 3 INCH LONG					08530	OBD
				- - - * - - -						
-13	348-0141-00		1	GROMMET,PLASTIC:U-SHP,0.625 X0.658 INCH					80009	348-0141-00
-14	348-0055-00		1	GROMMET,PLASTIC:0.25 INCH DIA					80009	348-0055-00
-15	352-0031-00		1	FUSEHOLDER:3AG FUSE (ATTACHING PARTS)					75915	357001
-16	211-0507-00		1	SCREW,MACHINE:6-32 X 0.312 INCH,PNH STL					83385	OBD
-17	210-0006-00		1	WASHER,LOCK:INTL,0.146 ID X 0.283"OD,STL					78189	1206-00-00-0541C
-18	210-0407-00		1	NUT,PLAIN,HEX.:6-32 X 0.25 INCH,BRS					73743	3038-0228-402
				- - - * - - -						
	342-0228-00		1	INSULATOR,FILM:0.70 X 1.150 INCH LONG					80009	342-0228-00
-19	407-1341-00		1	BRACKET,SWITCH:INVERTER (ATTACHING PARTS)					80009	407-1341-00
-20	211-0101-00		2	SCREW,MACHINE:4-40 X 0.25" 100 DEG,FLH STL					83385	OBD
				- - - * - - -						
-21	105-0479-00		1	ACTUATOR,SWITCH:INVERTER					80009	105-0479-00
-22	260-0760-00		6	SWITCH,SENS:SPDT,10A,250V (ATTACHING PARTS)					01963	E62-10A
-23	211-0212-00		2	SCREW,MACHINE:2-56 X 1.75 INCH,PNH STL					83385	OBD
-24	210-0405-00		1	NUT,PLAIN,HEX.:2-56 X 0.188 INCH,BRS					73743	2X12157-402
				- - - * - - -						
-25	386-2649-00		1	PLATE,ACT GUIDE:INVERTER					80009	386-2649-00
	214-1925-00		1	SPRING,SW ACT:POWER SOURCE					80009	214-1925-00
-26	260-0834-00		1	SWITCH,TOGGLE:DPDT,5A,125VAC,0.25-40 THD (ATTACHING PARTS)					09353	7201-SN
-27	210-0562-00		1	NUT,PLAIN,HEX.:0.25-40 X 0.312 INCH,BRS					73743	2X20224-402
-28	210-0046-00		1	WASHER,LOCK:INTL,0.26 ID X 0.40" OD,STL					78189	1214-05-00-0541C
				- - - * - - -						
	179-1963-00		1	WIRING HARNESS:					80009	179-1963-00
	348-0005-00		1	GROMMET,RUBBER:0.50 INCH DIA					70485	230
	200-1414-03		1	COVER,OSCP:REAR					80009	200-1414-03
	131-1333-00		1	CONNECTOR,RCPT,:POWER (ATTACHING PARTS)					80009	131-1333-00
	211-0101-00		2	SCREW,MACHINE:4-40 X 0.25" 100 DEG,FLH STL					83385	OBD
	348-0365-00		4	FOOT,CABINET:PLASTIC,W/LATCH GROOVE					80009	348-0365-00
				- - - * - - -						
		ACCESSORIES	1	CABLE,ASSY,PWR:3 WIRE,36 INCHES LONG					16428	KH7667

OPTION 7 EXPLODED

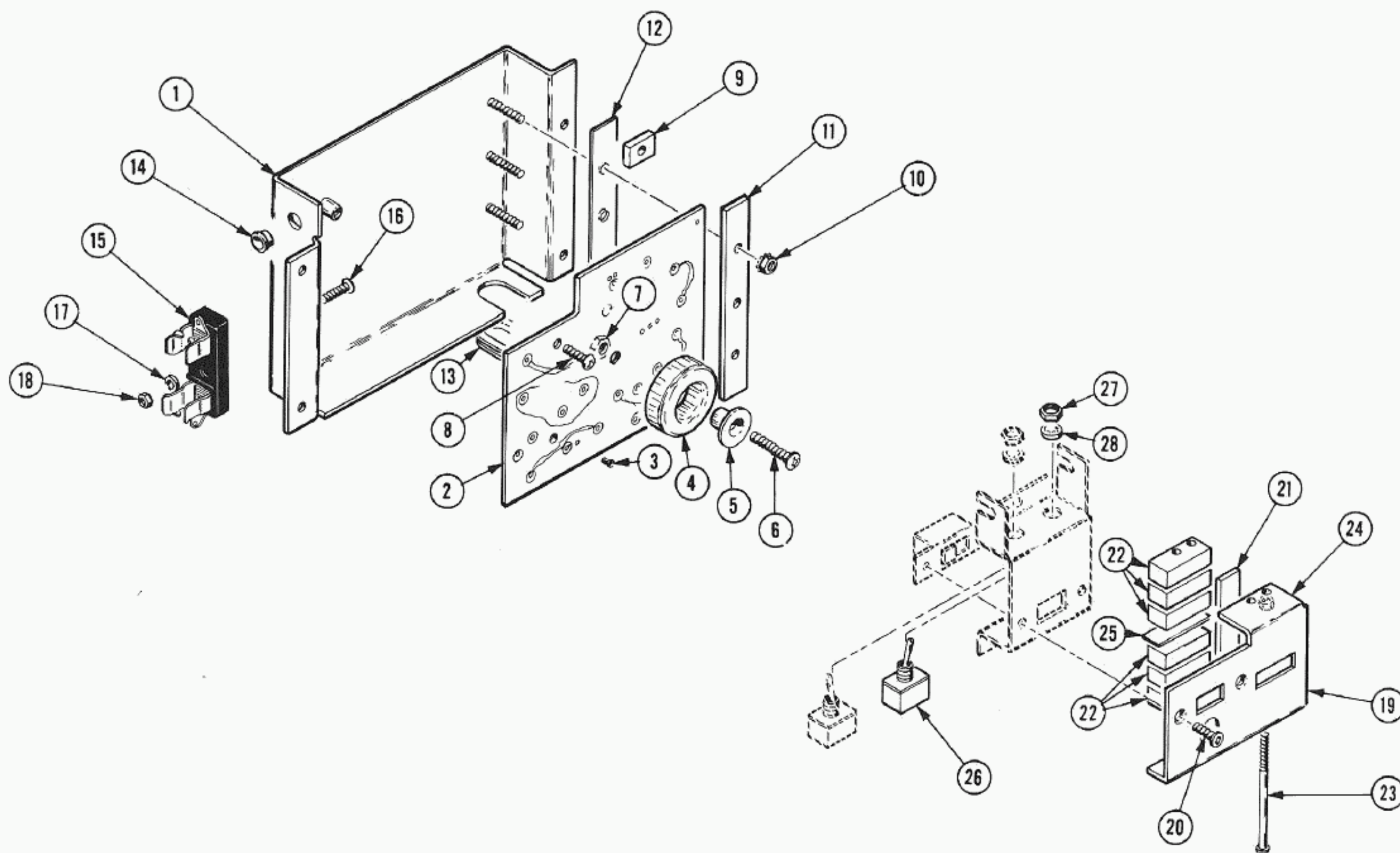

Fig. Option 7-9

OPTION 78

This option adds a Type P11 phosphor CRT to the instrument.

Parts List Changes

DELETE:

V1440	154-0676-10	CRT, P31 Phosphor
-------	-------------	-------------------

ADD:

V1440	154-0676-14	CRT, P11 Phosphor
-------	-------------	-------------------

If this option is being added to an instrument which is already equipped with a different phosphor, or if the cathode-ray tube requires replacement, use the following procedure:

1). Follow the crt removal and installation procedure in the maintenance section of this manual.

2). After completing crt installation, check Table 6-1 (Adjustment Interactions) for calibration adjustments which may require re-adjustment.

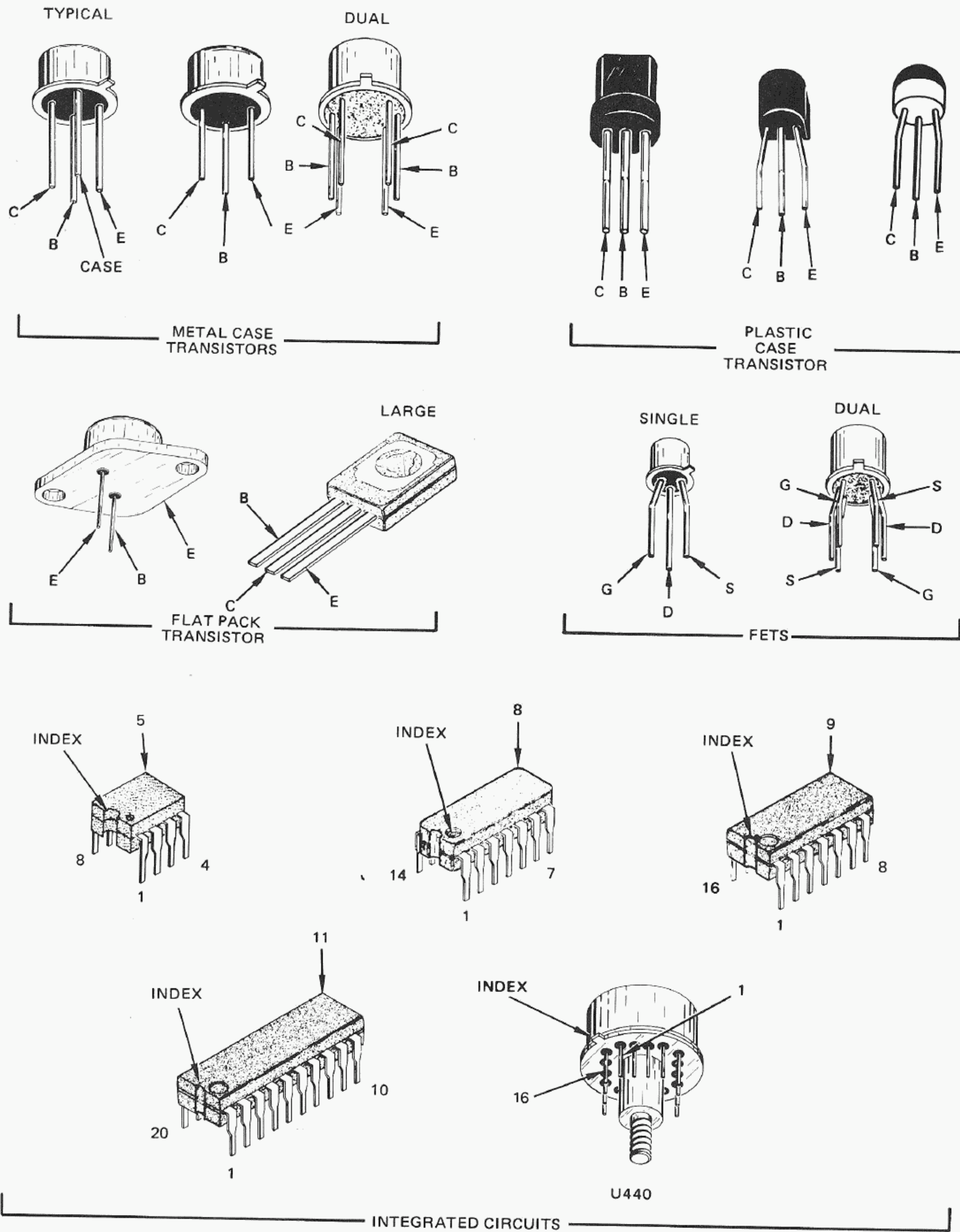

Fig. 8-1. Semiconductor lead configurations.

S
E

S
L
f
T

A
A
B
B
C
C
D
D
E
E
F
F
I

Tt

+

DIAGRAMS AND CIRCUIT BOARD ILLUSTRATIONS

Symbols and Reference Designators

Electrical components shown on the diagrams are in the following units unless noted otherwise:

- Capacitors = Values one or greater are in picofarads (pF).
Values less than one are in microfarads (μ F).
- Resistors = Ohms (Ω).

Symbols used on the diagrams are based on ANSI Standard Y32.2-1970.

Logic symbology is based on ANSI Y32.14-1973 in terms of positive logic. Logic symbols depict the logic function performed and may differ from the manufacturer's data.

The following prefix letters are used as reference designators to identify components or assemblies on the diagrams.

Assembly, separable or repairable (circuit board, etc.)	H	Heat dissipating device (heat sink, heat radiator, etc.)	RT	Thermistor
Attenuator, fixed or variable	HR	Heater	S	Switch
Motor	HY	Hybrid circuit	T	Transformer
Battery	J	Connector, stationary portion	TC	Thermocouple
Capacitor, fixed or variable	K	Relay	TP	Test point
Circuit breaker	L	Inductor, fixed or variable	U	Assembly, inseparable or non-repairable (integrated circuit, etc.)
Diode, signal or rectifier	LR	Inductor/resistor combination	V	Electron tube
Delay line	M	Meter	VR	Voltage regulator (zener diode, etc.)
Indicating device (lamp)	P	Connector, movable portion	Y	Crystal
Spark Gap	Q	Transistor or silicon-controlled rectifier	Z	Phase shifter
Fuse	R	Resistor, fixed or variable		
Filter				

The following special symbols are used on the diagrams:

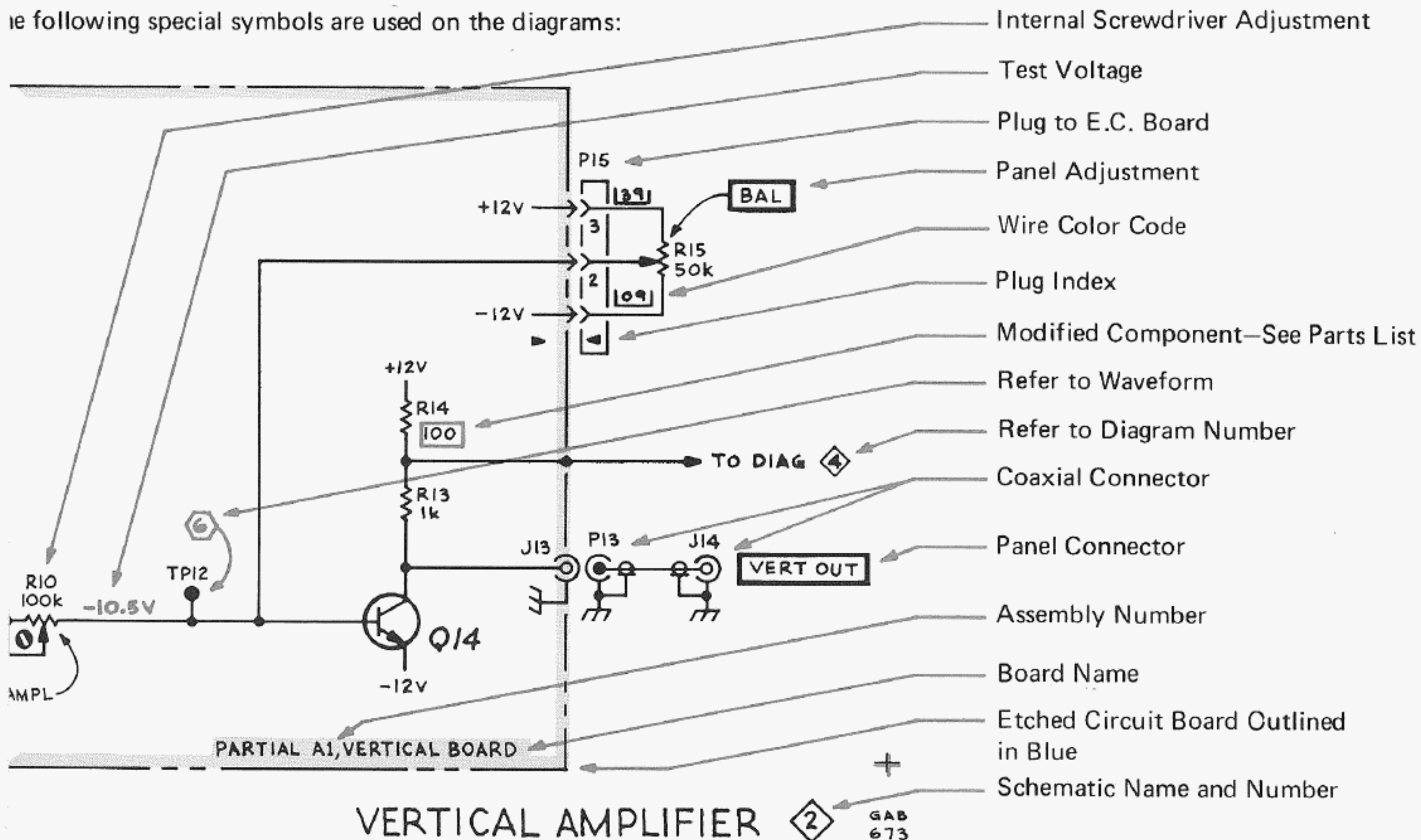

WAVEFORMS

The waveforms adjacent to the circuit diagrams were obtained using the recommended test equipment and setup given below unless otherwise noted.

RECOMMENDED TEST EQUIPMENT

Item	Specifications	Recommended Type
Test Oscilloscope	Frequency Response: Dc-100 MHz Deflection Factor: 5 mV/div to 5 V/Div Input Impedance: 1 mΩ, 20 pF Sweep Rate: 0.05 s to 0.5 μs/div	Tektronix 465 or equivalent
Probe (2 required)	Fast-rise 10X probe compatible with the vertical amplifier of the test oscilloscope.	Tektronix P6065A
Probe	1X probe compatible with the 465 vertical amplifier	Tektronix P6011 (for trigger-view waveforms only)

465 SETUP

Apply the 465 calibrator signal to the Channel 1 input via a 10X probe (supplied with the 465). Connect the 465 A +Gate (from the rear panel) to the test oscilloscope external trigger input via a 42-inch unterminated BNC cable.

Sweep Controls

A TIME/DIV	1 ms
B TIME/DIV	0.2 ms
VAR	Calibrated detent
DELAY TIME POSITION	5.00
HORIZ DISPLAY	MIX
X10 MAG (IN)	OFF (button out)
POSITION	Midrange
FINE	Midrange

465 CONTROL SETTINGS

CRT Controls

INTENSITY	As desired
FOCUS	As desired
SCALE ILLUM	As desired

Vertical Controls (both Channels if applicable)

VOLTS/DIV	50 mV (6 divisions of vertical display)
VAR	Calibrated detent
POSITION	Midrange
AC-GND-DC	DC
VERT MODE	CH 1
INVERT	Off (button out)
20 MHz BW LIMIT	Off (no yellow showing)

Triggering Controls (both A and B unless otherwise noted)

COUPLING	AC
A LEVEL	As needed for a stable display
B LEVEL	As needed for a stable B portion of the mixed sweep.
SLOPE	+
SOURCE	NORM
TRIG MODE	AUTO
A TRIG HOLDOFF	NORM

TEST OSCILLOSCOPE SETUP

Connect the 465 A +Gate (from the rear panel) to the Test Oscilloscope external trigger input via a 42 inch unterminated BNC cable.

Connect a 10X probe to the channel one input. Apply the probe to the test point or component lead indicated on the back of the pullout page preceding the circuit diagram to which it applies.

Test Oscilloscope Control Settings

All controls as needed for the best display except as noted below:

Vertical Input Coupling	AC
Vertical Mode	Channel 1
Volts/Division	As noted on each waveform

Trigger Source	External
Trigger Coupling	AC
Trigger Mode	Auto

Time/Division	As noted on each waveform
---------------	---------------------------

Horizontal Position	To position the beginning of the display 1 division from the left graticule edge. This will allow time comparison of the waveforms. The beginning of the Test Oscilloscope display will be coincident with the beginning of the 465 A sweep.
---------------------	--

DC VOLTAGES

Typical voltage measurements were obtained under the following conditions unless otherwise noted on the individual diagrams. Voltage measurements were taken with no signal applied to the vertical or trigger inputs. All voltages measured with reference to chassis ground. Voltages rounded to the nearest tenth of a volt.

RECOMMENDED TEST EQUIPMENT

Item	Specifications	Example
Digital Multimeter (for voltages up to 1 kV)	Range: 0 to 1 kV Input Impedance: 10 MΩ	Tektronix DM 501 Digital Multimeter
DC Voltmeter (for voltages above 1 kV).	Range: 0 to 3 kV Input Impedance: 20 KΩ/V	Triplett Model 630NA

465 CONTROL SETTINGS

CRT Controls

INTENSITY Normal display intensity
 FOCUS Best focused trace
 SCALE ILLUM Fully clockwise

Vertical Controls (both channels unless otherwise noted)

VERT MODE ALT
 POSITION
 CH 1 Two divisions above center
 CH 2 Two divisions below center
 VOLTS/DIV 5 mV
 AC-GND-DC GND
 INVERT Off (button out)
 20 MHz BW LIMIT Off (no yellow showing)

Trigger Controls (A and B unless otherwise noted)

COUPLING AC
 A SOURCE NORM
 B SOURCE STARTS AFTER DELAY
 LEVEL Midrange
 SLOPE +
 A TRIG HOLDOFF NORM
 TRIG MODE AUTO

A and B Sweep Controls

X10 MAG Off (button out)
 POSITION and FINE Midrange
 HORIZ MODE A INTEN
 DELAY TIME POSITION 5.00
 A TIME/DIV 1 ms
 B TIME/DIV .1 ms

36
R1
38
19
23
15
Q2
1
C

CH 1
OR X

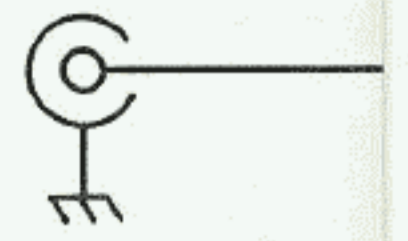

CH 1 VERTICAL PREAMP

CH 1 VERT
SIG OUT

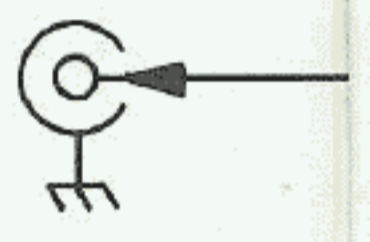

CH 2
OR Y

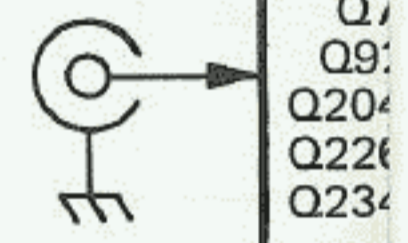

CH
Q7
Q9
Q20
Q22
Q23

CH 2 VERTICAL
PREAMP

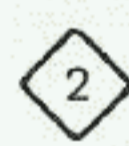

SIGN
A
Q
Q

A EXTERNAL
TRIGGER

INPUT



B EXTERNAL
TRIGGER

INPUT



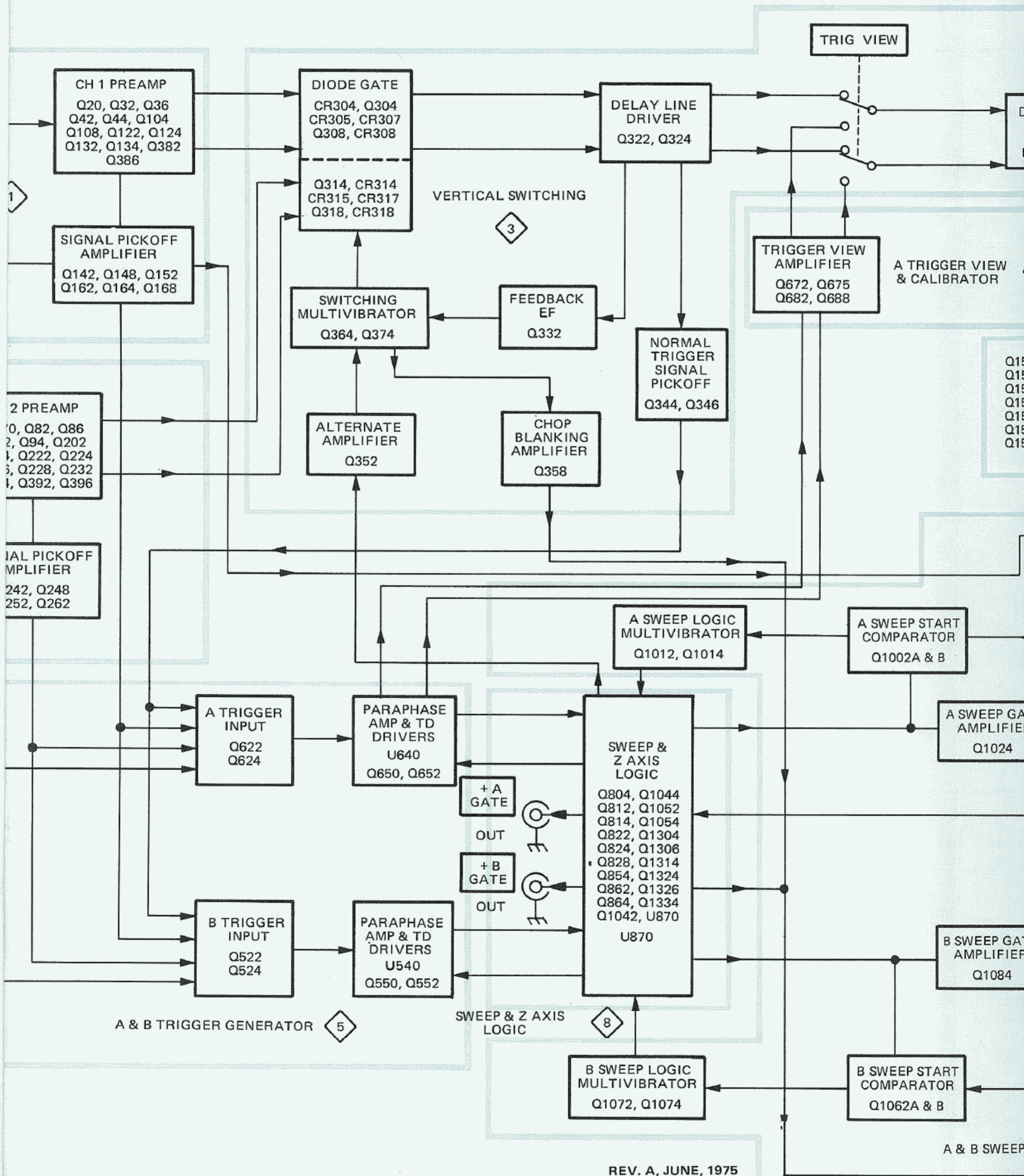

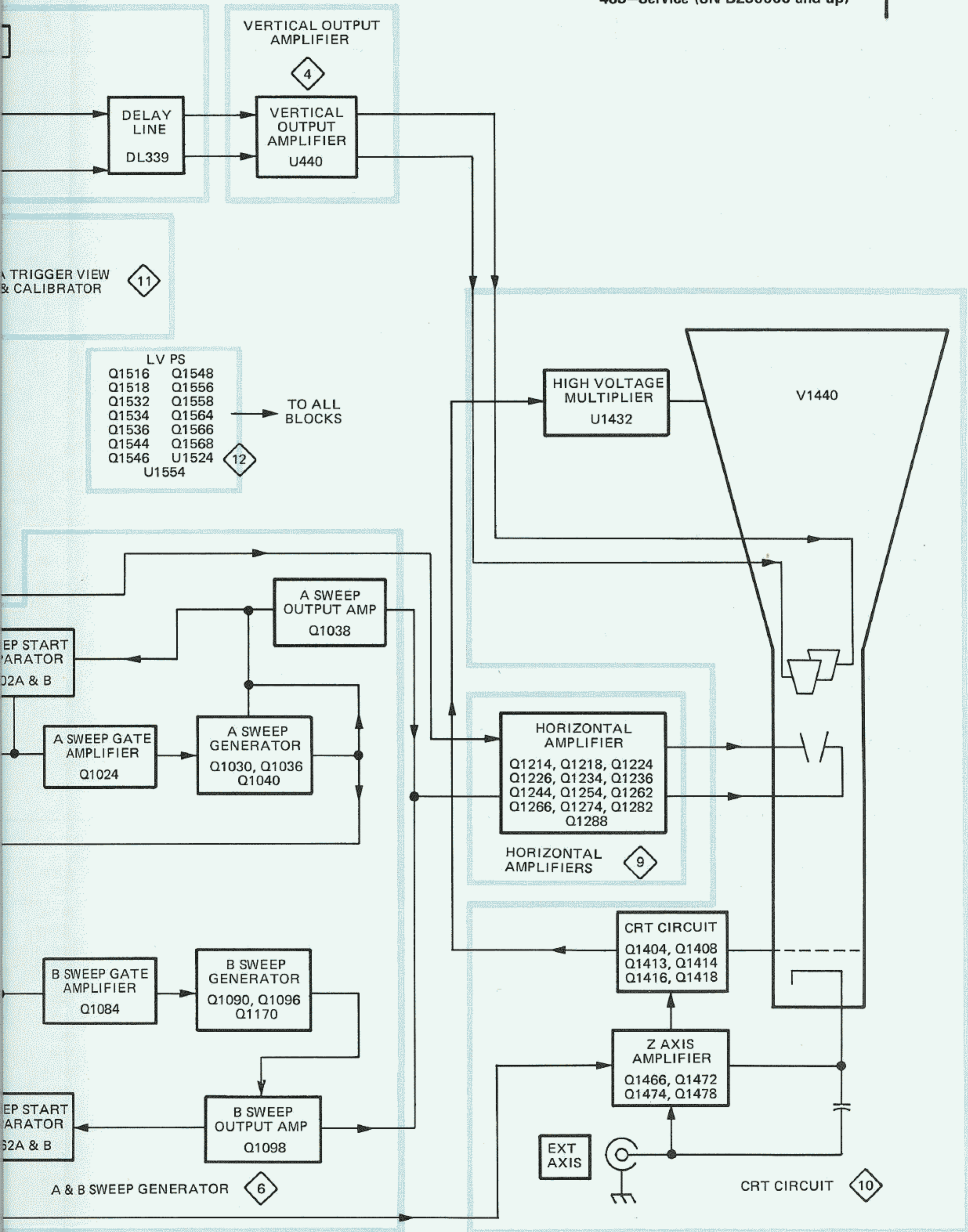

BLOCK DIAGRAM

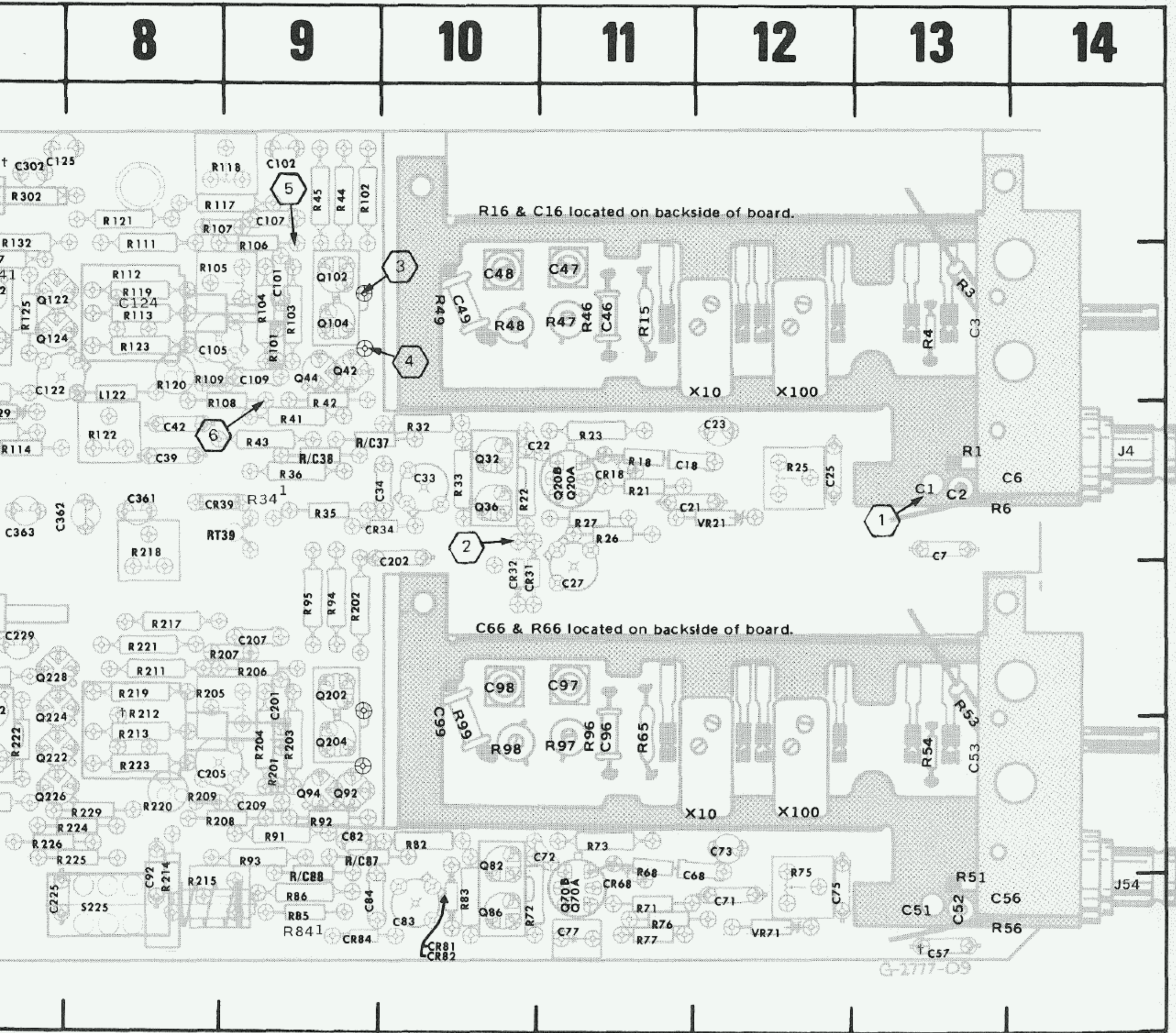

Resistors and A3—Vertical Preamp circuit boards.

GRID LOC	CKT NO	GRID LOC	CKT NO	GRID LOC	CKT NO	GRID LOC	CKT NO	GRID LOC
4A	R35	9C	R106	9B	R130	7B	R155	5B
2A	R36	9C	R107	8A	R132	7B	R161	3B
5B	R37	9C	R108	8C	R133	7B	R162	3A
6C	R38	9C	R109	8B	R134	7C	R164	3A
	R41	9C	R111	8B	R135	6B	R165	4A
13C	R42	9C	R112	8B	R136	6B	R168	3A
13B	R43	9C	R113	8B	R137	6B	R169	3B
13B	R44	9A	R114	7C	R138	6B		
13C	R45	9A	R115	7C	R141	6B	RT39	9C
11B	R46	11B	R116	7C	R142	5A	RT131	7B
11C	R47	11B	R117	8A	R143	5A		
11C	R48	10B	R119	8E	R144	6A	VR21	12C
10C	R49	10B	R120	8B	R145	5A	VR129	7C
11C	R85	9F	R121	8A	R146	5B		
12C	R101	9B	R122	8C	R147	6B		
11C	R102	9A	R123	8B	R149	6C		
11C	R103	9B	R125	7B	R151	5B		
10C	R104	9E	R127	7B	R152	4B		
10C	R105	8B	R128	7B	R154	4B		
9C								

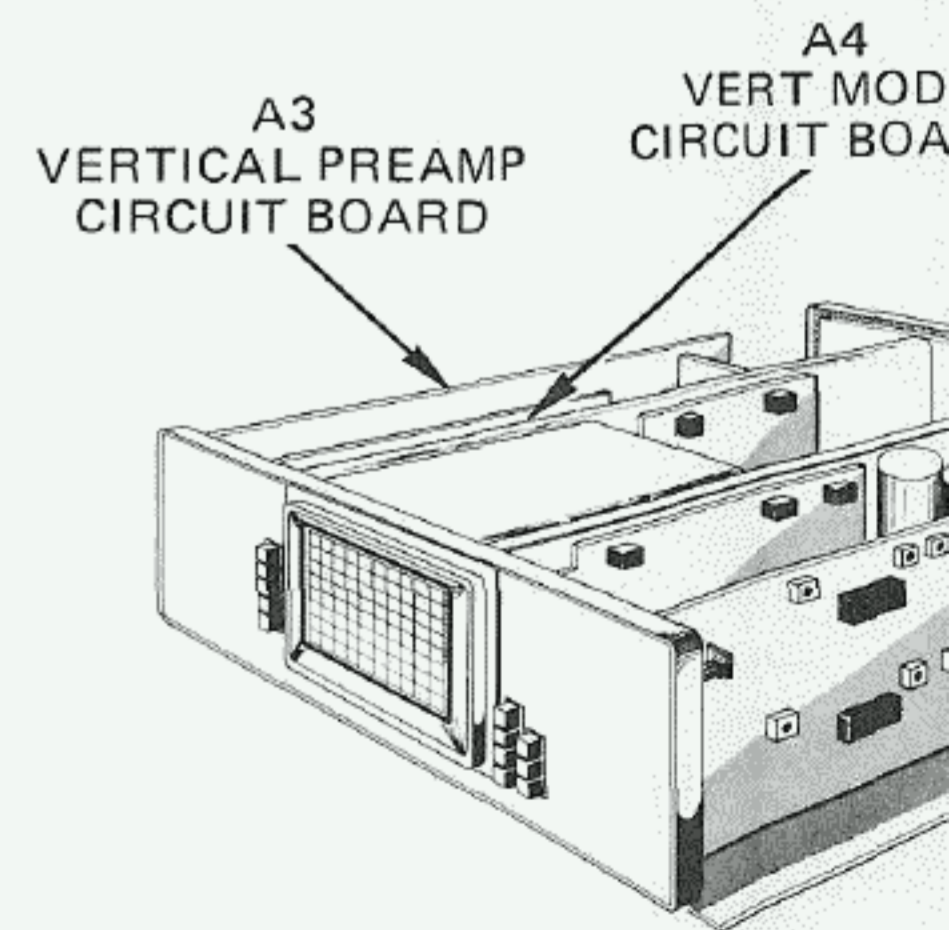

@

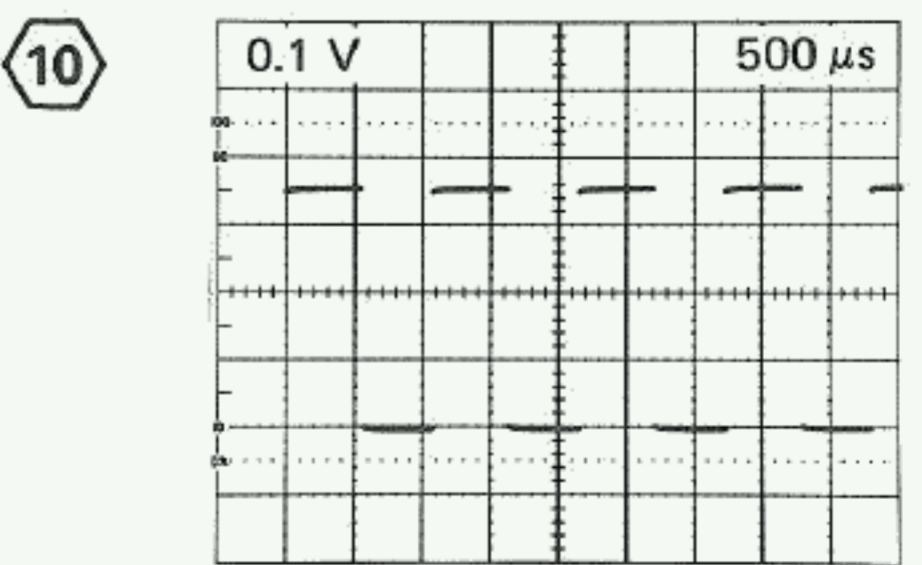
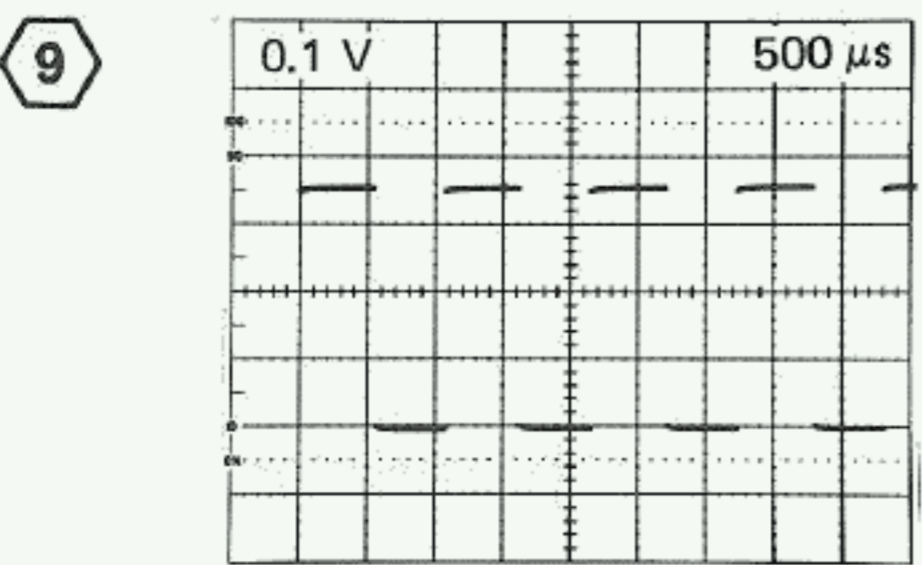
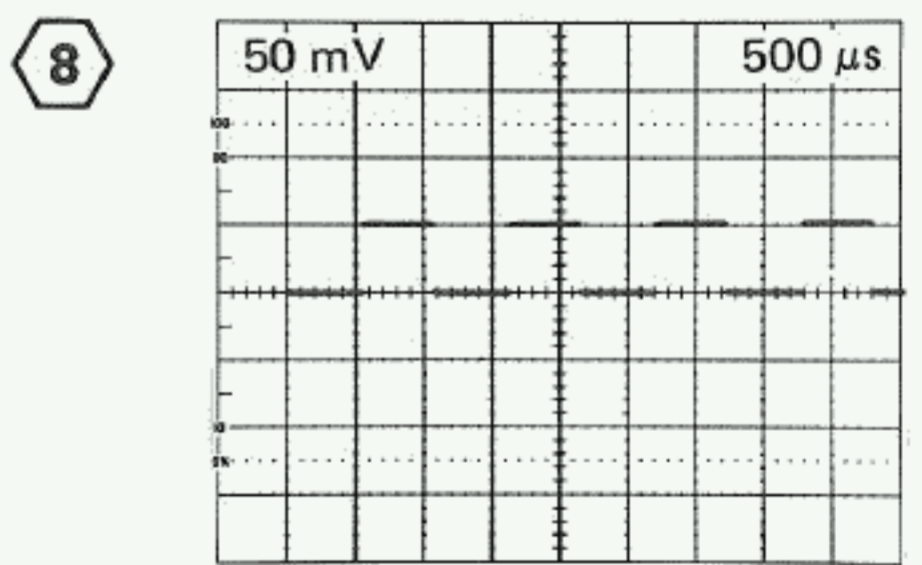
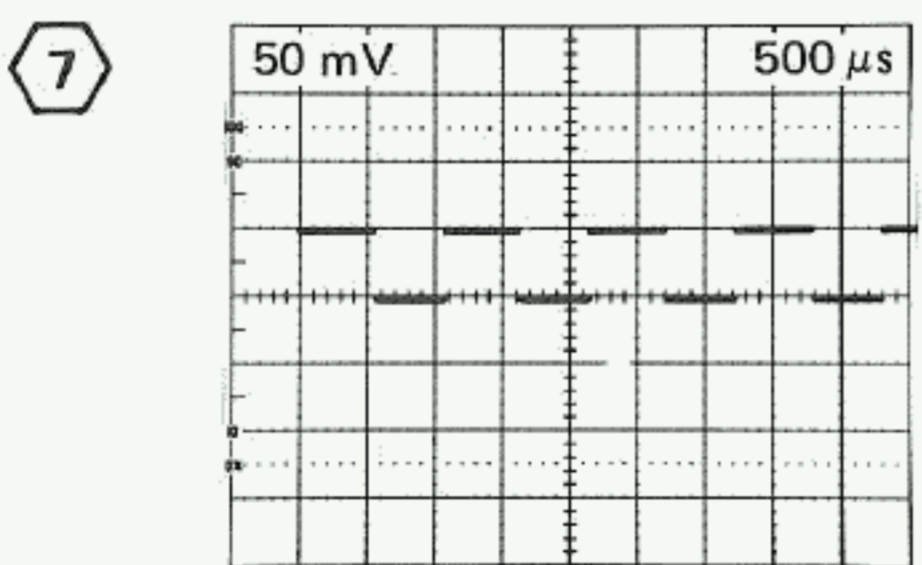
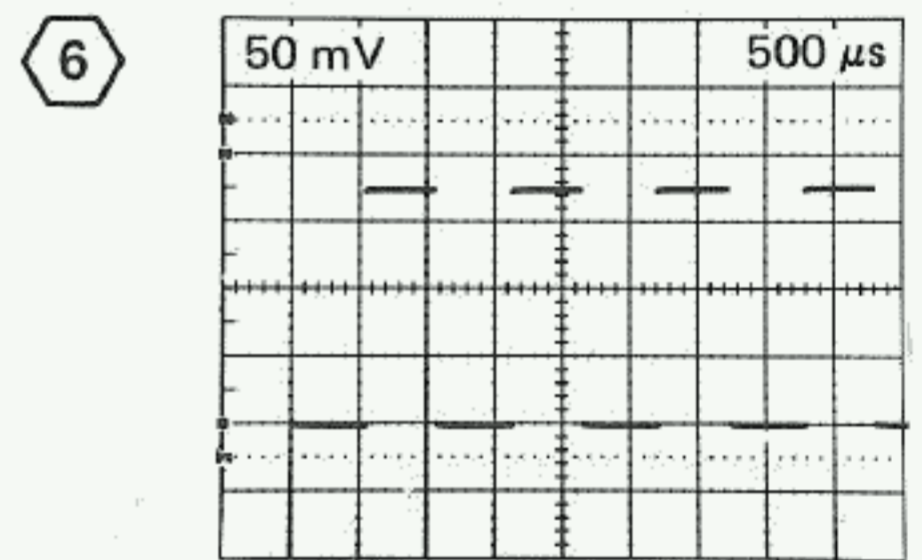
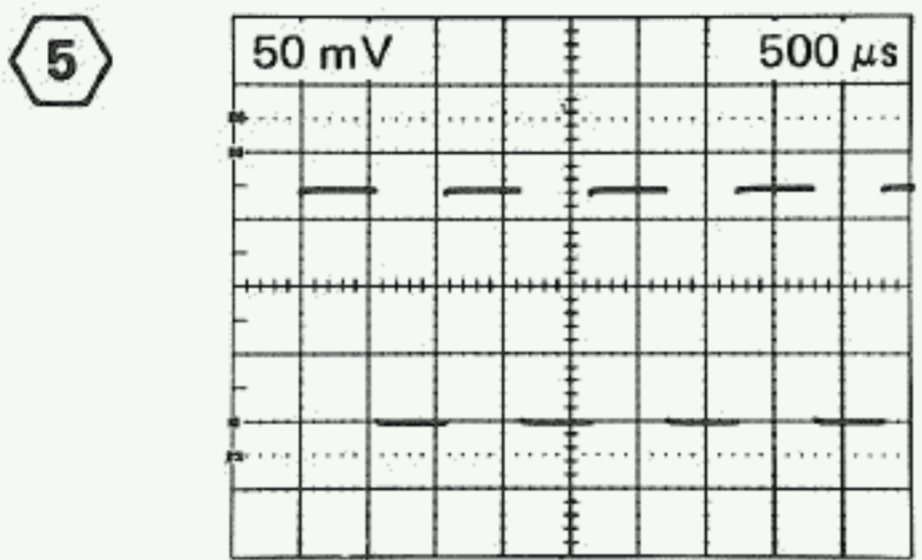
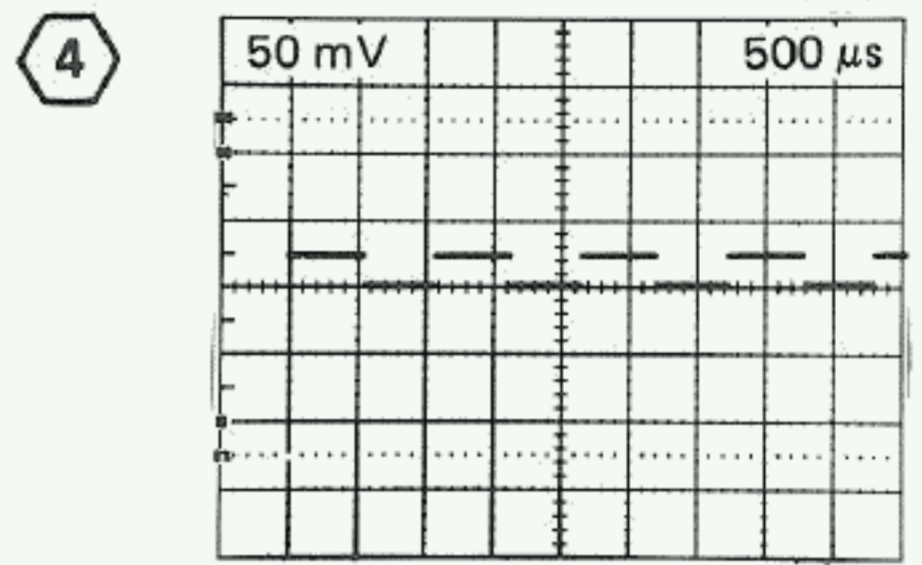
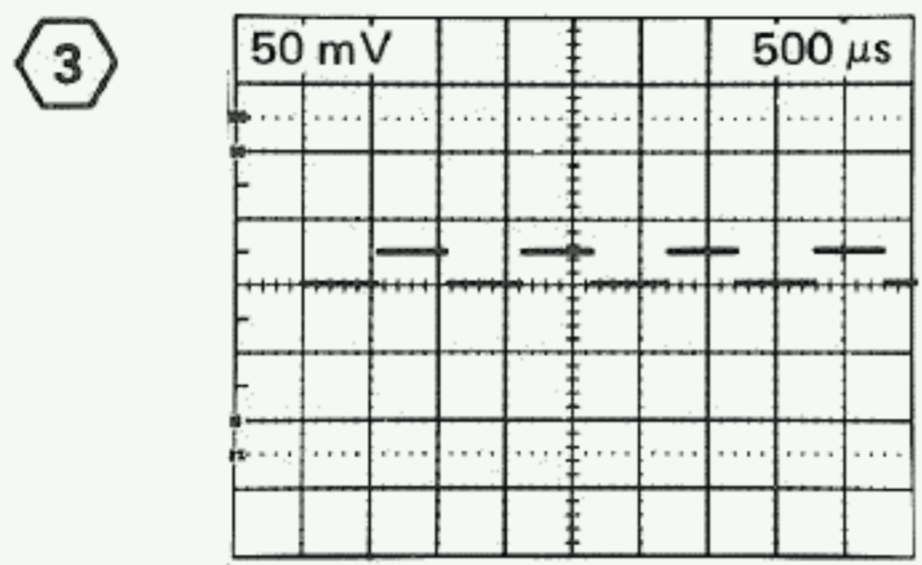
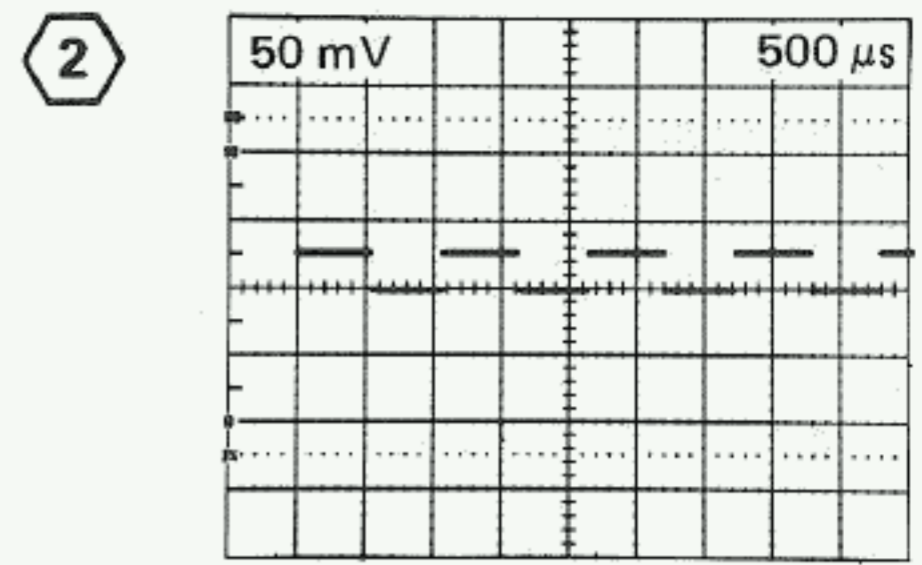
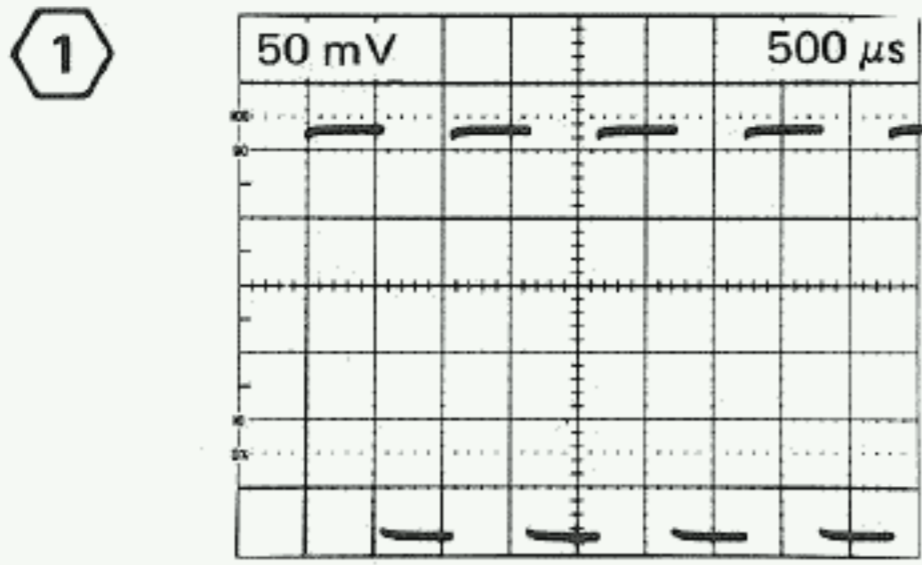

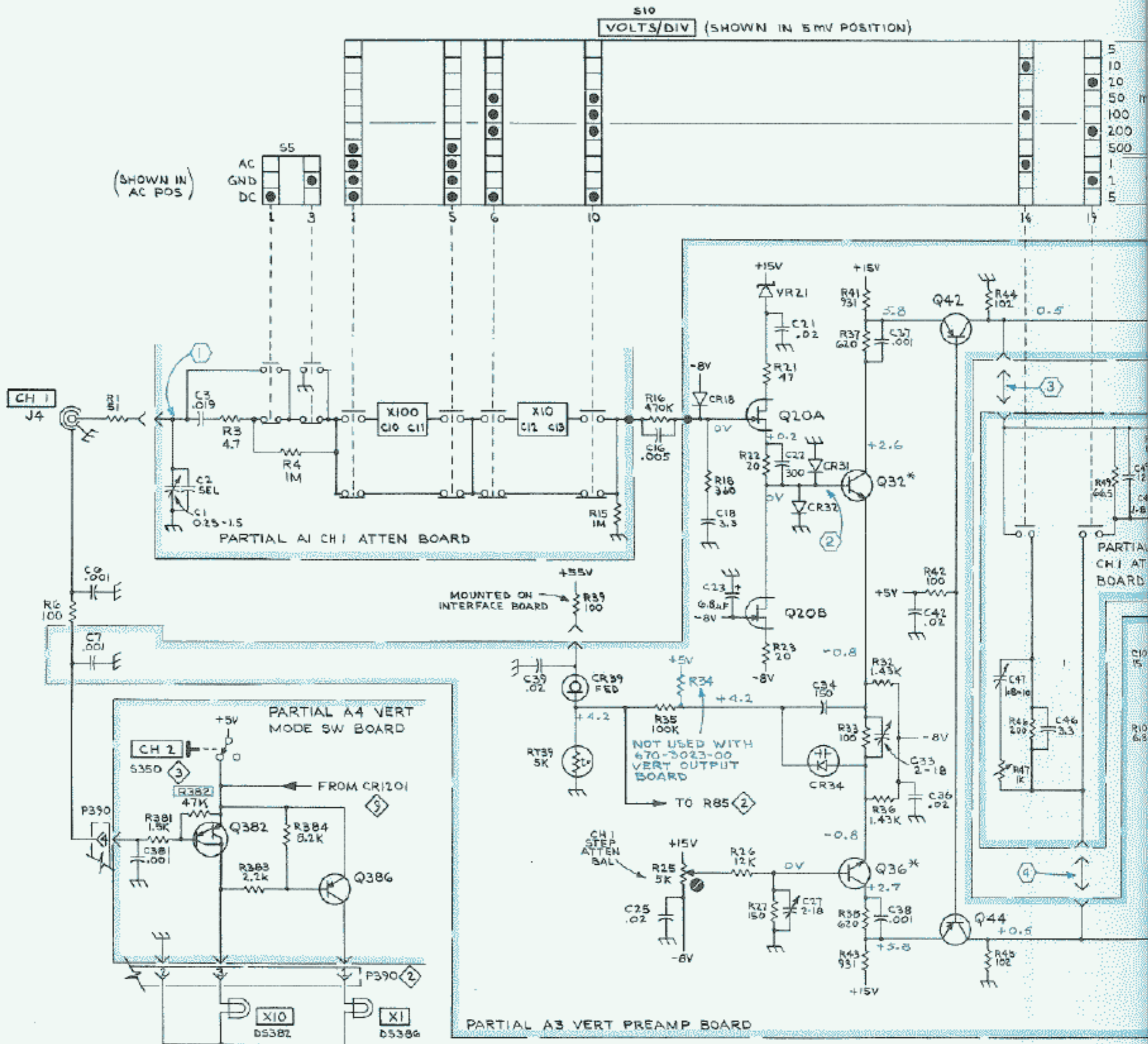

NOTE:
*, ϕ , \neq THERMAL COUPLED

SEE PARTS LIST FOR EARLIER
VALUES AND SERIAL NUMBER
RANGES OF PARTS MARKED
WITH BLUE OUTLINE.

SEE PARTS LIST FOR
SEMICONDUCTOR TYPES.

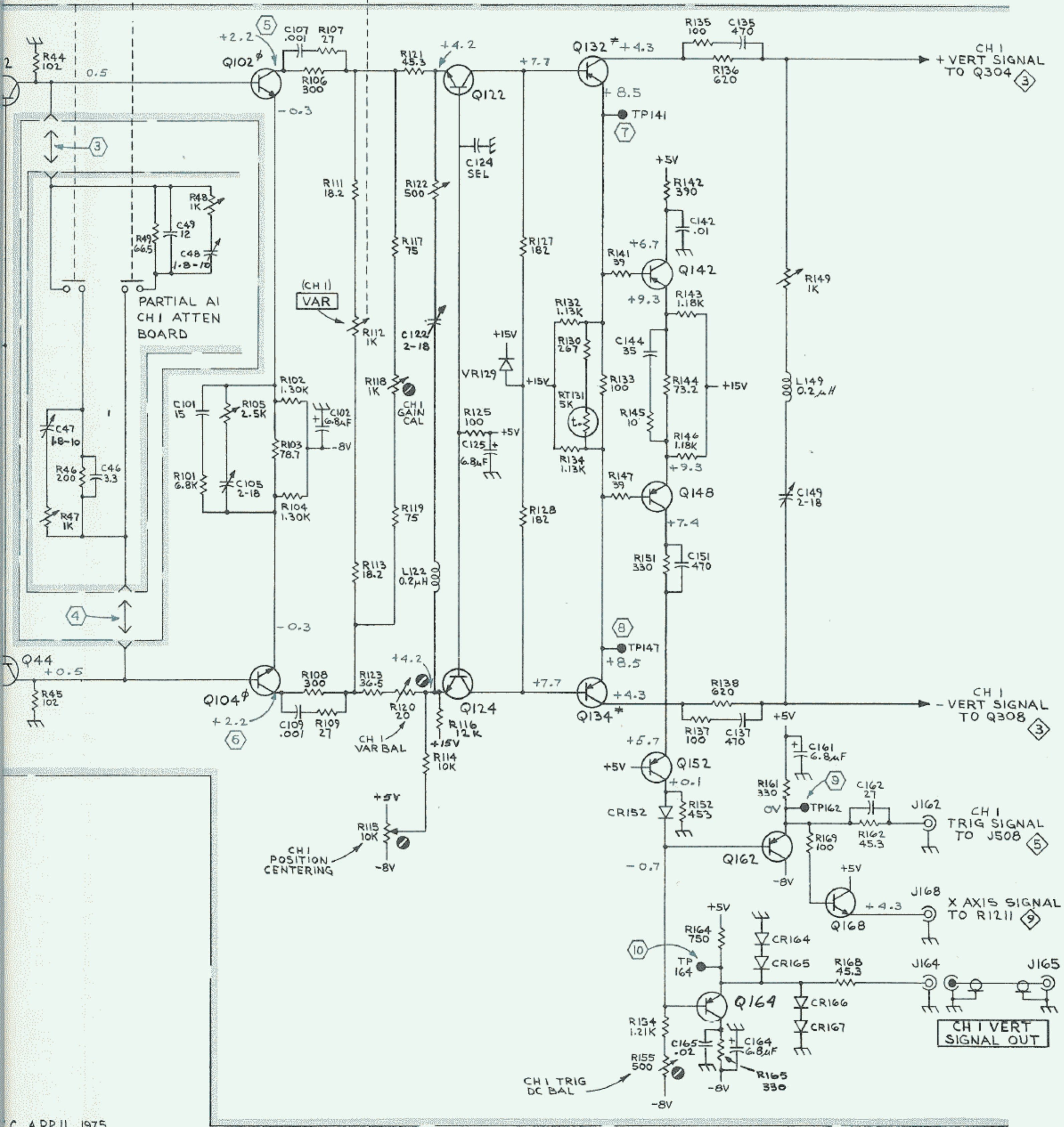
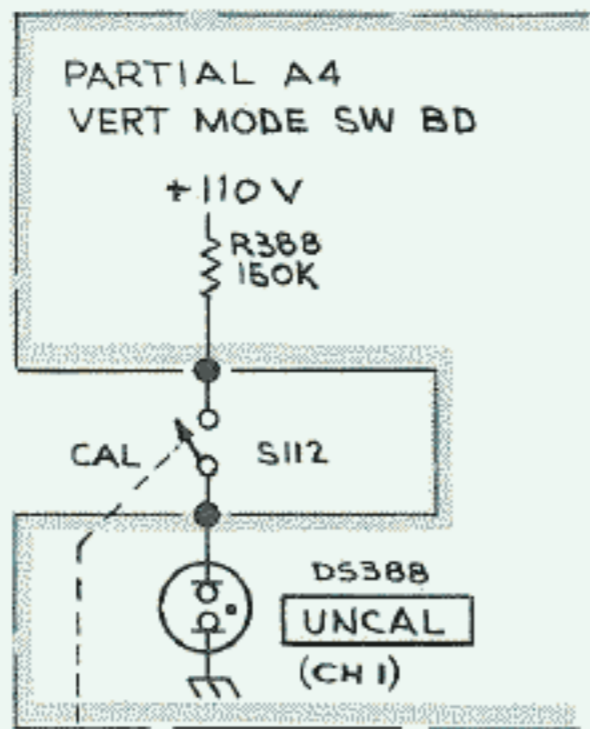
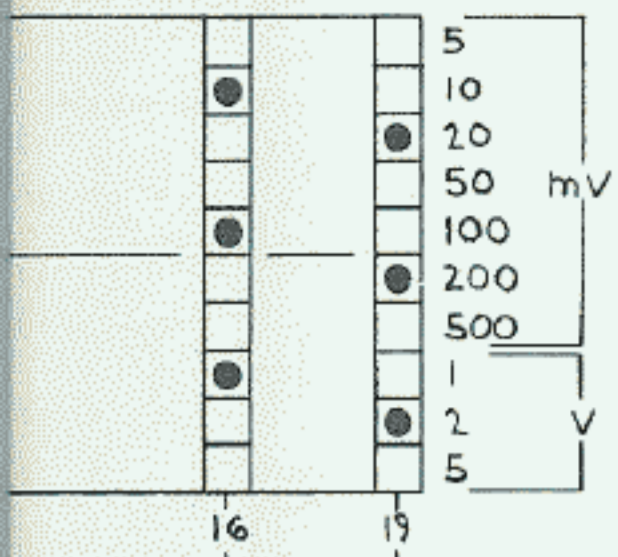

C, APRIL 1975

CH 1 VERTICAL PREAMP 1

SN B250000 and up

mgf 874

CH 1 VERTICAL PREAMP

1

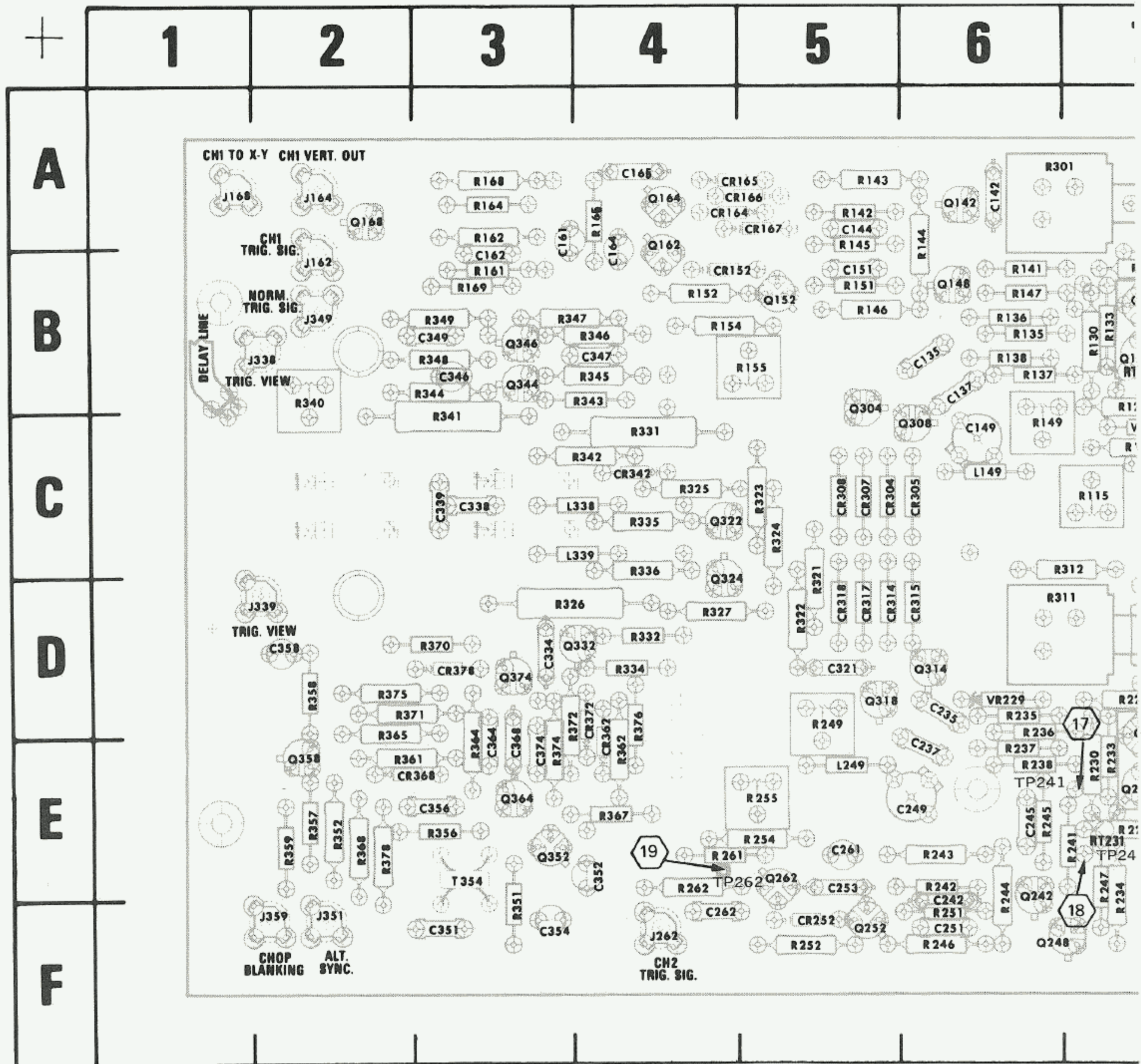

*See parts list for serial number ranges.

†Located on back of board.

‡Not used with 670-3023 Vertical Output Board.

Fig. 8-4. A1 & A2—Att

CKT NO	GRID LOC	CKT NO	GRID LOC	CKT NO	GRID LOC	CKT NO
C51	13F	C98	10D	CR68	11F	Q226
C52	13F	C99	10D	CR81	10F	Q228
C53	13E	C201	9D	CR82	10F	Q232
C56	13F	C202	10C	CR84	9F	Q234
†C57	13F	C205	8E	CR252	5F	Q248
C68	12F	C207	9D			Q252
C71	12F	C209	9E	J262	4F	Q262
C72	11E	C225	7F			Q314
C73	12E	†C229	7D	L249	5E	Q318
C75	12F	C235	6D			
C77	11F	C237	6E	Q70A	11F	R53
C82	9E	C242	6F	Q82	10E	R54
C83	10F	C245	6E	Q86	10F	R65
C84	9F	C249	6E	Q92	9E	R68
C87	9E	C251	6F	Q94	9E	R71
C88	9F	C253	5E	Q202	9D	R72
C92	8F	C261	5E	Q204	9E	R73
C96	11D	C262	4F	Q222	7E	R75
C97	11D			Q224	7E	R76



ASSEMBLIES A1, A2, A3 & A4

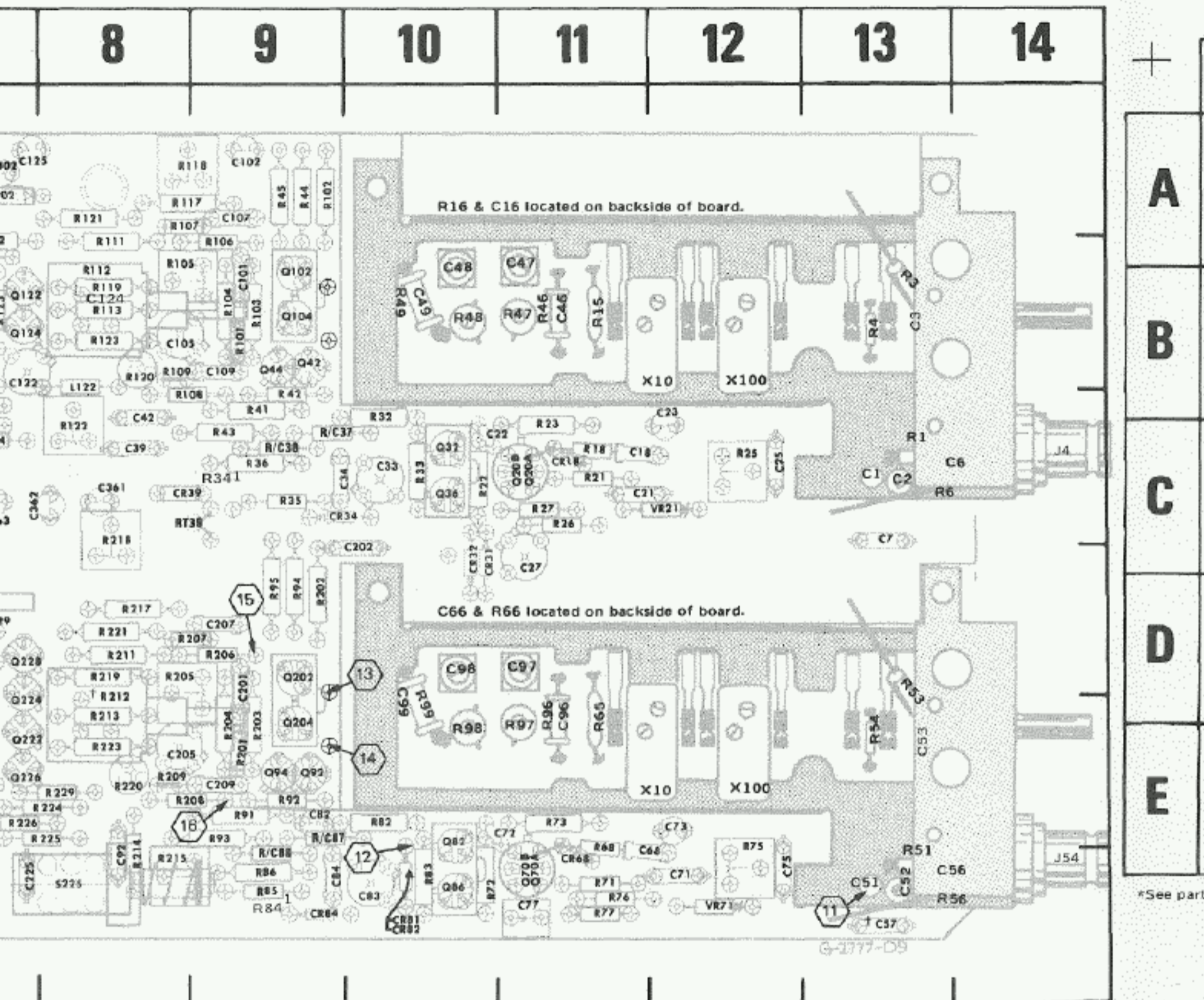

A

B

C

D

E

*See part

ors and A3—Vertical Preamp circuit boards.

GRID LOC	CKT NO	GRID LOC	CKT NO	GRID LOC	CKT NO	GRID LOC	CKT NO	GRID LOC
8E	R77	11F	R202	9D	R225	8E	R249	5D
9D	R82	10E	R203	9E	R226	7E	R251	6F
10F	R83	10F	R205	8D	R227	7E	R252	5F
9F	R84 ¹	9F	R206	9D	R228	7D	R254	5E
9F	R85	9F	R207	9D	R229	8E	R255	5E
9F	R86	9F	R208	9E	R230	7E	R261	4E
9E	R87	9E	R209	8E	R232	7D	R262	4E
9F	R88	9F	R211	8D	R234	7F		
9E	R91	9E	† R212	8E	R235	6D	RT39	9C
9E	R92	9E	R213	8E	R236	6D	RT231	7E
9E	R93	9E	R214	8F	R237	6E		
9D	R94	9D	R215	8F	R238	8E	VR71	12F
9D	R95	9D	R217	8D	R241	7E	VR229	6D
11E	R96	11E	R219	8D	R242	6E		
11E	R97	11E	R220	8E	R243	6E		
10E	R98	10E	R221	8D	R244	6E		
10E	R99	10E	R222	7E	R245	6E		
			R223	8E	R246	6F		
			R224	8E	R247	7E		

A3 VERTICAL PREAMP CIRCUIT BOARD
A4 VERT MODE CIRCUIT BOARD

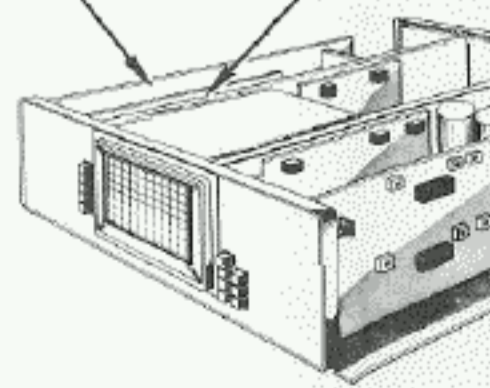

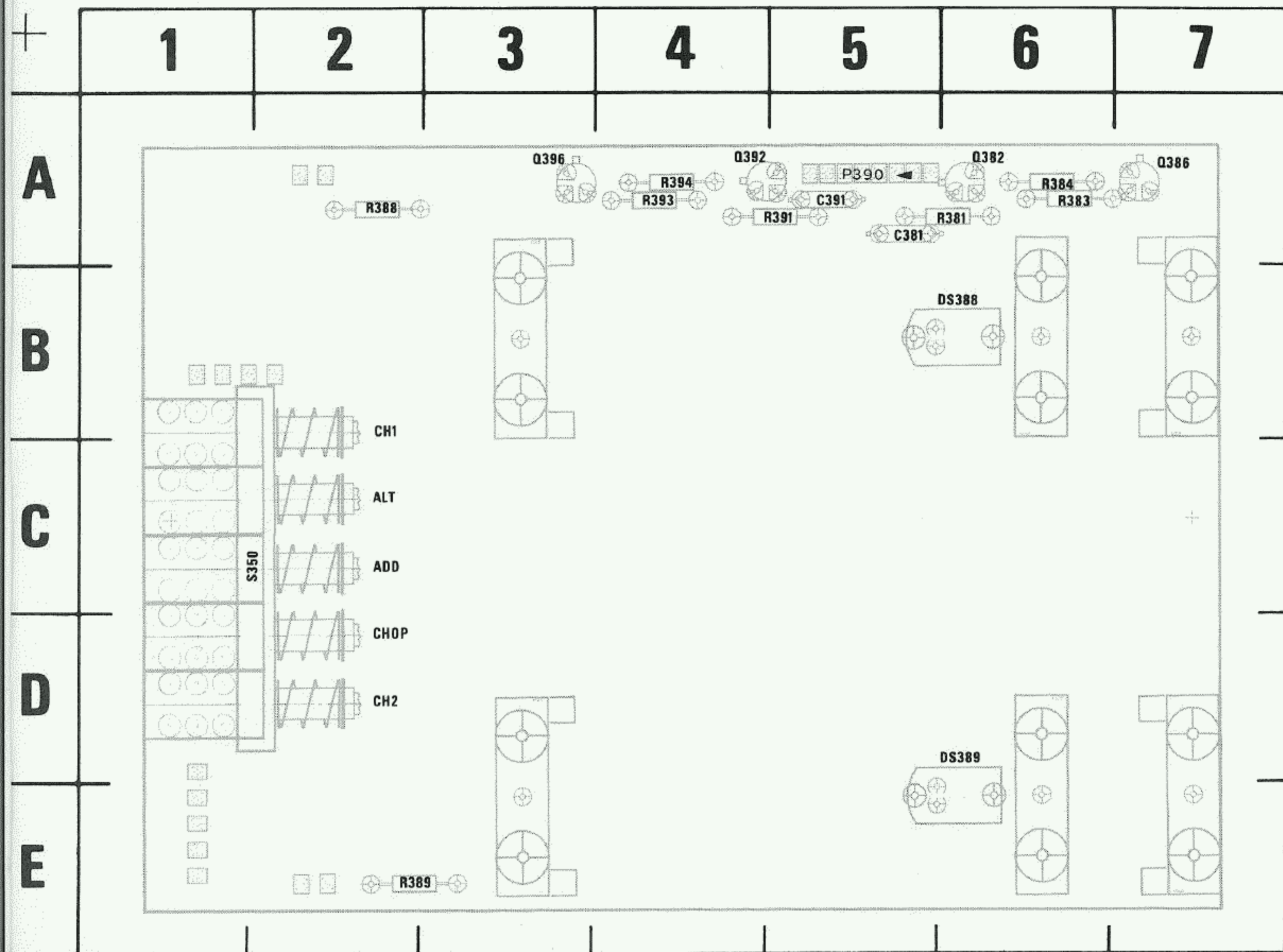

*See parts list for serial number ranges.

Fig. 8-5. A4-Vertical Mode Switch circuit board.

Located on back of board
R392

CKT NO	GRID LOC	CKT NO	GRID LOC
C381	5A	R381	6A
C391	5A	R383	6A
		R384	6A
DS388	6B	R388	2A
DS389	6D	R389	2E
P390	5A	R391	5A
Q382	6A	R393	4A
Q386	7A	R394	4A
Q392	4A		
Q396	3A	S350	1C

REV. A, JAN. 1975

IDE
BOARD

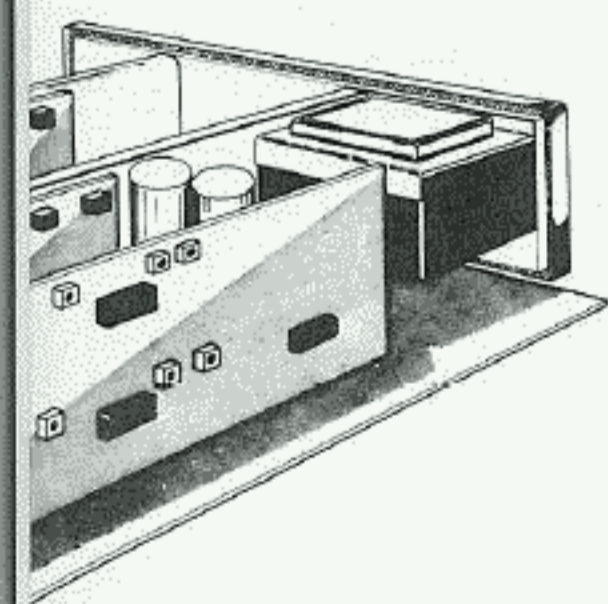

11

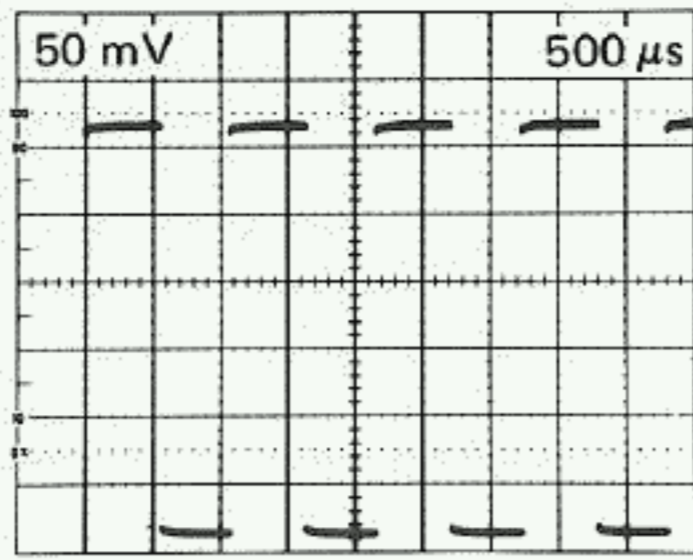

12

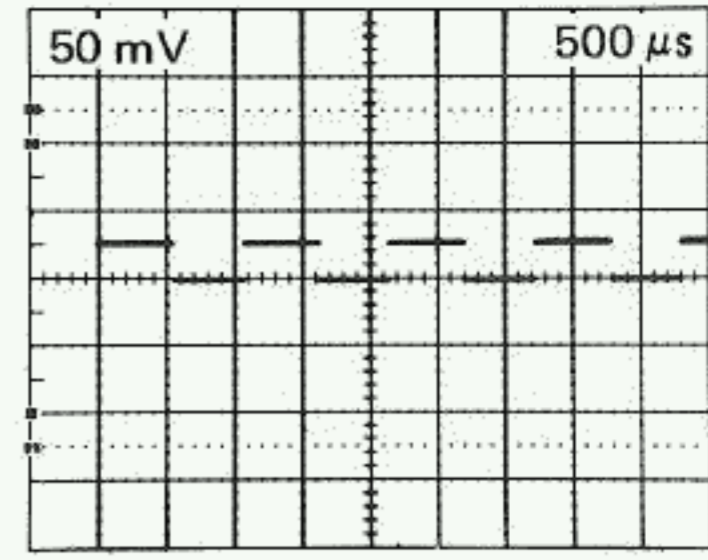

13

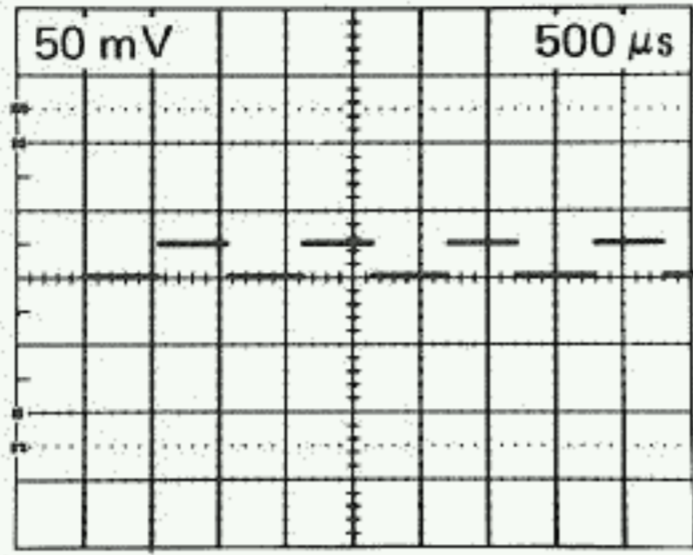

14

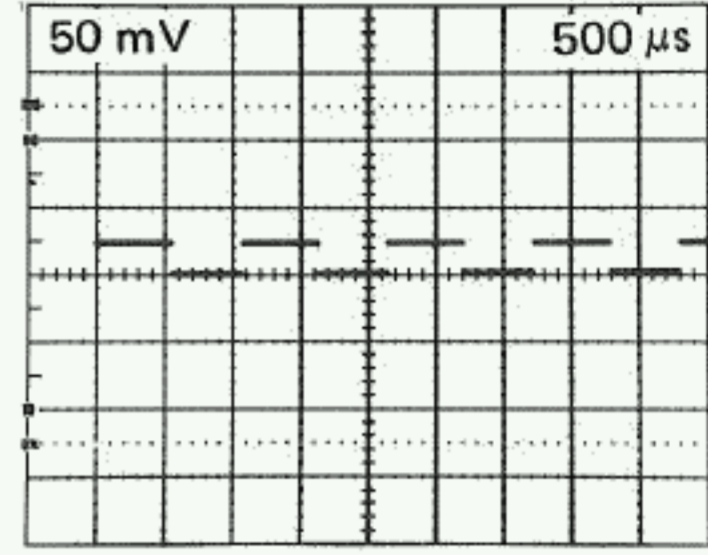

15

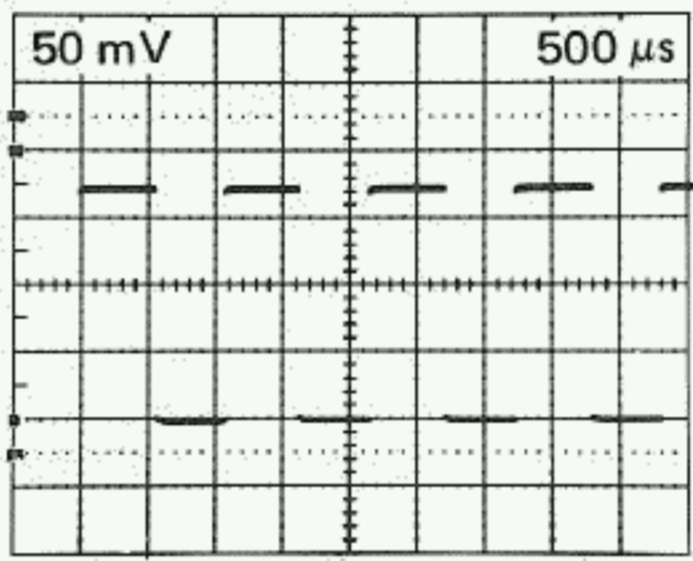

17

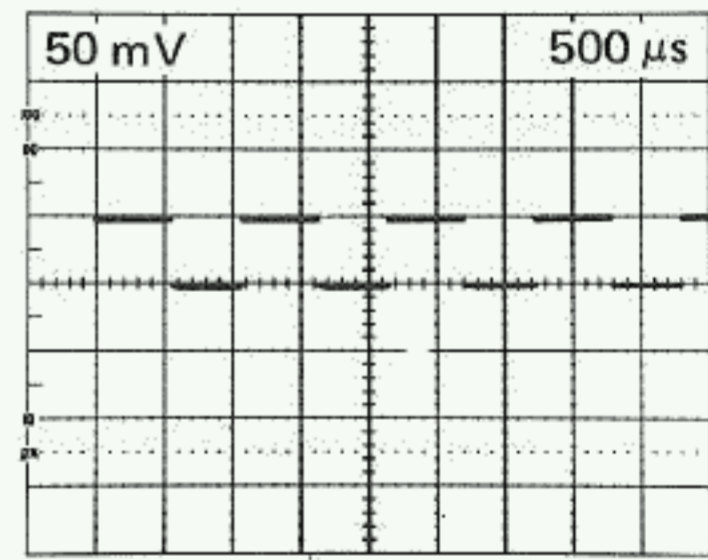

16

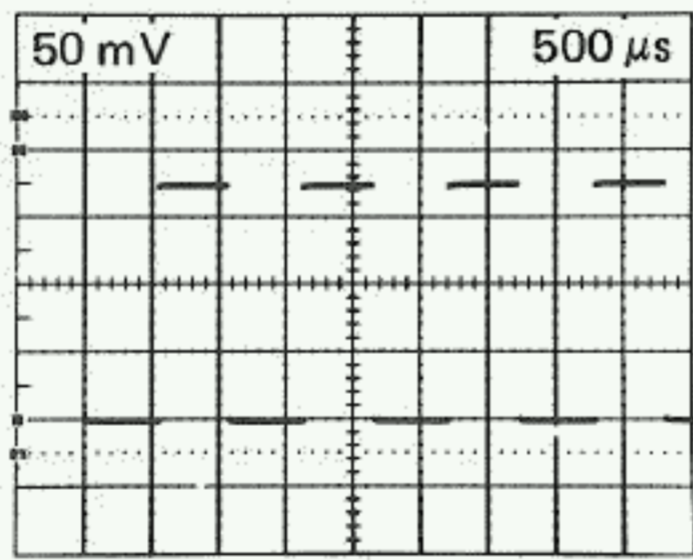

19

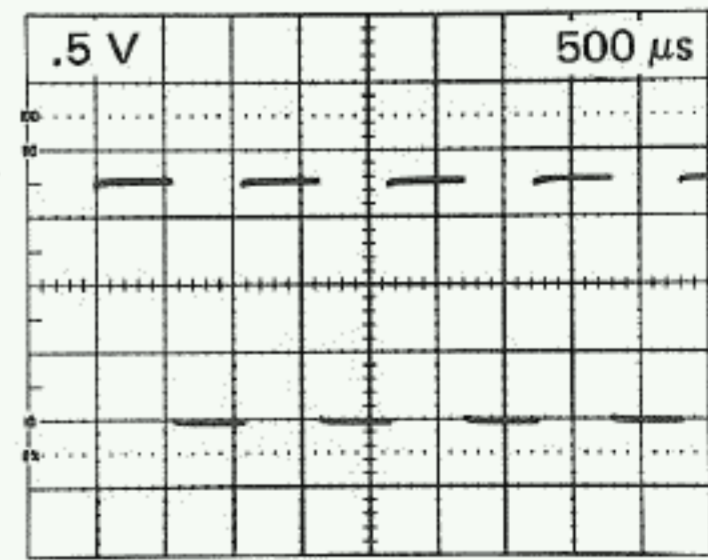

18

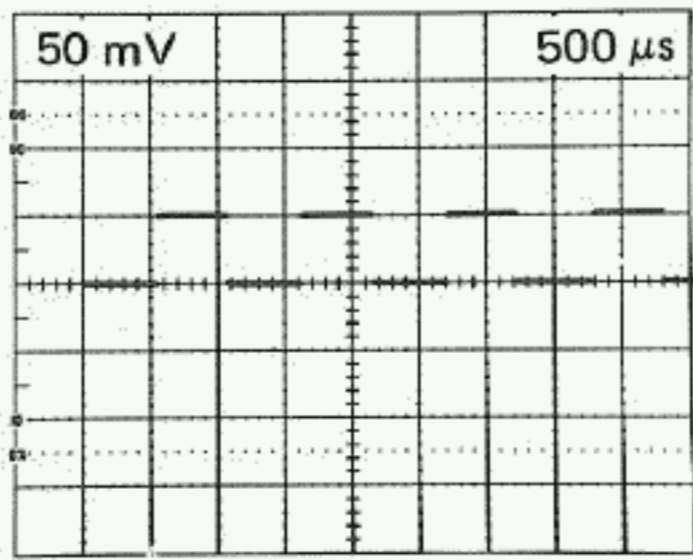

For waveforms 11 through 15. Connect the calibrator signal to the CH 2 input via a X10 probe. Set the VERT MODE switch to CH 2.

360
VOLTS/DIV (SHOWN IN 5mV POSITION)

(SHOWN IN AC POSITION)

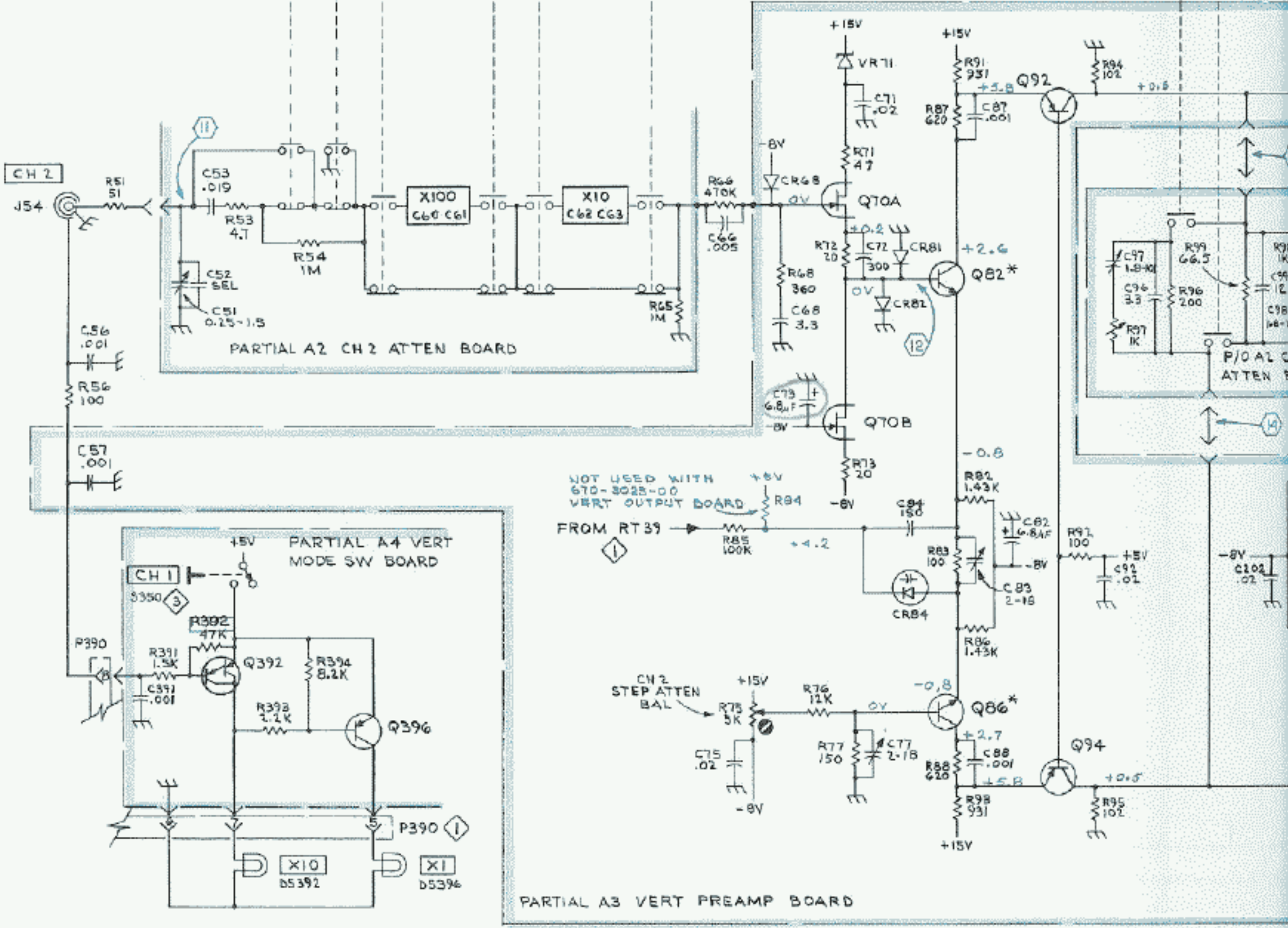
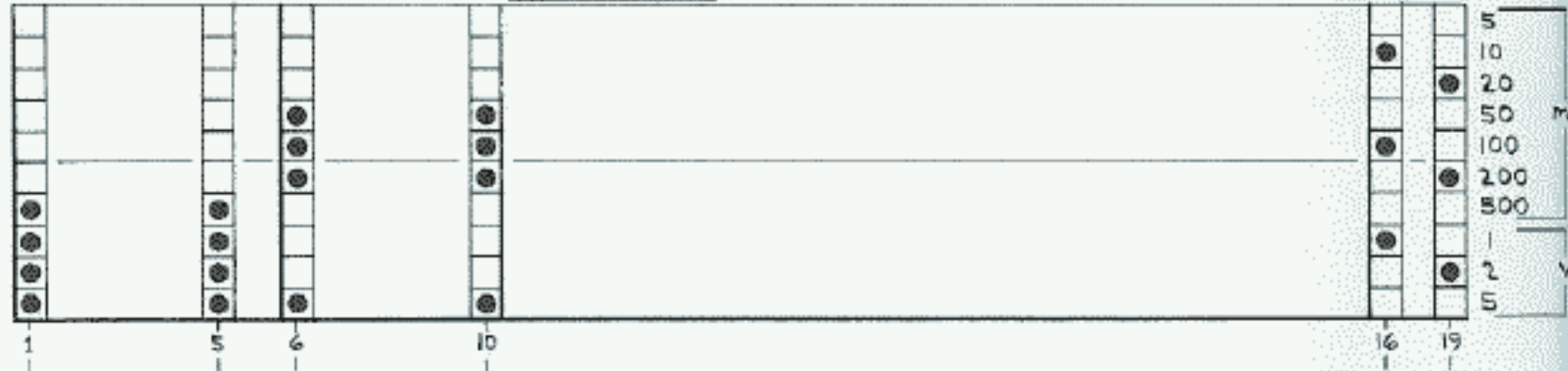

NOTES:
 φ, *, ≠ THERMAL COUPLED
 **, * MATCHED PAIR

SEE PARTS LIST FOR EARLIER VALUES AND SERIAL NUMBER RANGES OF PARTS MARKED WITH BLUE OUTLINE.

*Replaced
 C73
 6-17-77*

5	
10	
20	
50	mv
100	
200	
500	
1	v
2	
5	

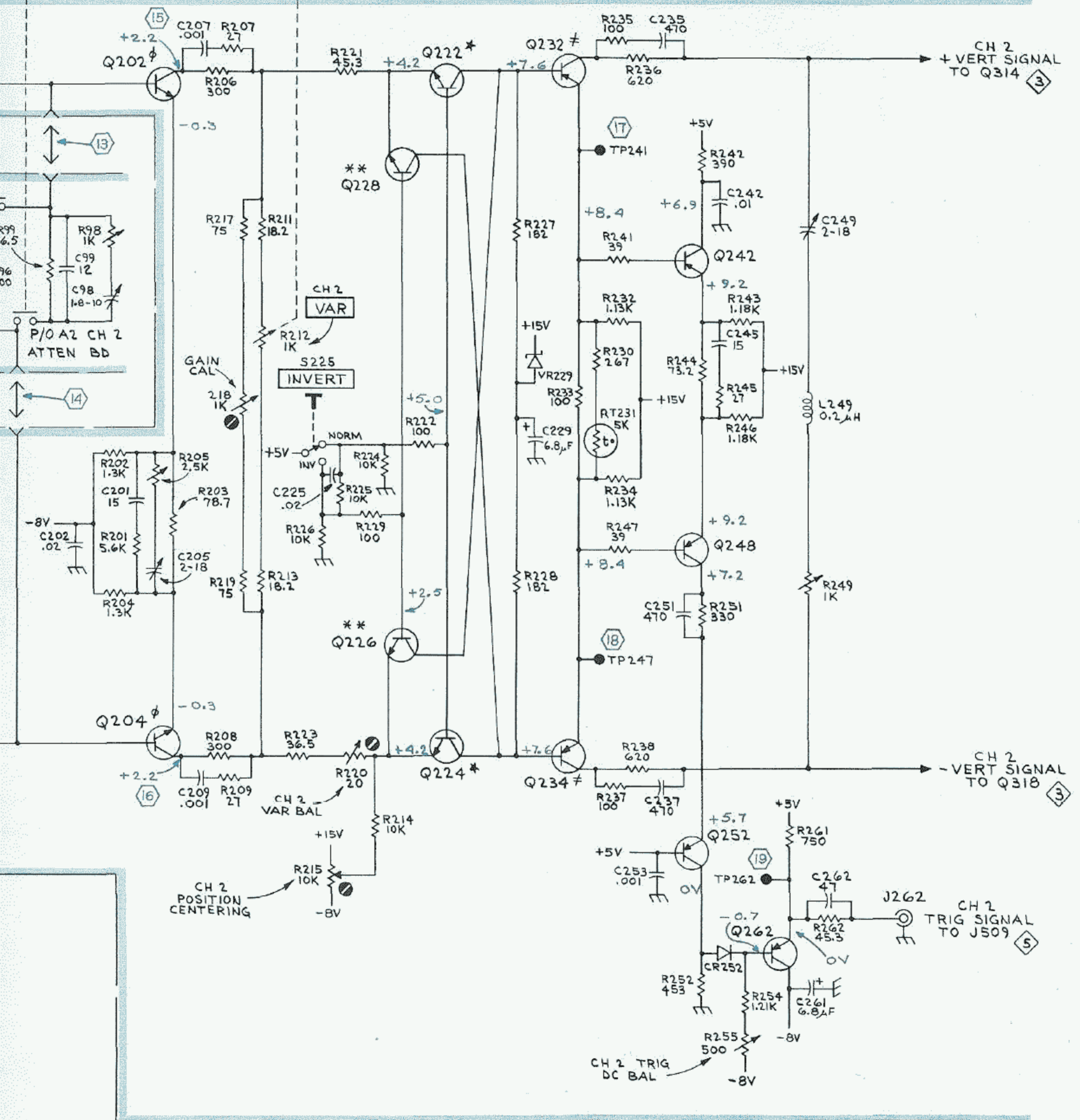
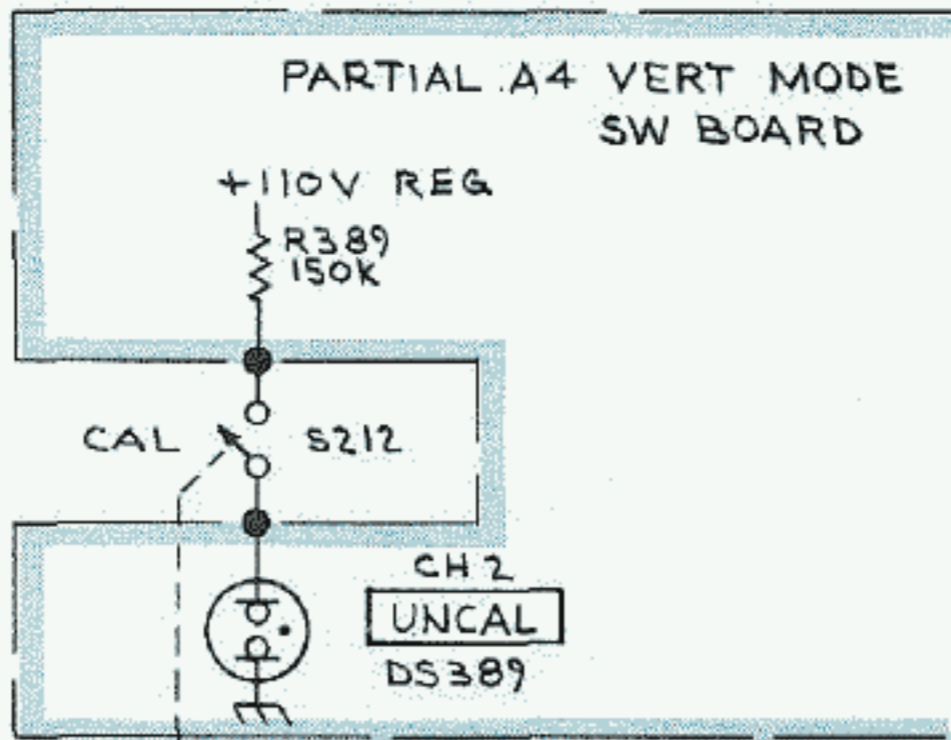

CH 2 VERTICAL PREAMP 2

mgf 674

SN B250000 and up

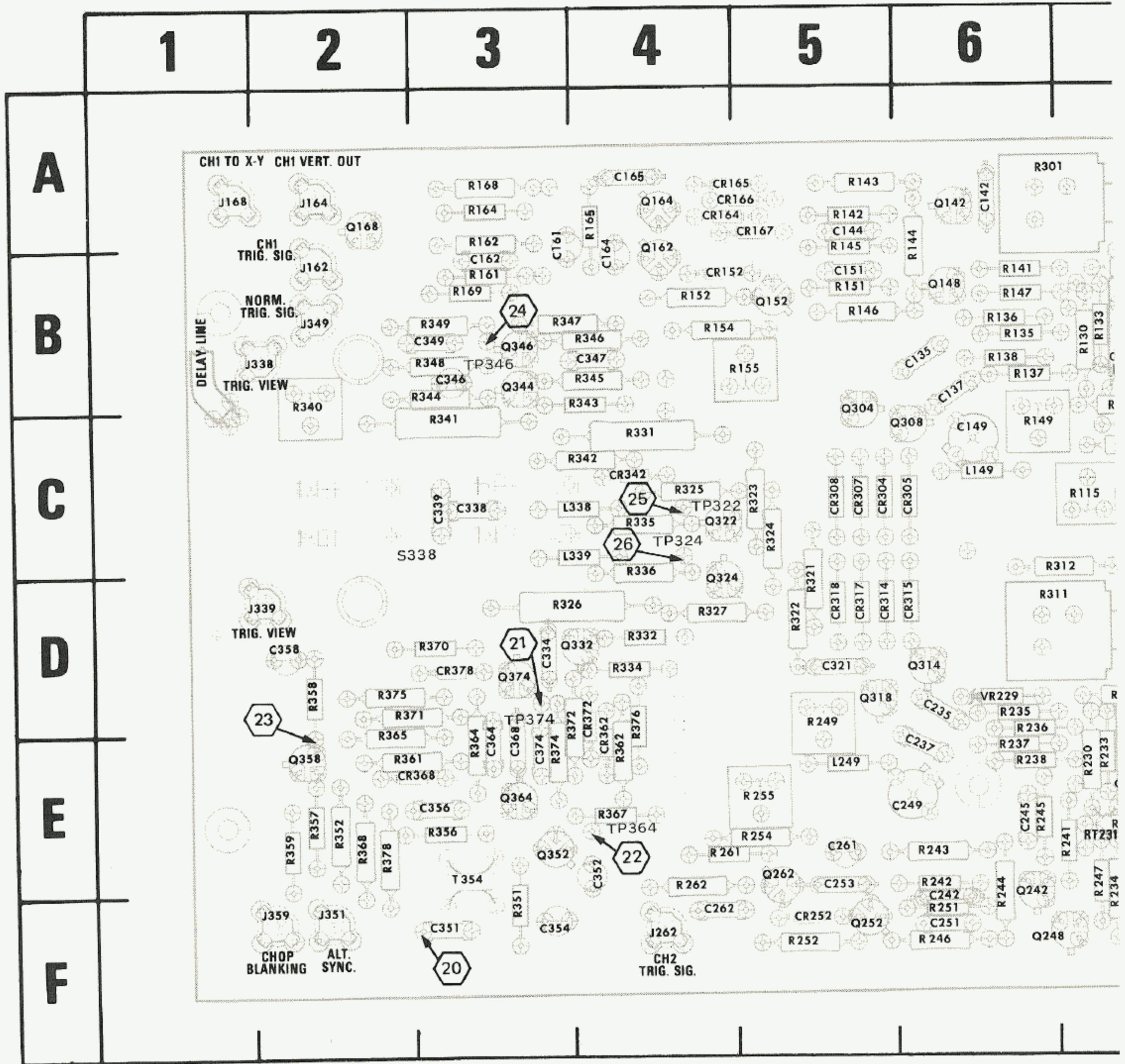

† Located on back of board
 † Not used with 670-3023 Vertical Output board

Fig. 8-6. A1 & A2-Atte



CKT NO	GRID LOC	CKT NO	GRID LOC
† C302	7A	R301	6A
C321	5D	R302	7A
C334	3D	R311	6D
C338	3C	R312	7C
C339	3C	R321	5D
C346	3B	R322	5D
C347	4B	R323	5C
C349	3B	R324	5C
C351	3F	R325	4C
C352	4E	R326	3D
C354	3F	R327	4D
C356	3E	R331	4C
C358	2D	R332	4D
C361	8C	R334	4D
C362	7C	R335	4C
C363	7C	R336	4C
C364	3E	R340	2B
C368	3E	R341	3C
C374	3E	R342	4C
		R343	4B
CR304	5C	R344	3B
CR305	6C	R345	4B
CR307	5C	R346	4B
CR308	5C	R347	3B
CR314	5D	R348	3B
CR315	6D	R349	3B
CR317	5D	R351	3F
CR318	5D	R352	2E
CR342	4C	R356	3E
CR362	4D	R357	2E
CR368	3E	R358	2D
CR372	4D	R359	2E
CR378	3D	R361	2E
		R362	4E
J338	2B	R364	3E
J339	2D	R365	2D
J351	2F	R367	4E
J359	2F	R368	2E
		R370	3D
L338	4C	R371	2D
L339	4C	R372	3D
		R374	3E
Q304	5B	R375	2D
Q308	6C	R376	4D
Q314	6D	R378	2E
Q318	5D		
Q322	4C	S338	2C
Q324	4D		
Q332	4D	T354	3E
Q344	3B		
Q346	3B	TP322	4C
Q352	3E	TP324	4C
Q358	2E	TP346	3B
Q364	3E	TP364	4E
Q374	3D	TP374	3D

@

20

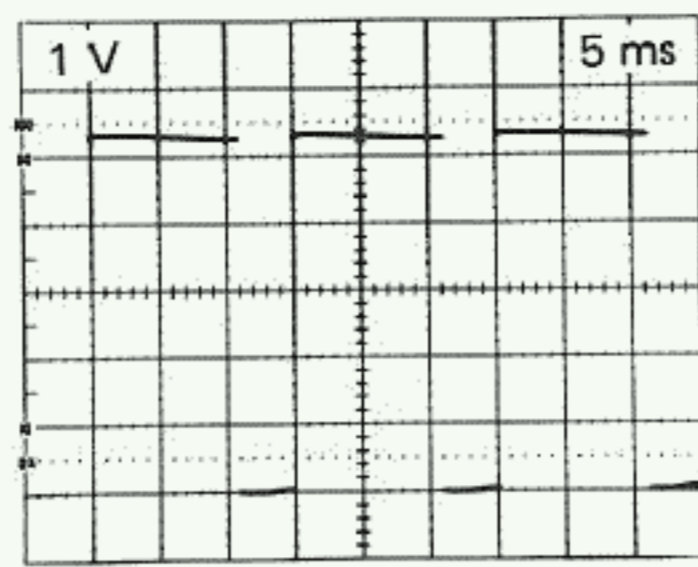

21

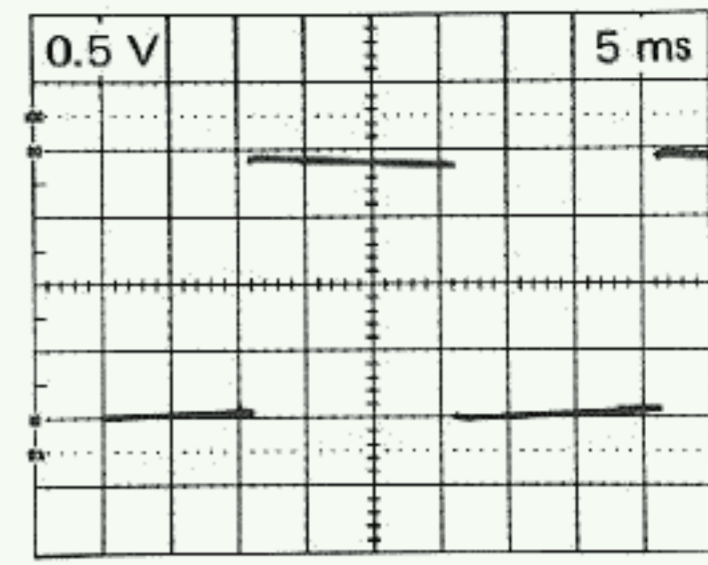

Set the VERT MODE switch to ALT and the A SOURCE switch to CH 1.

22

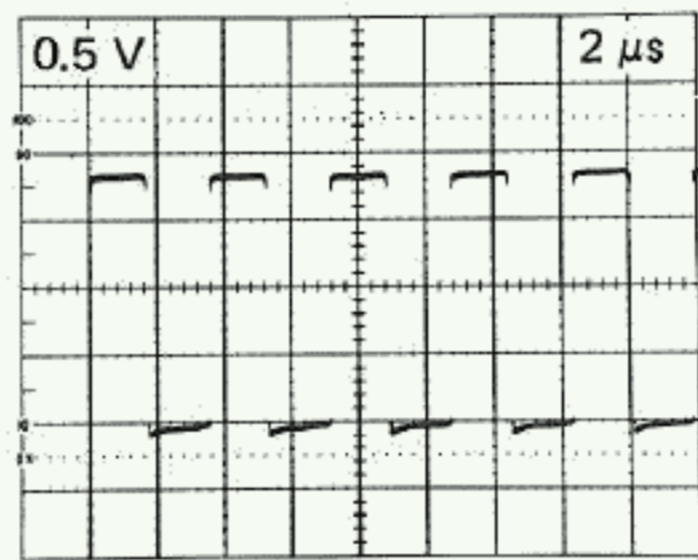

Set the 465 VERT MODE switch to CHOP.

Set the test scope Trigger Source switch to Normal.

23

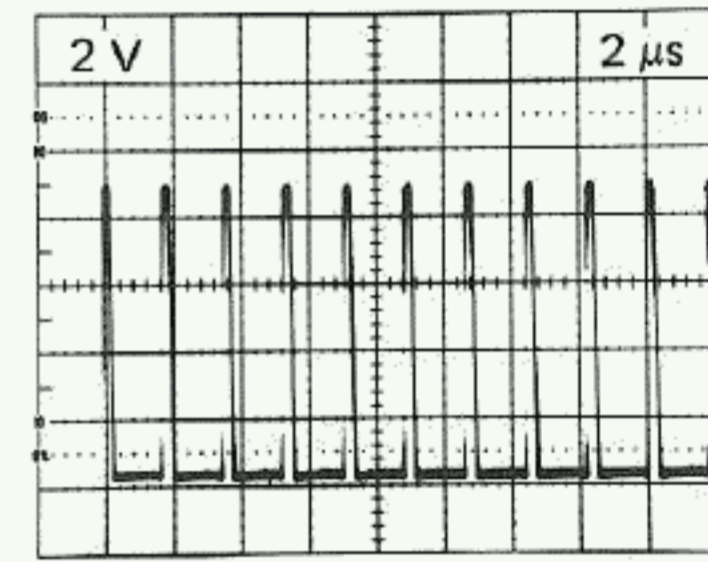

Set the 465 VERT MODE switch to CHOP.

Set the test scope Trigger Source switch to Normal.

24

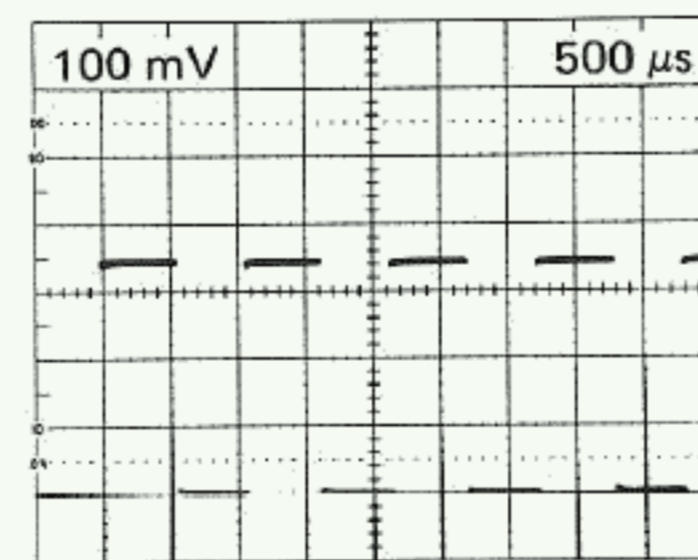

25

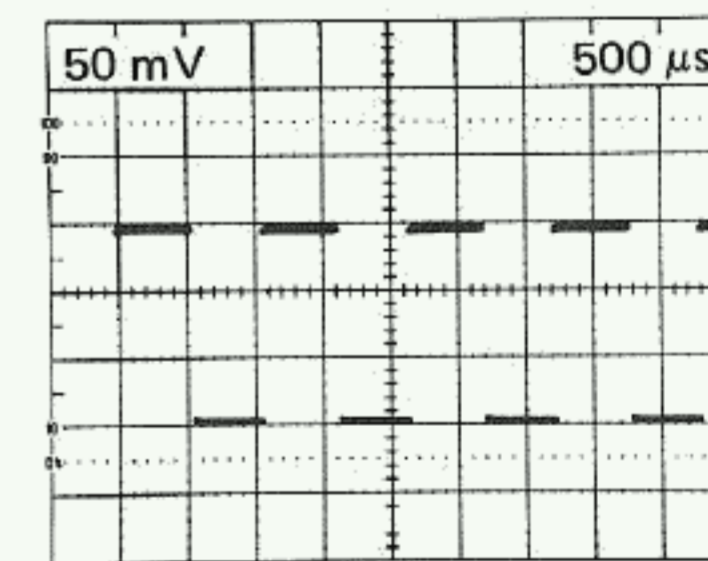

26

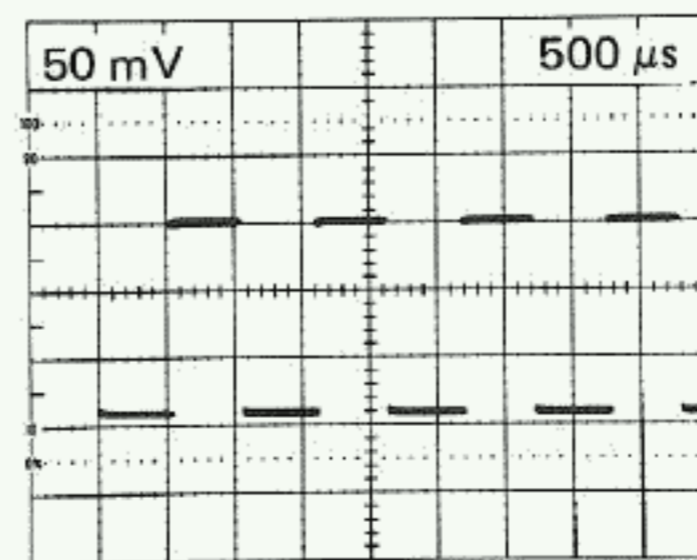

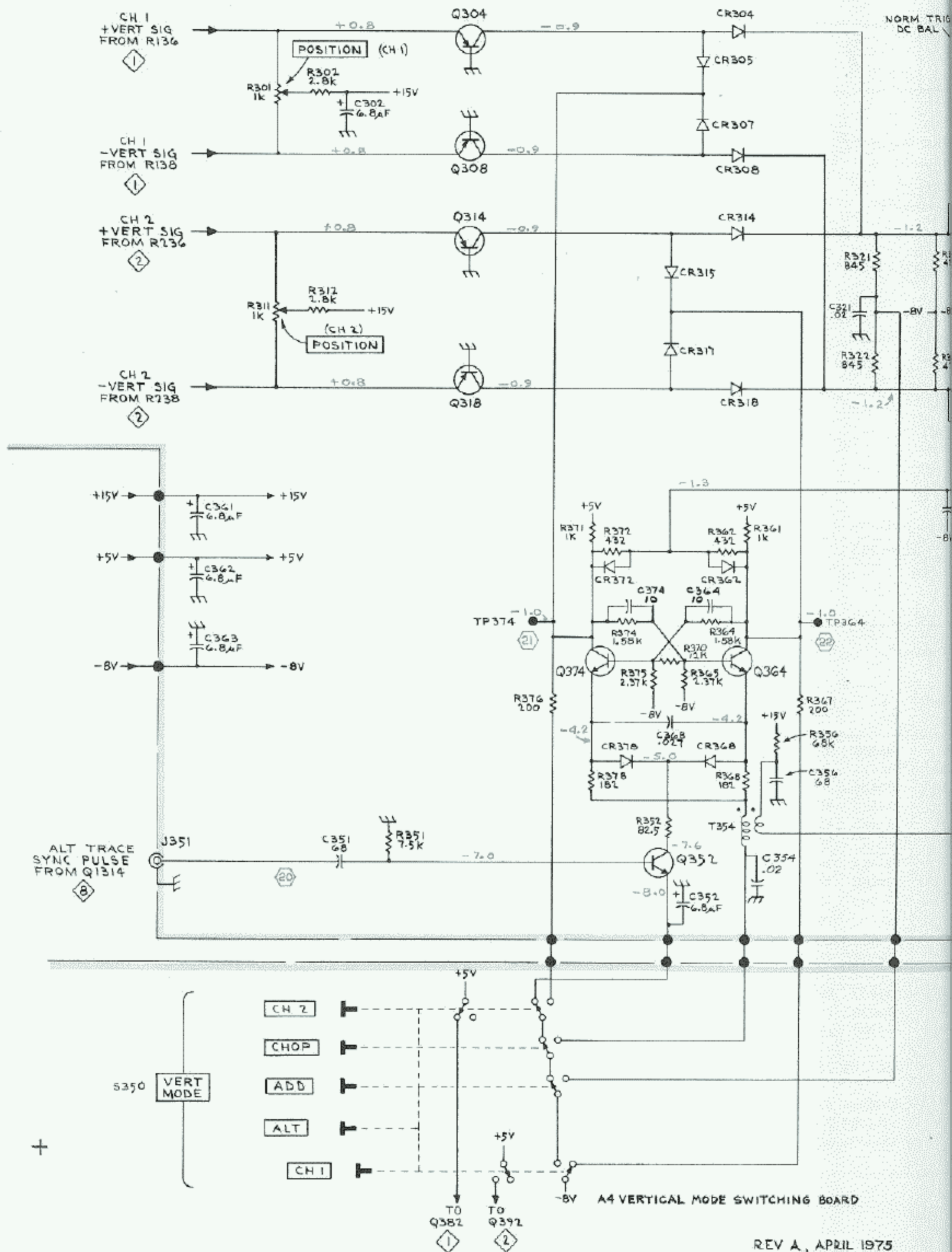

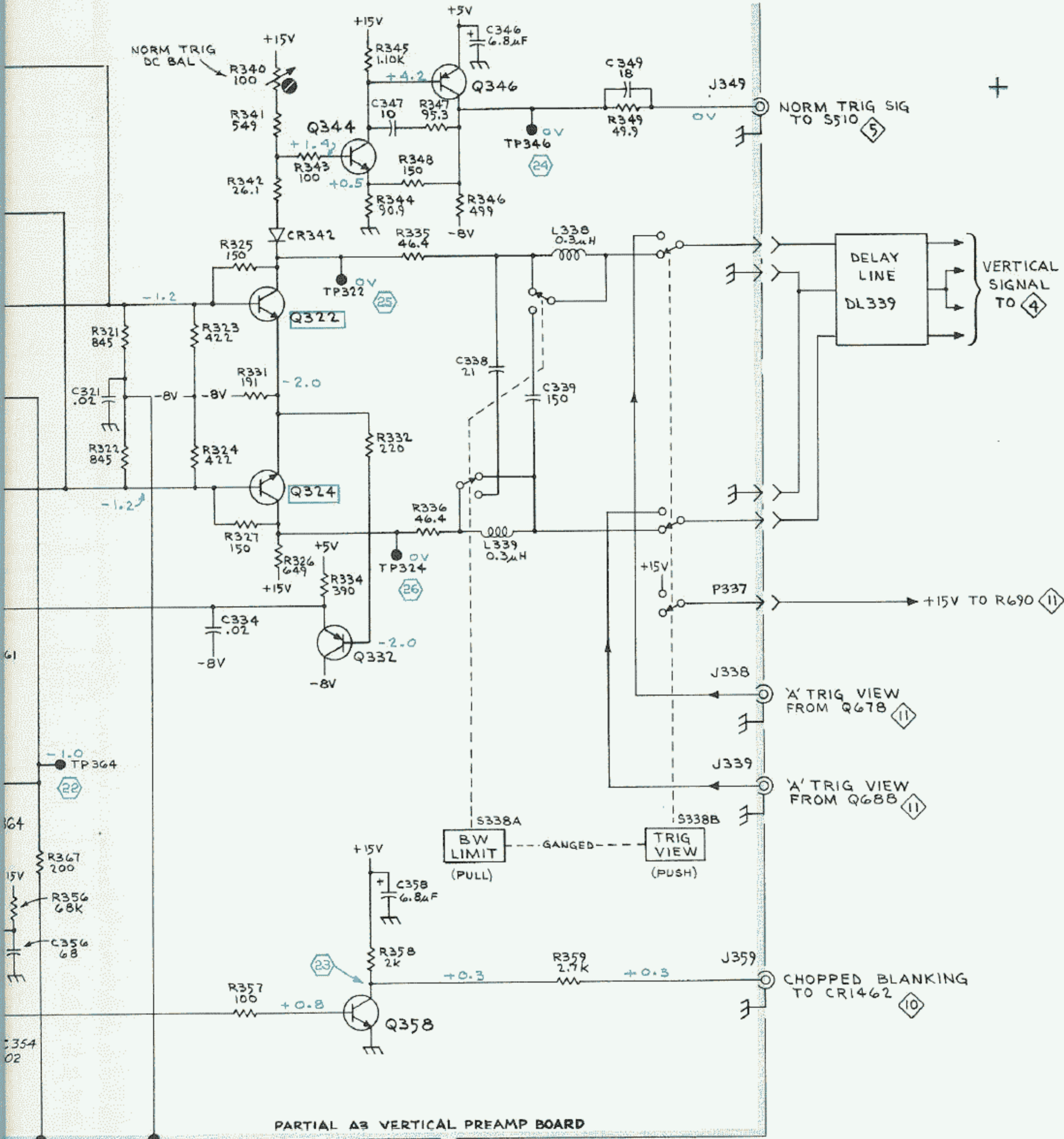

PARTIAL A3 VERTICAL PREAMP BOARD

SEE PARTS LIST FOR EARLIER VALUES AND SERIAL NUMBER RANGES OF PARTS MARKED WITH BLUE OUTLINE.

SEE PARTS LIST FOR SEMICONDUCTOR TYPES.

CHING BOARD

EV A, APRIL 1975

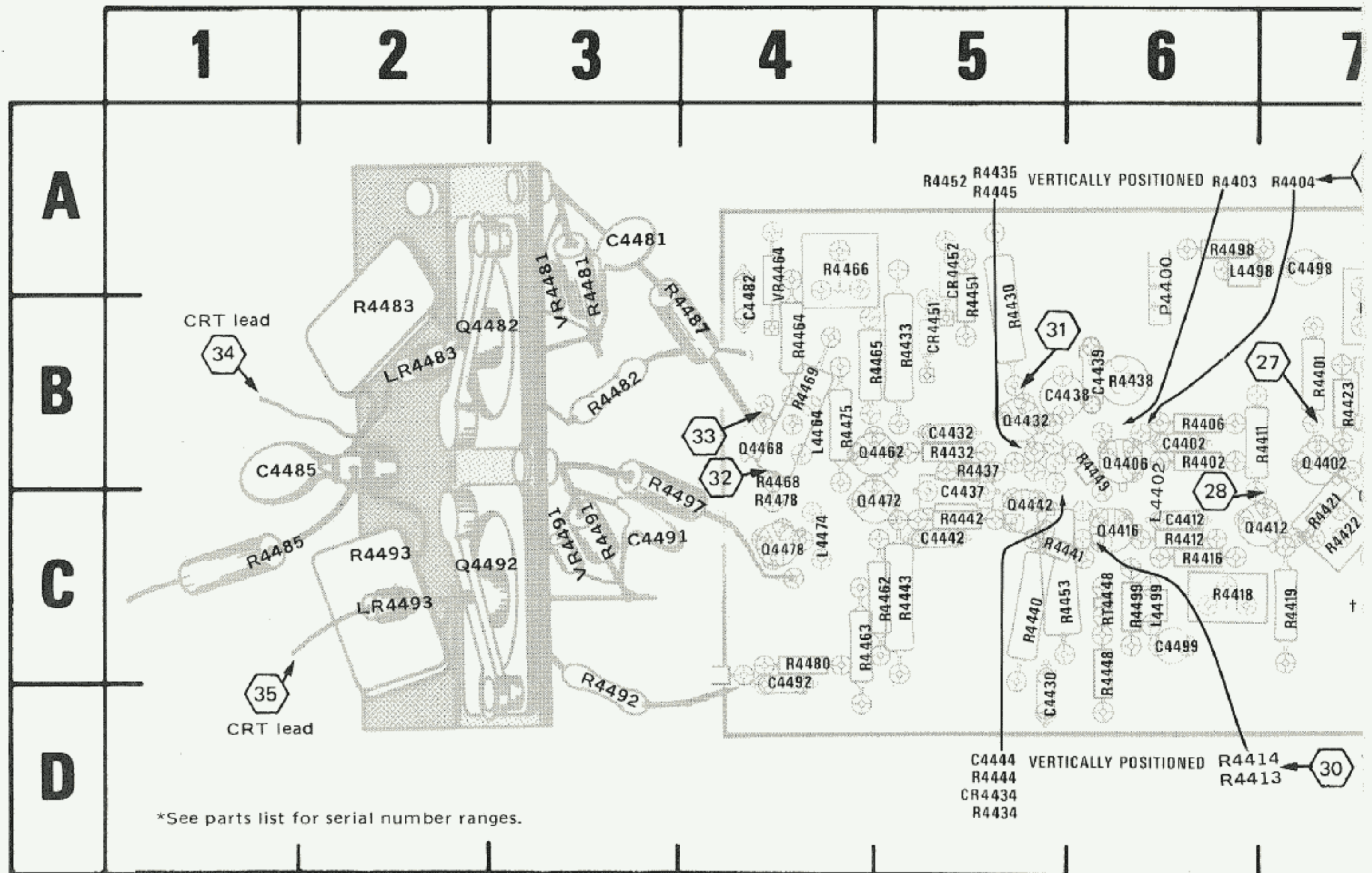

Fig. 8-7. A5a—Vertical Output Amplifier circuit board (discrete version).

CKT NO	GRID LOC	CKT NO	GRID LOC	CKT NO	GRID LOC	CKT NO	GRID LOC	CKT NO
C4402	6B	L4402	6B	R4401	7B	R4433	5B	R4469
C4412	6C	L4464	4B	R4402	6B	R4434	5D	R4474
C4422	7C	L4474	4C	R4403	6A	R4435	5A	R4475
C4425	7B	L4498	6A	R4404	7A	R4436	8C	R4478
C4427	7B	L4499	6C	R4406	7B	R4437	5B	R4480
C4430	5D			R4408	8D	R4438	6B	R4481
C4432	5B	LR4483	2B	R4409	7B	R4440	5C	R4482
C4437	5B	LR4493	2C	R4411	6B	R4441	5C	R4483
C4438	5B			R4412	6C	R4442	5C	R4485
C4439	6B	P4400	6A	R4413	6D	R4443	5C	R4487
C4442	5C			R4414	6D	R4444	5D	R4491
C4444	5D	Q4402	7B	R4416	6C	R4445	5A	R4492
C4481	3A	Q4406	6B	R4418	6C	R4448	6C	R4493
C4482	4A	Q4412	6C	R4419	7C	R4449	6B	R4497
C4485	1B	Q4416	6C	R4421	7C	R4451	5B	R4498
C4491	3C	Q4432	5B	R4422	7C	R4452	5A	R4499
C4492	4D	Q4442	5C	R4423	7B	R4453	5C	
C4498	7A	Q4462	4B	R4424	7C	R4462	5C	RT4448
C4499	6C	Q4468	4B	R4425	8C	R4463	4C	
		Q4472	5C	R4427	7B	R4464	4B	VR4464
CR4434	5D	Q4478	4C	R4430	5B	R4465	4B	VR4481
CR4451	5B	Q4482	2B	R4431	8C	R4466	4A	VR4491
CR4452	5A	Q4492	2C	R4432	5B	R4468	4B	



8

9

29 Junction of R4403 and R4404.

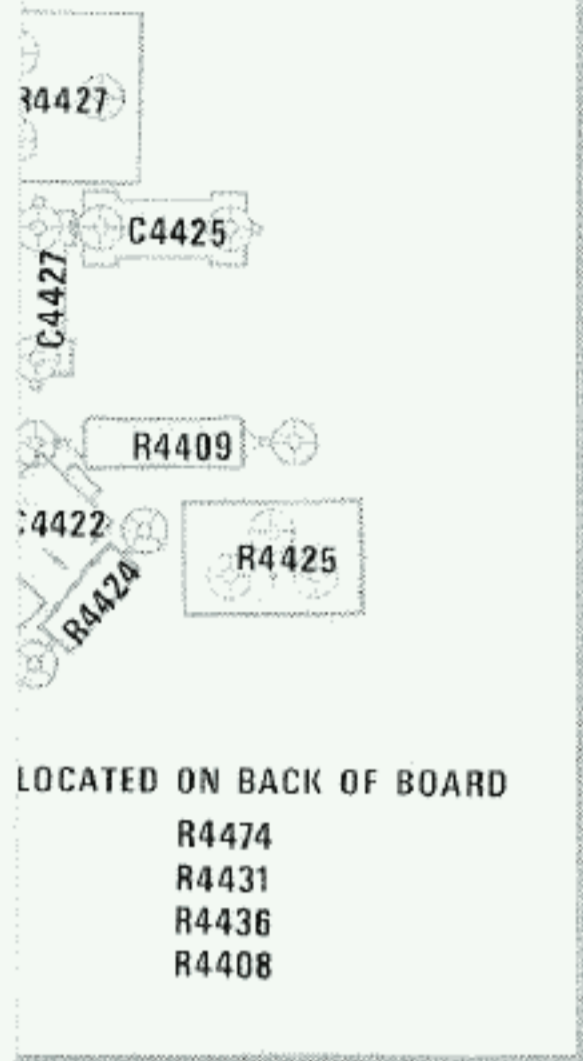

Junction of R4414 and R4413.

GRID
LOC

- 4B
- 8C
- 4B
- 4C
- 4C
- 3A
- 3B
- 2A
- 1C
- 3B
- 3C
- 3D
- 2C
- 3B
- 6A
- 6C
- 6C
- 4A
- 3A
- 3C

A5
VERTICAL OUTPUT
CIRCUIT BOARD

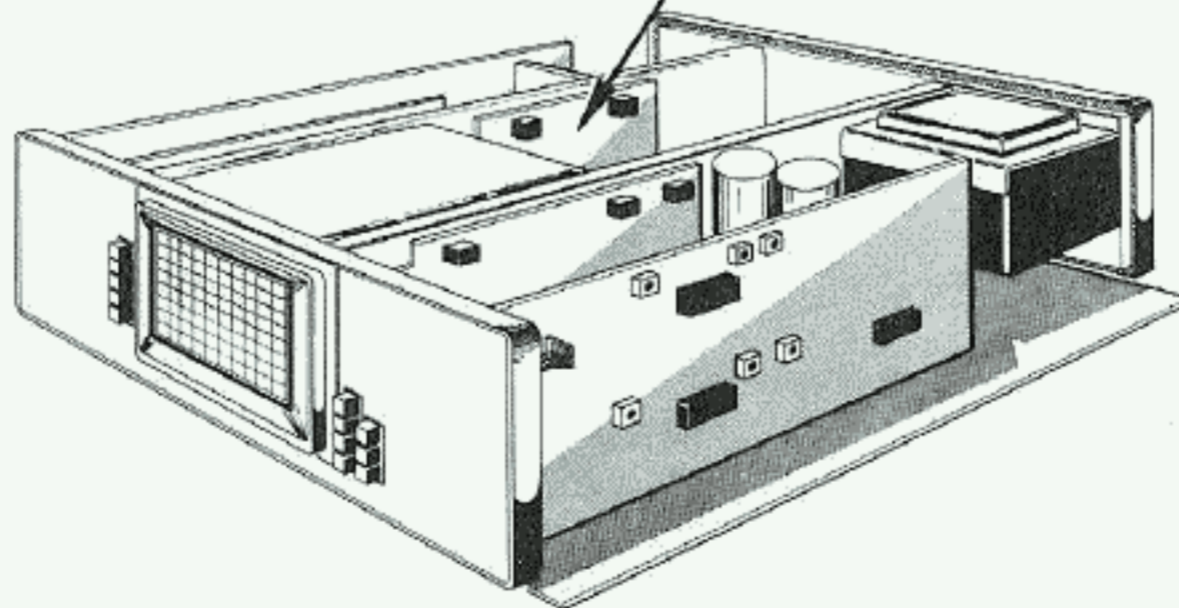

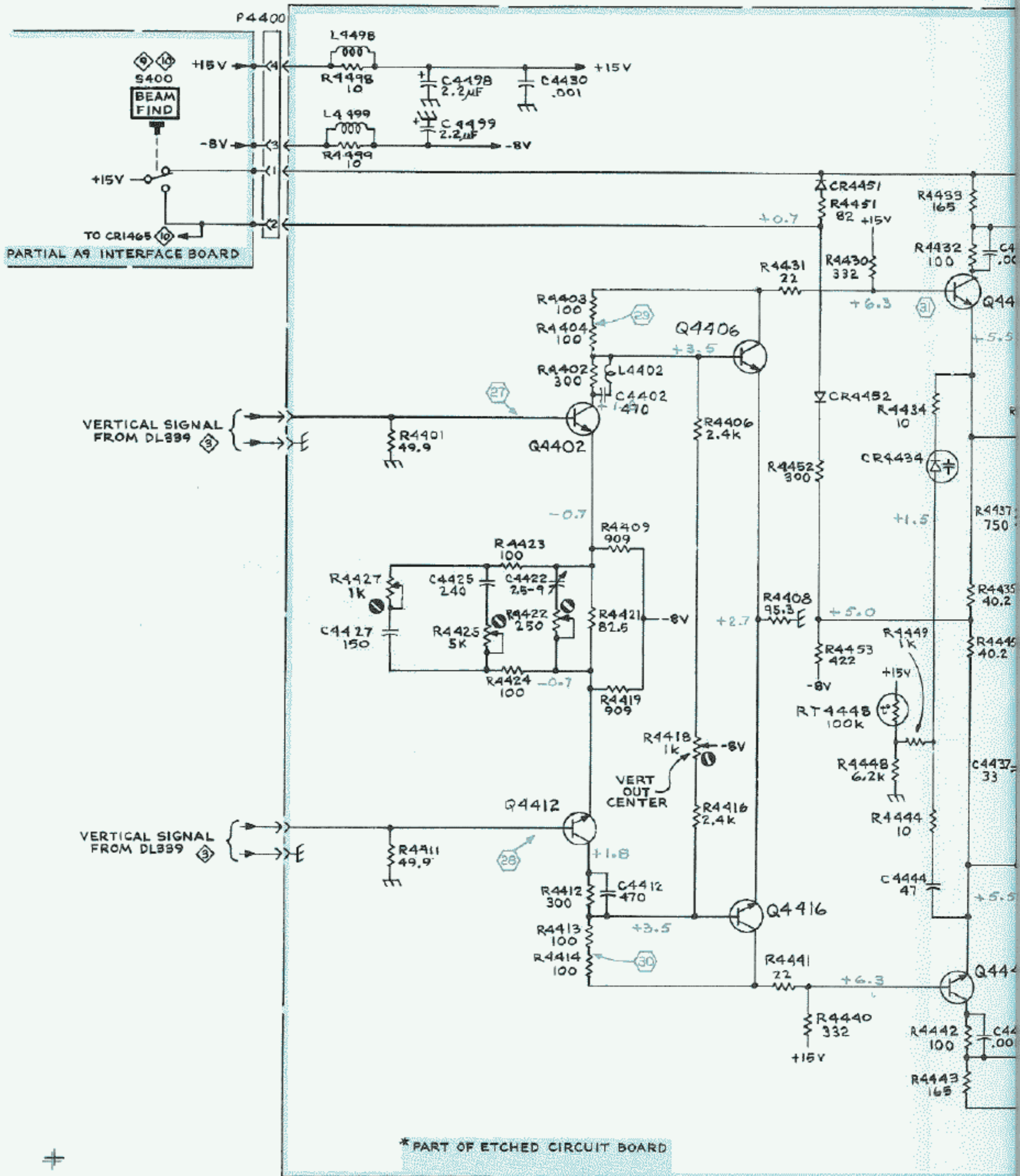

+

+

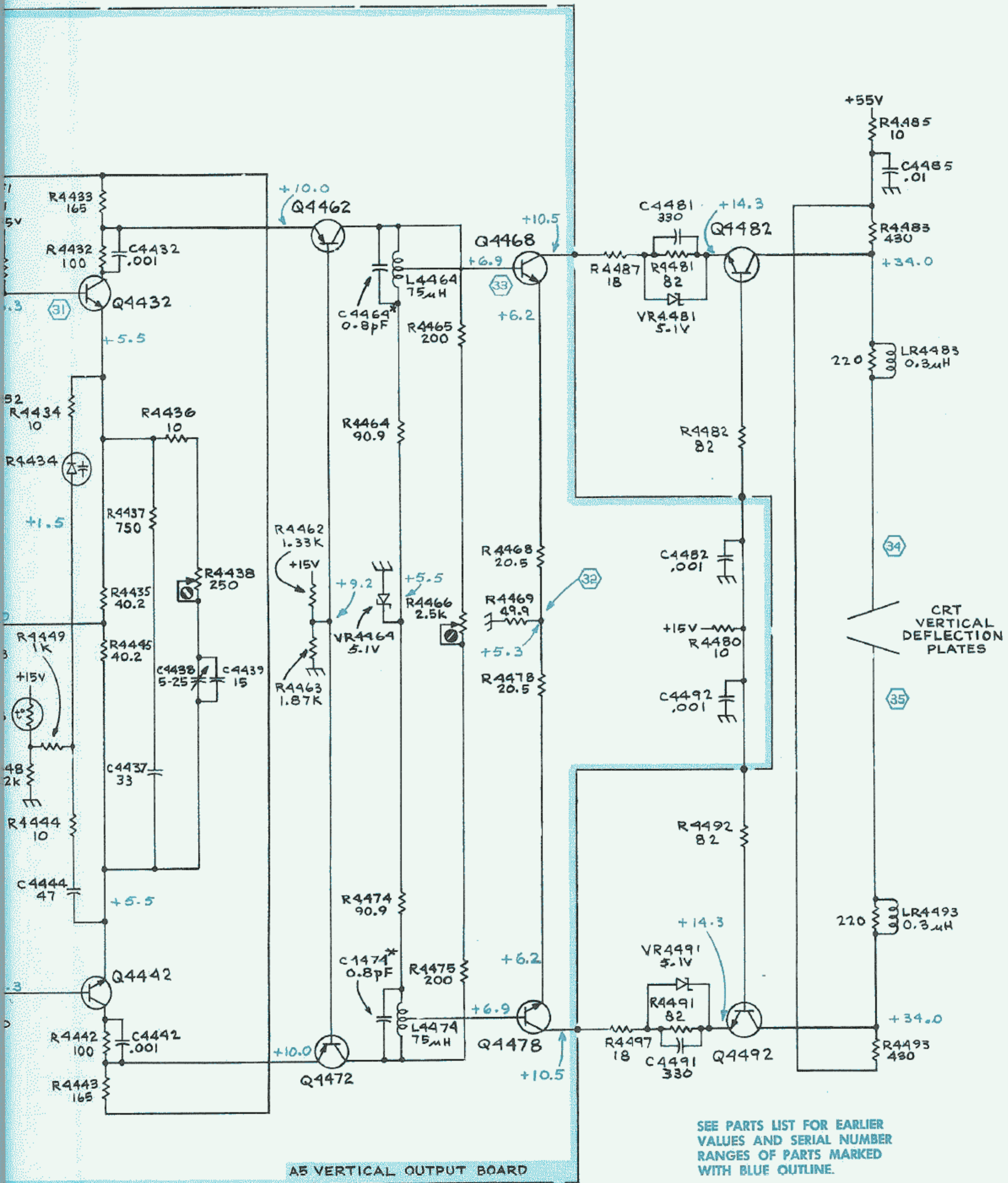

A5 VERTICAL OUTPUT BOARD

SEE PARTS LIST FOR EARLIER VALUES AND SERIAL NUMBER RANGES OF PARTS MARKED WITH BLUE OUTLINE.

SEE PARTS LIST FOR SEMICONDUCTOR TYPES.

VERTICAL OUTPUT AMP (DISCRETE VERSION)



VERTICAL OUTPUT AMPLIFIER (DISCRETE VERSION) 4_a

SN B250000 and up
670-3023-

874
KLP

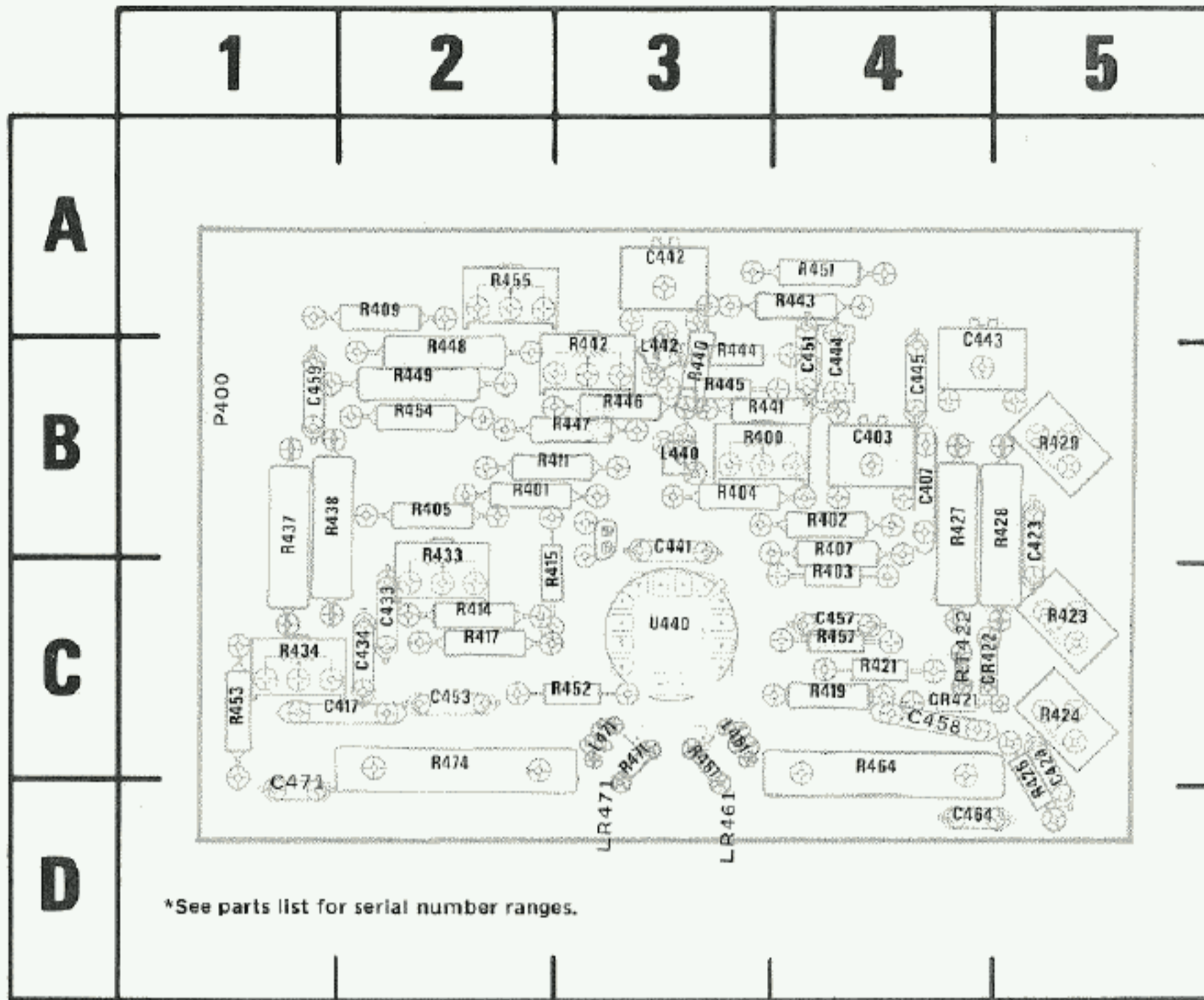

Fig. 8-8. A5b—Vertical Output Amplifier circuit board (IC version).

CKT NO	GRID LOC	CKT NO	GRID LOC	CKT NO	GRID LOC	CKT NO	GRID LOC
C403	4B	CR421	4C	R409	2A	R442	3A
C407	4B	CR422	4C	R411	3B	R443	4A
C417	2C			R414	2C	R444	3B
C423	5B	L440	3B	R415	2C	R445	3B
C424	5C	L442	3A	R417	2C	R446	3B
C433	2C	L461	3C	R419	4C	R447	3B
C434	2C	L471	3C	R421	4C	R448	2A
C441	3B	LR461	3D	R423	5C	R449	2B
C442	3A	LR471	3D	R424	5C	R451	4A
C443	5A			R426	5C	R452	3C
C444	4B	P400	1B	R427	4B	R453	1C
C445	4B			R428	5B	R454	2B
C451	4B	R400	3B	R429	5B	R455	2A
C453	2C	R401	2B	R433	2B	R457	4C
C457	4C	R402	4B	R434	1C	R461	3C
C458	4C	R403	4C	R437	1B	R464	4C
C459	1B	R404	3B	R438	1B	R471	3C
C464	4D	R405	2B	R440	3B	R474	2D
C471	1C	R407	4B	R441	3B	RT422	4C
						U440	3C

@



A5
VERTICAL OUTPUT
CIRCUIT BOARD

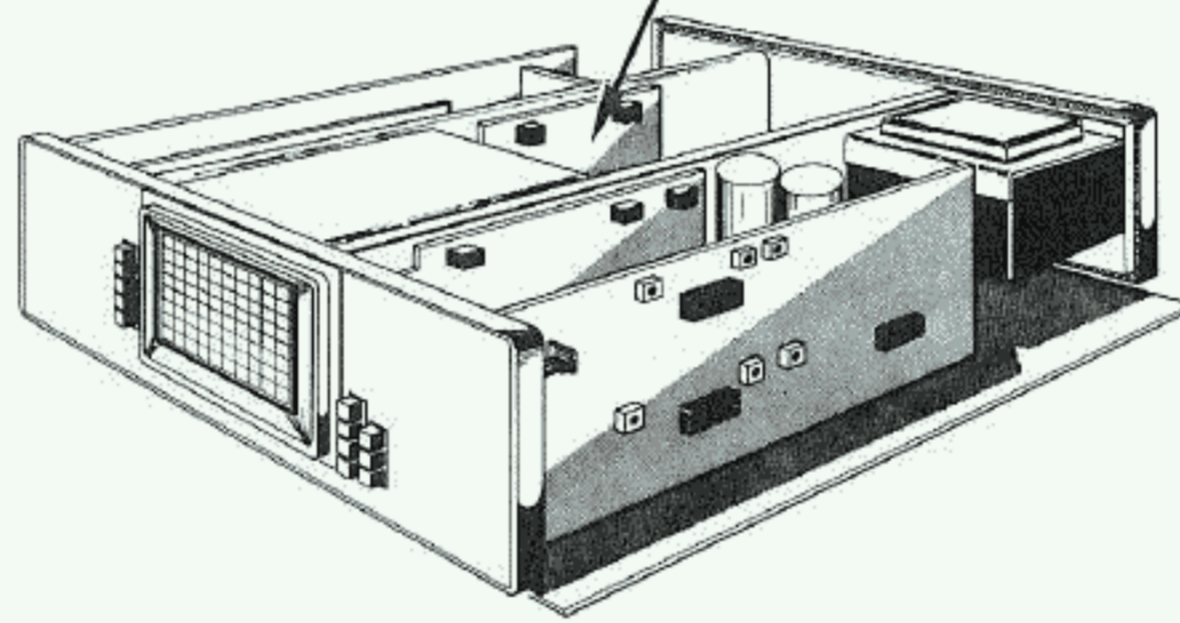

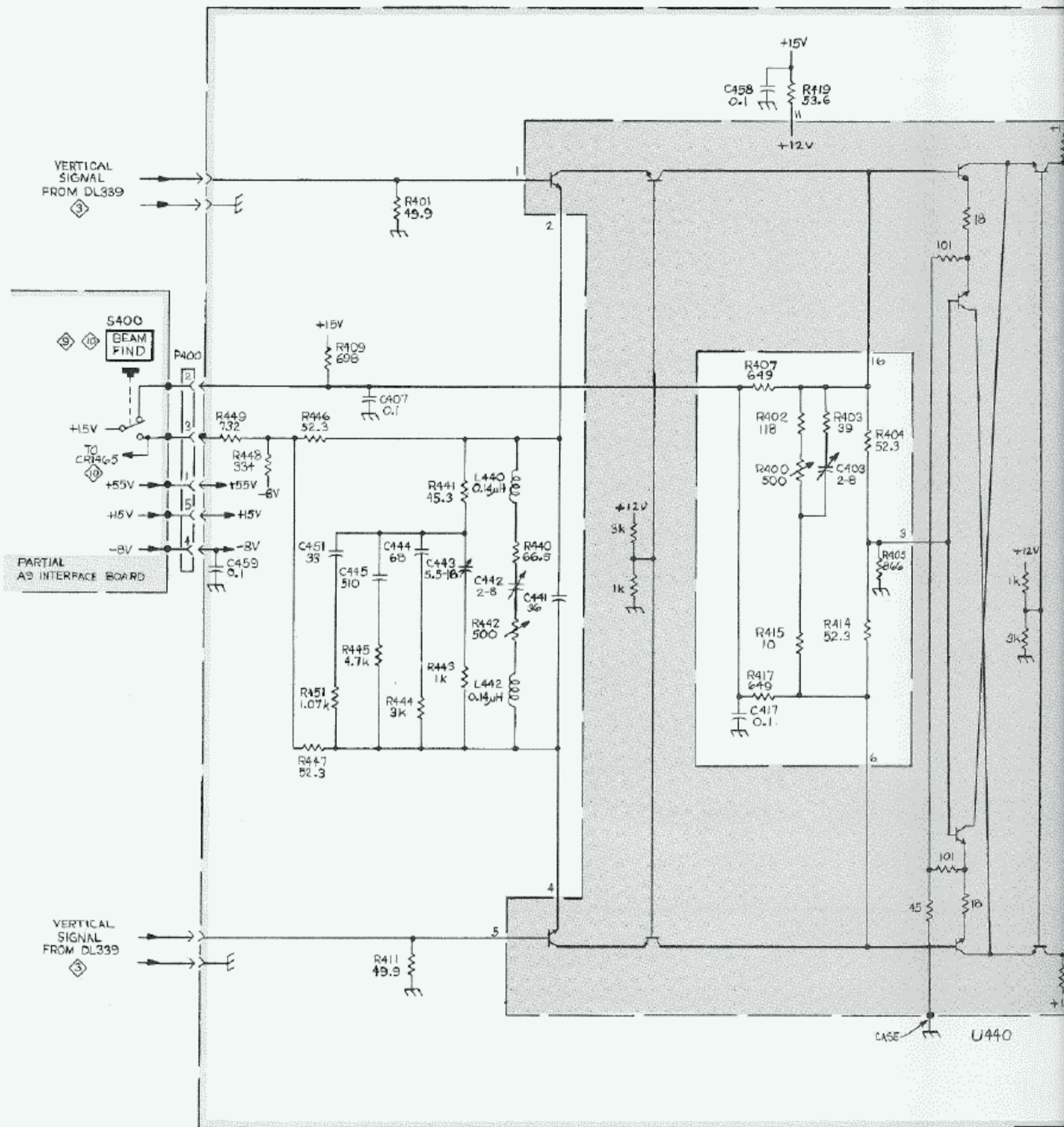

+

@

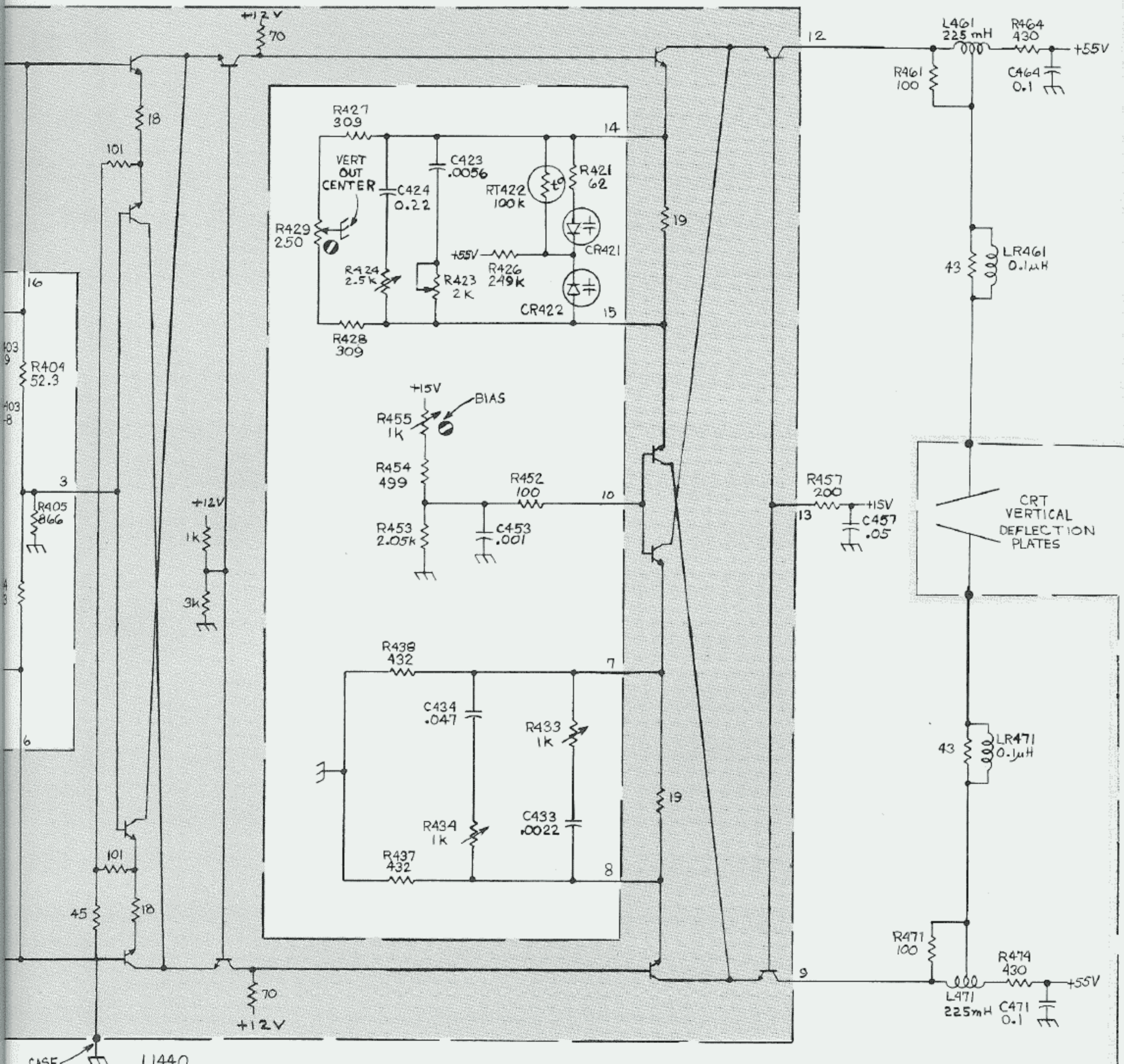

VERTICAL OUTPUT AMP (IC VERSION)

4 b

VERTICAL OUTPUT AMPLIFIER 4_b
 SN B250000 and up
 670-2238- (IC VERSION)

@

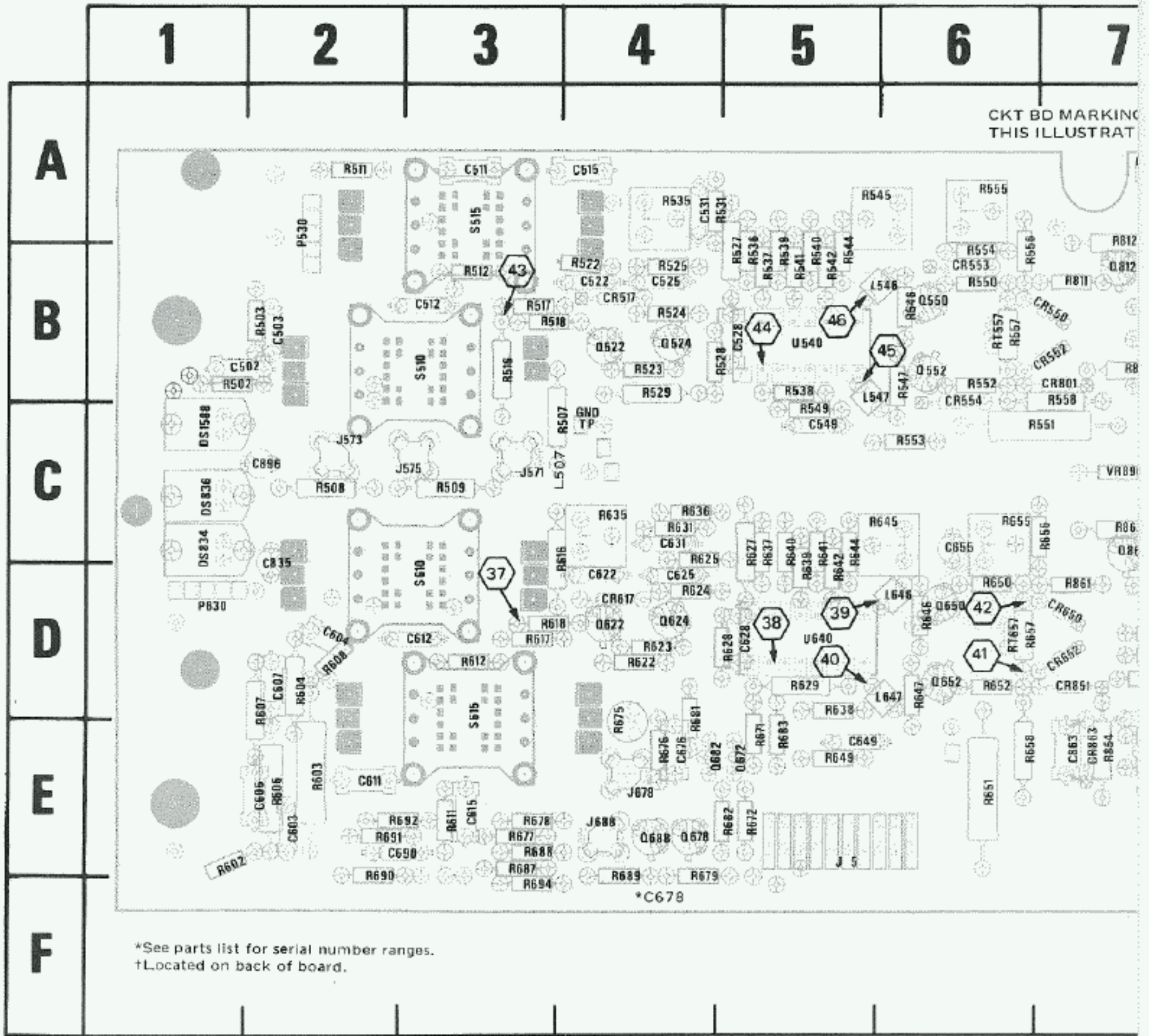
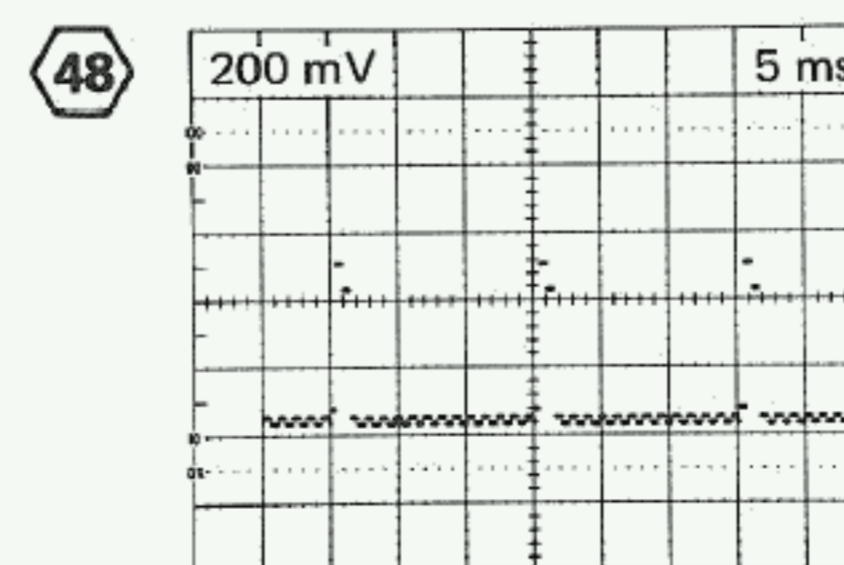
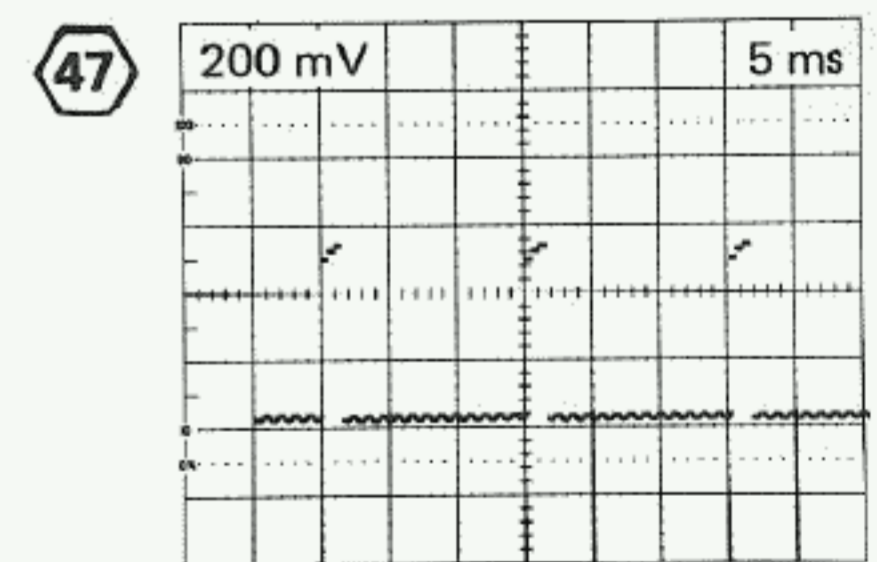
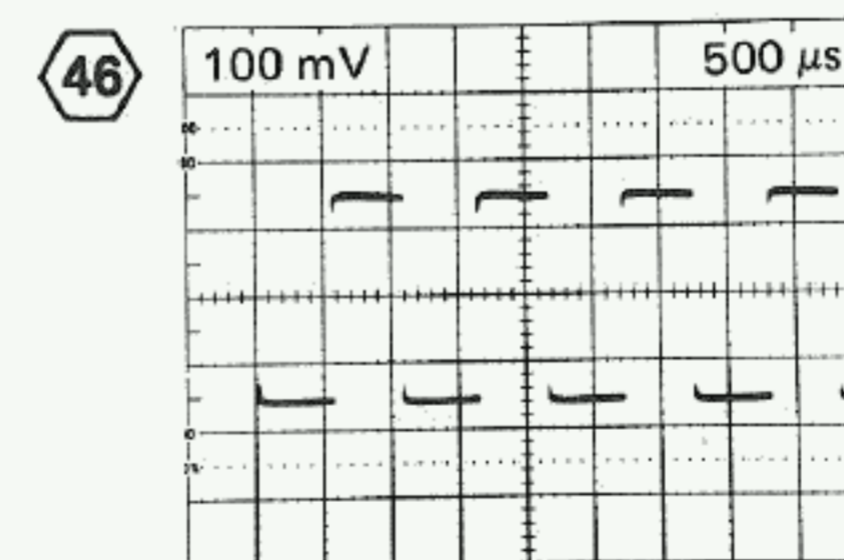
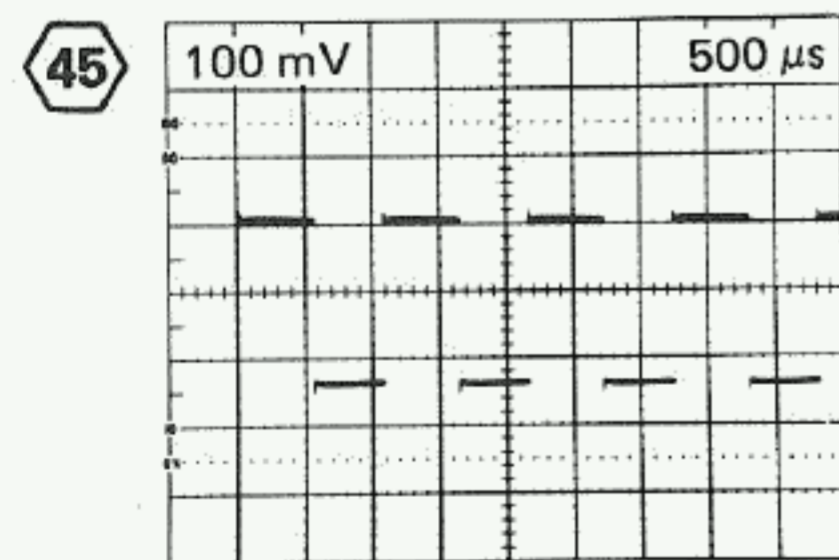
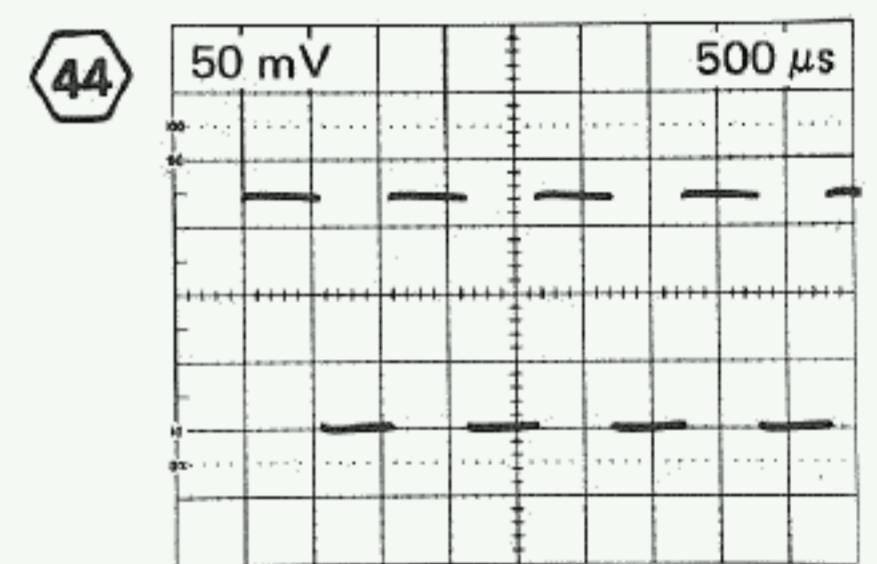
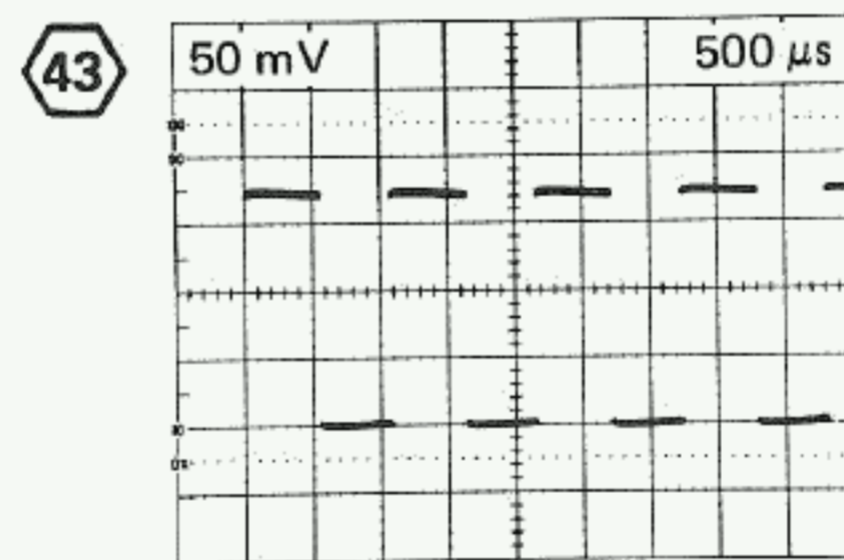
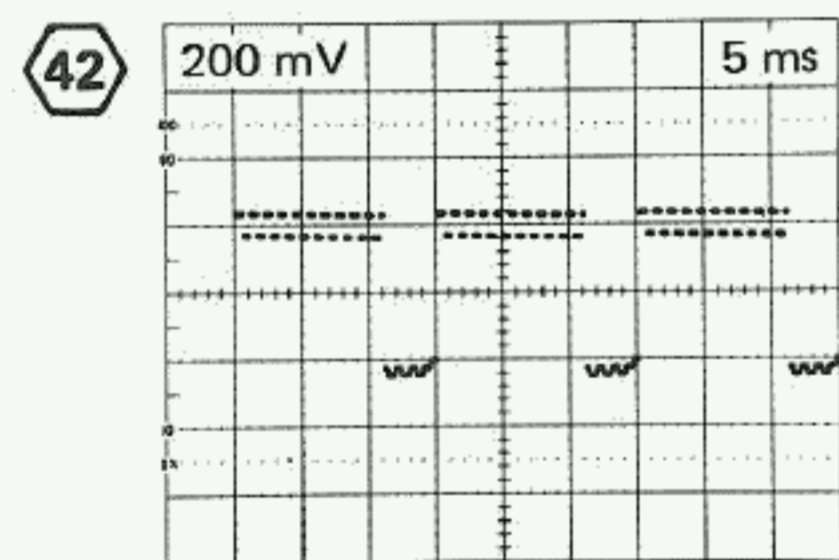
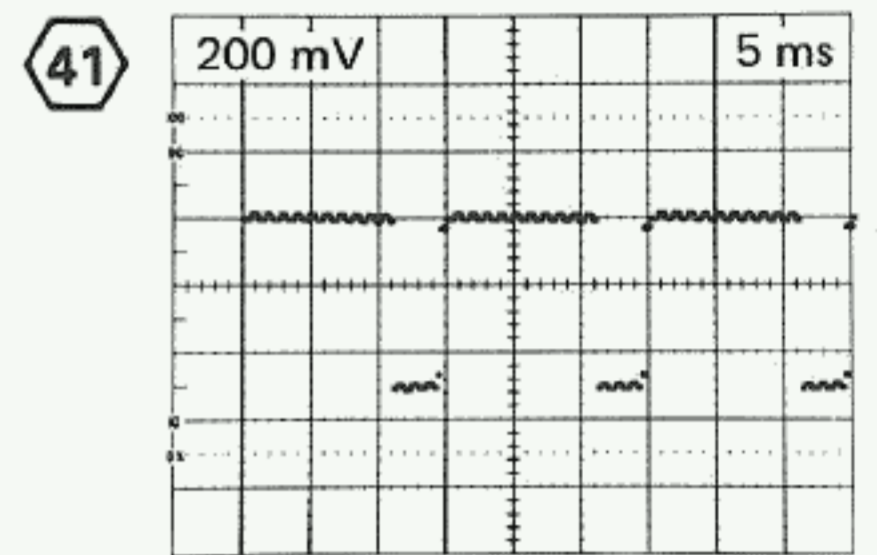
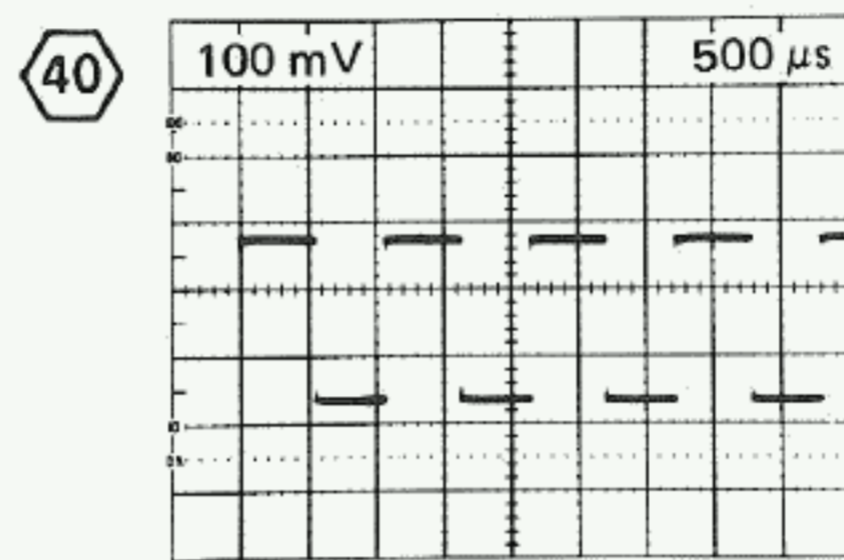
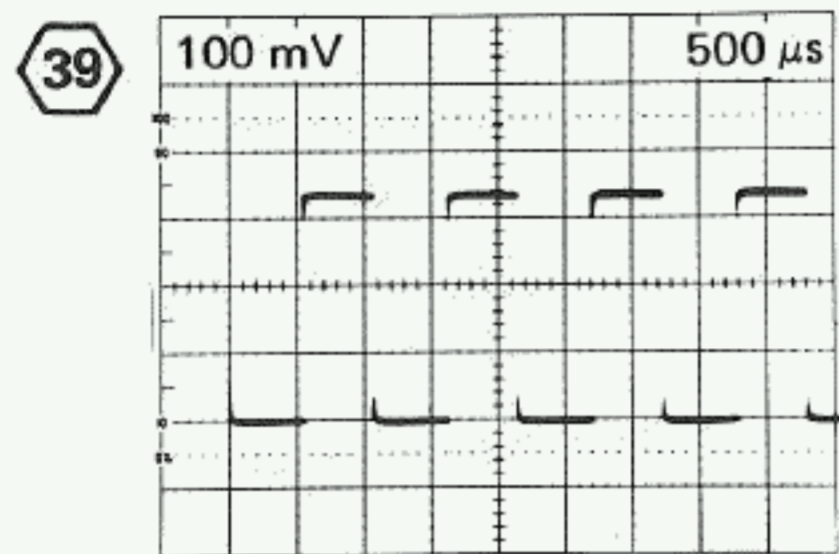
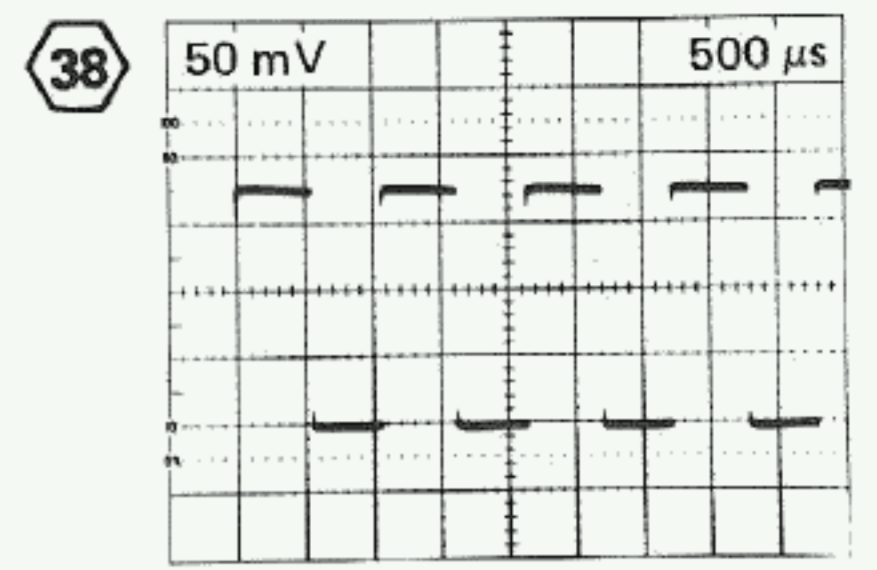
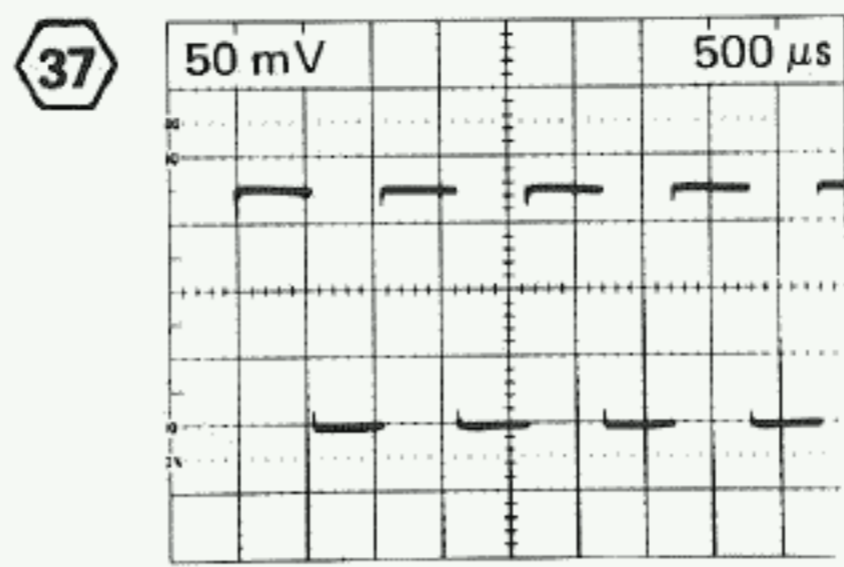
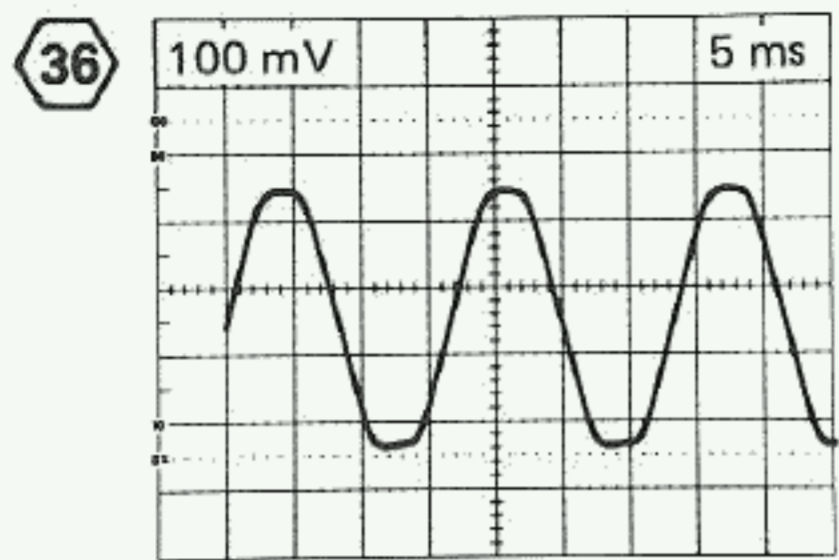

Fig. 8-9. A8—Trigger Generator and Sweep



ASSEMBLY A8

GRID LOC	CKT NO	GRID LOC	CKT NO	GRID LOC	CKT NO	GRID LOC	CKT NO	GRID LOC
9B	Q678	4E	R565	7C	R815	7B	R1584	10E
7B	Q682	4E	R602	1E	R817	7B	R1585	10E
9B	Q688	4E	R603	2E	R818	7B	R1597	10E
10B	Q804	8B	R604	2D	R822	9B	R1587	10E
10B	Q812	7B	R606	2E	R823	8C	R1589	10E
9C	Q814	7B	R607	2D	R824	8C		
7D	Q822	9B	R608	2D	R827	9C	RT557	6B
8D	Q824	9B	R609	8E	R828	9B	RT657	6D
8C	Q828	9B	R611	3E	R829	10B		
7E	Q854	8D	R612	3D	R831	9B	S510	3B
9C	Q862	7C	R616	4C	R834	8C	S515	3A
9A	Q864	7C	R617	3D	R836	8C	S610	3D
9A	Q1042	8A	R618	3D	R838	9D	S615	3D
10B	Q1044	9A	R622	4D	R853	7D		
10B	Q1052	9B	R623	4D	R854	7E	U540	5B
10B	Q1054	9A	R624	4D	R855	7D	U640	5D
11A	Q1304	10B	R625	4C	R856	7E	U870	9D
11A	Q1306	10B	R627	5C	R857	8D		
10D	Q1314	10A	R628	5D	R858	8D	VR875	9C
10D	Q1324	11A	R629	5D	R859	7E	VR896	7C
12A	Q1326	11B	R631	4C	R861	7D		
12A	Q1334	11B	R635	4C	R862	7C		
12A	Q1582	10E	R636	4C	R863	7E		
10D	Q1588	11E	R637	5C	R864	7D		
10D			R638	5D	R865	7D		
10D			R639	5C	R866	7D		
10D	R502	1B	R640	5C	R871	9C		
	R503	2B	R641	5C	R872	9C		
1C	R507	4C	R642	5C	R877	9C		
1C	R508	2C	R644	5C	R879	9C		
1C	R509	3C	R645	5C	R1041	8A		
1C	R511	2A	R646	6D	R1044	9B		
	R512	3B	R647	6D	R1045	8A		
9E	R516	3B	R649	5E	R1046	8B		
3C	R517	3B	R650	6D	R1047	8A		
2C	R518	3B	R651	6E	R1048	8A		
3C	R522	4B	R652	6D	R1049	8A		
4E	R523	4B	R655	6C	R1052	8B		
4E	R524	4B	R656	7C	R1053	8B		
9A	R525	4B	R657	6D	R1054	8B		
10A	R527	5B	R658	6E	R1057	8A		
10A	R528	4B	R671	5E	R1301	10B		
	R529	4B	R672	5E	R1302	10B		
4C	R531	4A	R675	4D	R1303	10B		
5B	R535	4A	R676	4E	R1304	11A		
5B	R536	5B	R677	3E	R1306	10C		
6D	R537	5B	R678	3E	R1307	10B		
6D	R538	5B	R679	4F	R1308	10B		
10C	R539	5B	R681	4D	R1314	11A		
12C	R540	5B	R682	5E	R1315	11B		
12C	R541	5B	R683	5E	R1317	10A		
12C	R542	5B	R687	3E	R1321	12B		
	R544	5B	R688	3E	R1322	11B		
2A	R545	5A	R689	4F	R1323	11B		
1D	R546	6B	R690	2E	R1324	12A		
8A	R547	6B	R691	2E	R1326	10C		
	R549	5C	R692	2E	R1327	11B		
4B	R550	6B	R694	3F	R1328	11B		
4B	R551	7C	R803	7B	R1334	12A		
6B	R552	6B	R804	7B	R1335	11A		
7B	R553	6C	R805	7B	R1337	10A		
4D	R554	6B	R807	8B	R1339	12B		
4D	R555	6A	R808	8B	R1345	10C		
6D	R556	6B	R809	8B	R1348	11B		
6D	R557	6B	R811	7B	R1349	11B		
5E	R558	7B	R812	7A	R1581	10E		
			R814	7B				



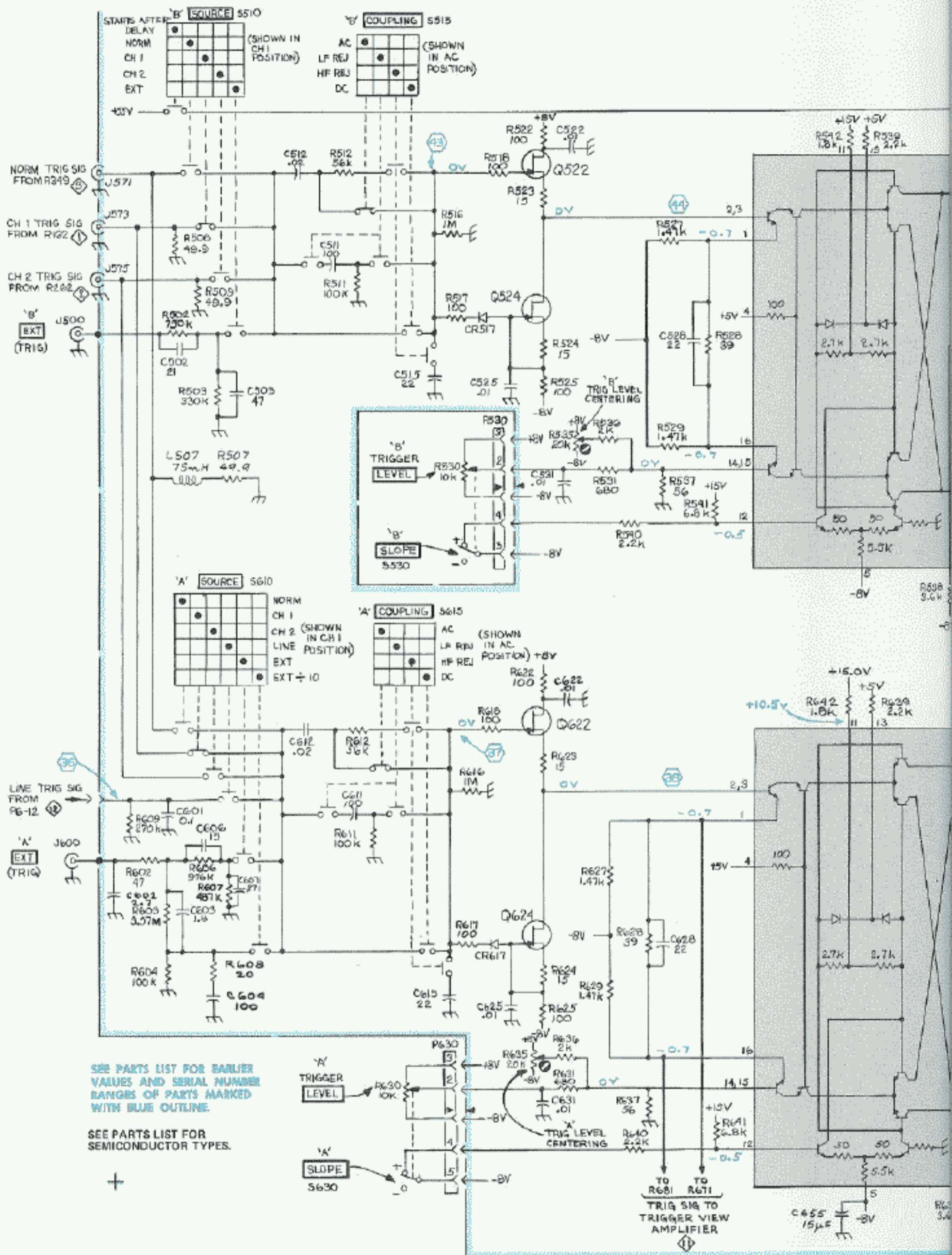

SEE PARTS LIST FOR EARLIER VALUES AND SERIAL NUMBER RANGES OF PARTS MARKED WITH BLUE OUTLINE.

SEE PARTS LIST FOR SEMICONDUCTOR TYPES.

+

TO R681 TO R671 TRIG SIG TO TRIGGER VIEW AMPLIFIER

CKT NO	GRID LOC	CKT NO	GRID LOC	CKT NO	GRID LOC	CKT NO	GRID LOC	CKT NO	GRID LOC
CR1534	4G	Q1404	4D	R1086	8I	R1284	6C	R1519	5G
CR1535	1F	Q1408	5E	R1089	8H	R1286	6D	R1521	4G
CR1536	2F	Q1413	1B	R1091	9H	R1288	7D	R1523	2F
CR1541	3H	Q1414	1C	R1092	9H	R1289	6F	R1524	4G
CR1549	1G	Q1416	2A	R1093	9H	R1400	5F	R1525	2F
CR1551	4I	Q1418 ³		R1095	9H	R1401	4E	R1527	2F
CR1556	3F	Q1466	3E	R1097	8G	R1402	5E	R1528	4F
CR1559	4F	Q1472	3E	R1098	8G	R1403	5E	R1532	1E
CR1561	2G	Q1474	2D	R1201	8F	R1404	4E	R1533	2E
CR1564	1C	Q1478	2D	R1202	8F	R1406	5E	R1534	1F
CR1569	3H	Q1516	4H	R1206	10F	R1407	5D	R1537	2F
		Q1518	5G	R1207	10F	R1408	4F	R1538	2F
DS1425	3C	Q1532	1E	R1208	9F	R1409	2A	R1539	2G
DS1426	3C	Q1534	1E	R1209	9F	R1411	1B	R1543	2G
		Q1536	2E	R1211	10F	R1412	1B	R1544	2G
F1419	2H	Q1544	1G	R1212	10F	R1413	1B	R1546	1G
		Q1546	1F	R1215	10F	R1414	1B	R1547	2G
J1	10H	Q1548	1G	R1216	10F	R1416	1B	R1549	1G
J2	7H	Q1556	3F	R1217	9F	R1420	2C	R1553	1E
J3	6H	Q1558	3F	R1218	9F	R1421	4B	R1554	1E
		Q1564	1D	R1219	8F	R1422	4C	R1556	3F
L1006	11I	Q1566	1D	R1220	7F	R1423	4C	R1557	2F
L1419	1C	Q1568	1D	R1221	8F	R1427	1B	R1559	3F
L1596	9C	Q1570	11C	R1222	8F	R1428	2B	R1563	1E
		Q1590	10C	R1223	8F	R1430	5C	R1564	2E
P5	9I	Q1594	9C	R1224	8F	R1431	4D	R1565	2E
P6	6I	Q1598	9C	R1225	9E	R1434	7B	R1566	1D
P300	7B			R1226	9E	R1440	11E	R1567	1D
P1155	12F	R39	8B	R1228	9E	R1442	7C	R1569	1D
P1200	11G	R1001	10H	R1229	9E	R1445	10D	R1570	11D
P1400	2B	R1002	9H	R1231	8E	R1446	7C	R1571	11D
P1440	11E	R1003	10H	R1232	8F	R1447	6A	R1591	10C
P1445	5A	R1004	11H	R1233	8E	R1448	6A	R1592	10D
P1446	8C	R1006	10H	R1234	8E	R1449	6A	R1593	10C
P1452	4E	R1007	11H	R1235	7G	R1451	4E	R1594	10D
P1570	11B	R1011	10I	R1236	8D	R1452	4E	R1595	9C
P1590	10C	R1012	10I	R1237	9E	R1453	4E	R1597	10C
		R1013	10I	R1238	9E	R1460	7B	R1598	10C
Q1002	11I	R1016	10I	R1239	9E	R1461	6G	R1599	10C
Q1012	10I	R1017	10H	R1241	8D	R1462	4D	RT1230	8F
Q1014	11I	R1021	11H	R1242	8D	R1463	6C	S400	9A
Q1024	11H	R1022	11H	R1244	8D	R1464	4F	S1239	9E
Q1030	12H	R1024	11H	R1246	8C	R1466	4E	†T1420	2A
Q1036	12I	R1026	11I	R1247	8D	R1467	4E	TP1486	3D
Q1038	9G	R1029	11H	R1248	8D	R1468	3E	TP1518	6F
Q1062	8I	R1031	12H	R1249	8C	R1469	3D	TP1536	5F
Q1063	6H	R1032	12H	R1253	8E	R1470	3E	TP1548	5F
Q1072	7I	R1033	12H	R1254	6F	R1471	4E	TP1558	5F
Q1074	7I	R1035	12H	R1255	8E	R1472	3E	TP1568	5F
Q1084	8H	R1037	10G	R1260	7E	R1473	3E	TP1590	10C
Q1090	8H	R1038	10G	R1261	6E	R1474	3E	TP1594	9D
Q1096	9I	R1039	10G	R1262	6F	R1475	2D		
Q1098	8G	R1061	7H	R1263	6F	R1476	2D	†U1432	5B
Q1214	9F	R1062	6H	R1264	6F	R1477	3E	U1524	2G
Q1218	9F	R1063	7H	R1266	6E	R1478	3D	U1554	1E
Q1224	8F	R1064	8H	R1268	7F	R1480	2D		
Q1226	8E	R1065	8I	R1269	6F	R1481	2C	VR1039	9G
Q1234	8F	R1066	7H	R1273	8D	R1482	3C	VR1099	7G
Q1236	8D	R1071	6I	R1274	8D	R1484	2C	VR1155	12F
Q1244	8D	R1072	6I	R1275	8D	R1485	3D	VR1289	6F
Q1254	7E	R1073	7I	R1280	6D	R1486	4C	VR1428	2B
Q1262	6E	R1076	7I	R1281	7D	R1488	2C	VR1484	2C
Q1266	6E	R1077	7H	R1282	6C	R1510	5I	VR1515	4G
Q1274	7D	R1081	8H	R1283	6D	R1511	4I	VR1522	3G
Q1282	6D	R1082	8H			R1516	4H	VR1525	1F
Q1286	6D	R1084	8H			R1517	6G	VR1526	2G
						R1518	5H	VR1533	3F
								VR1570	11C

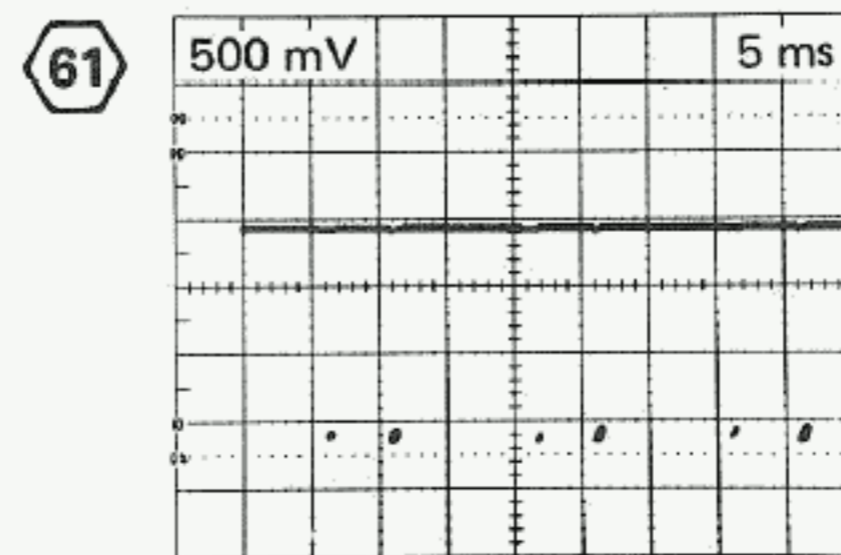
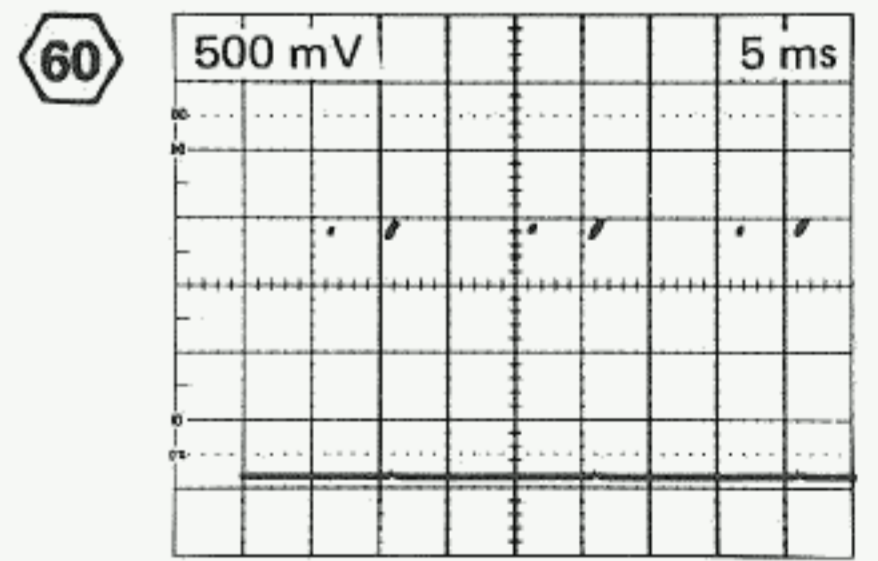
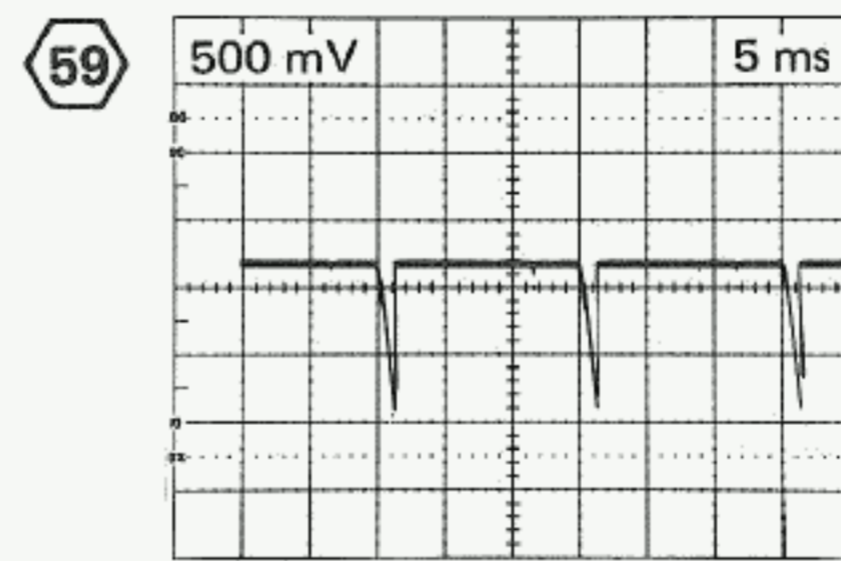
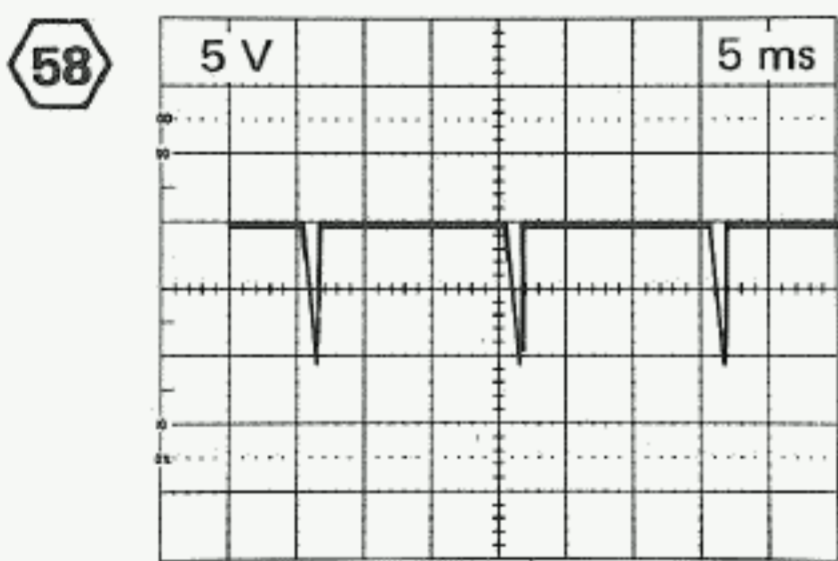
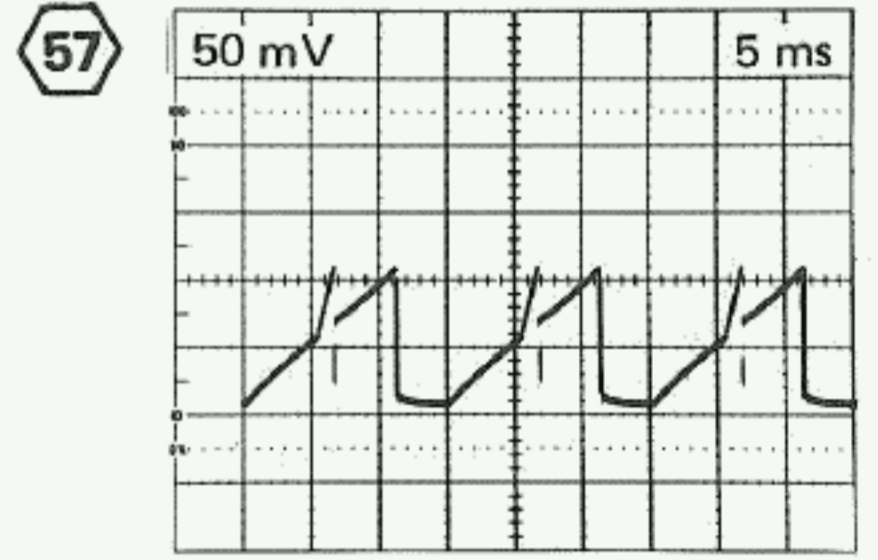
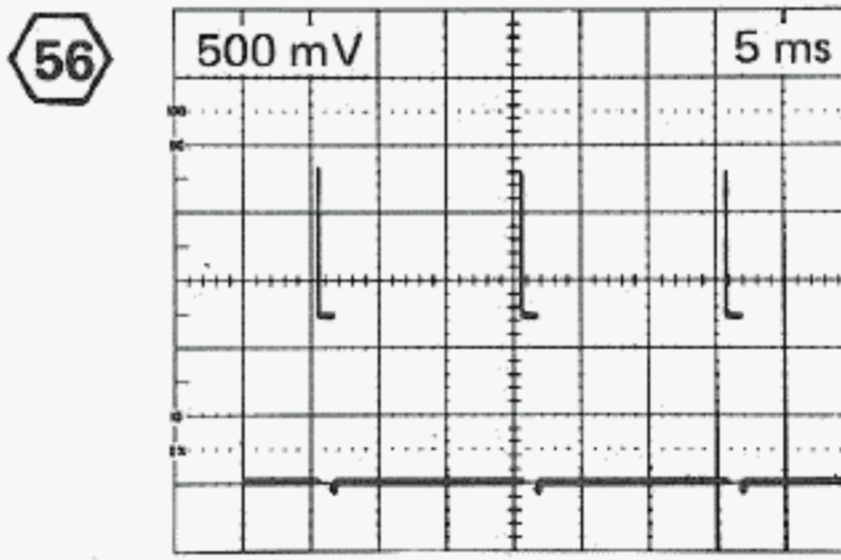
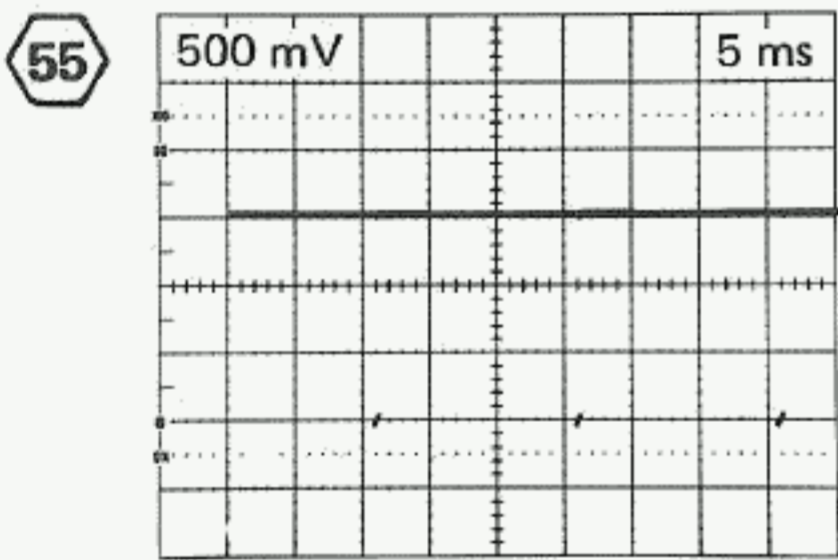
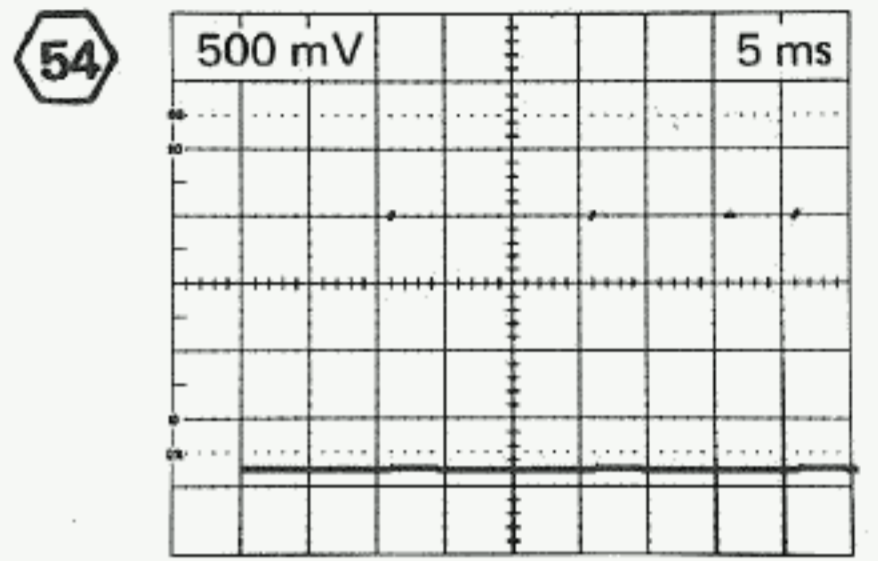
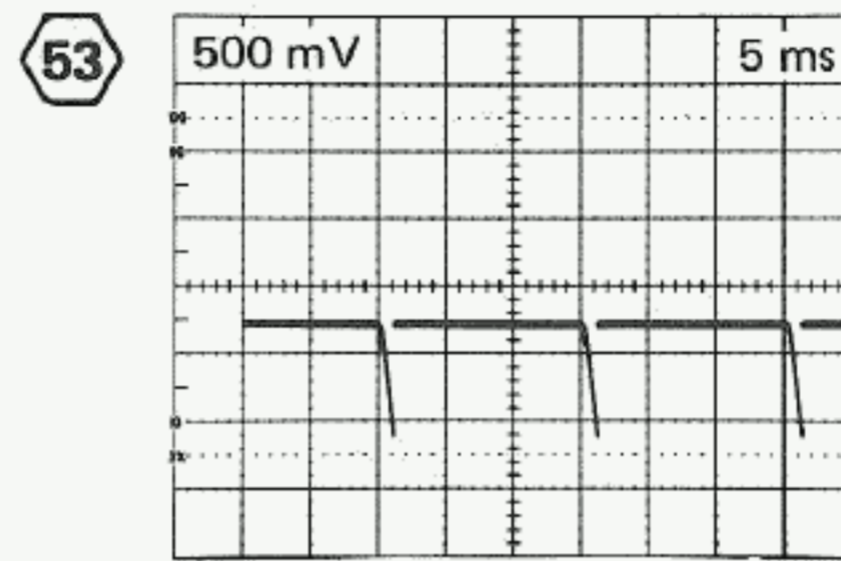
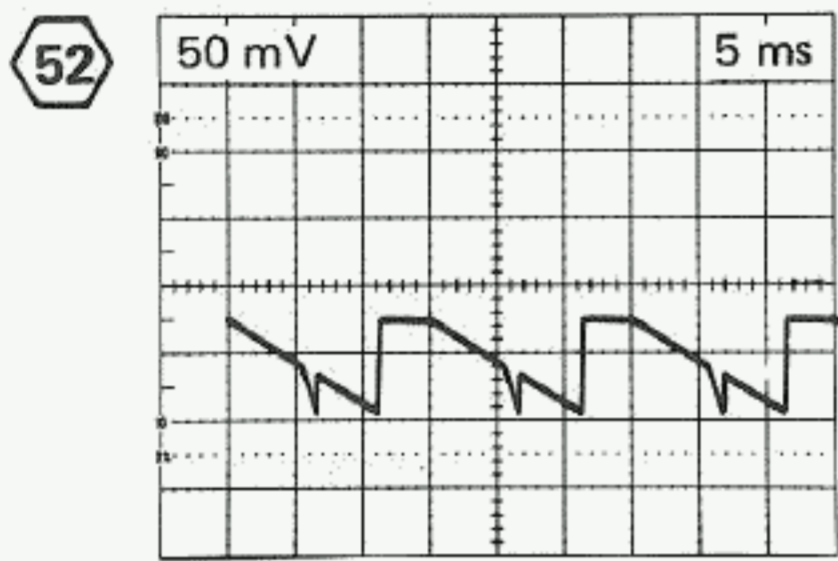
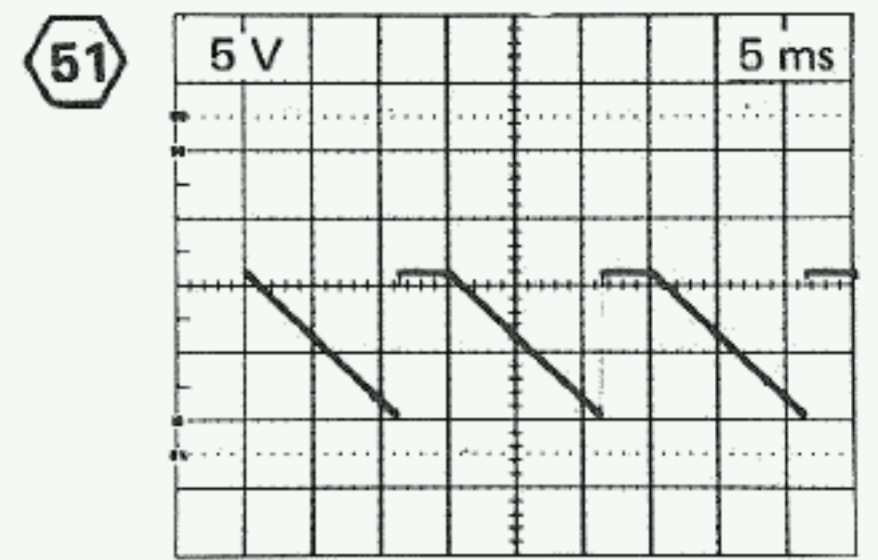
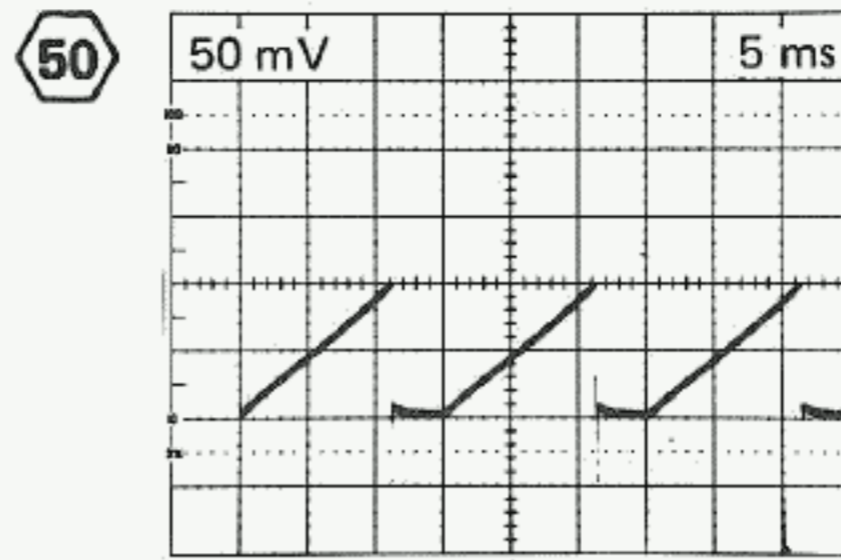
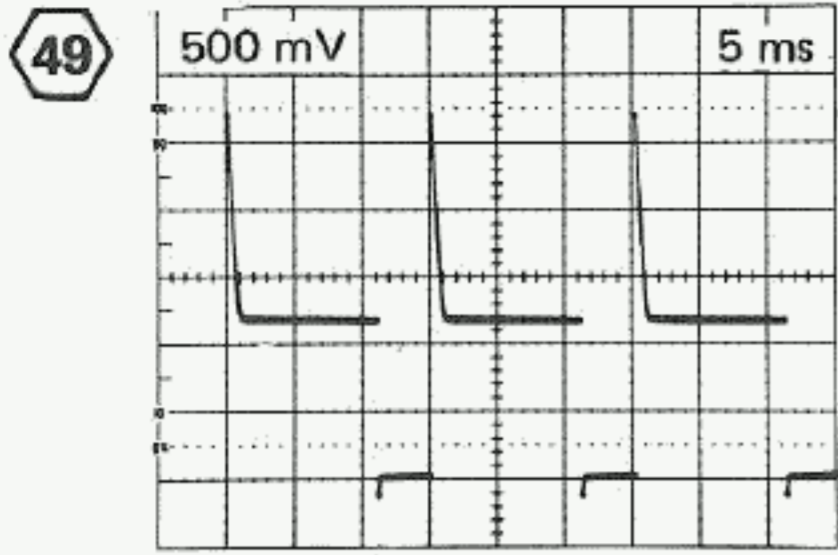

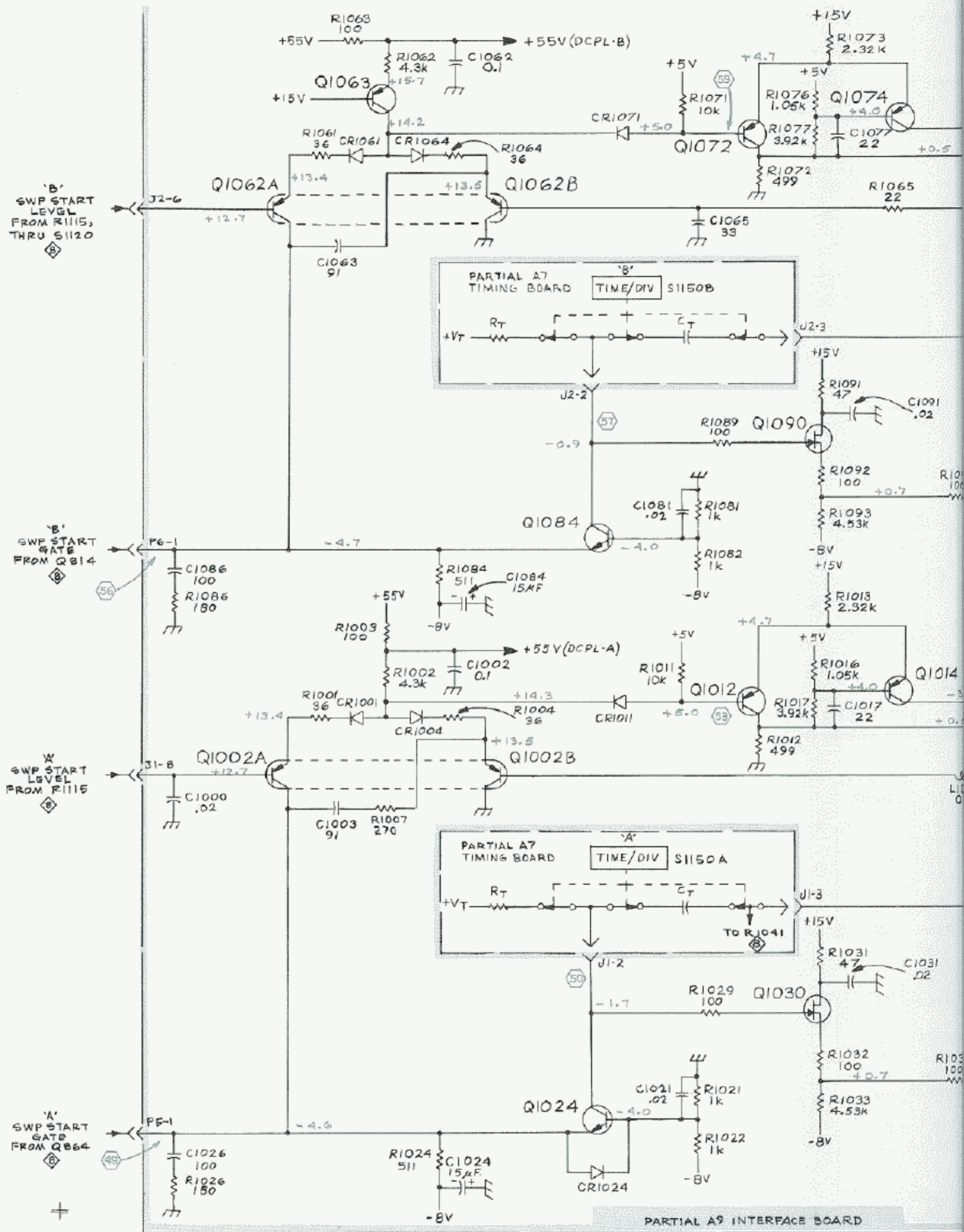

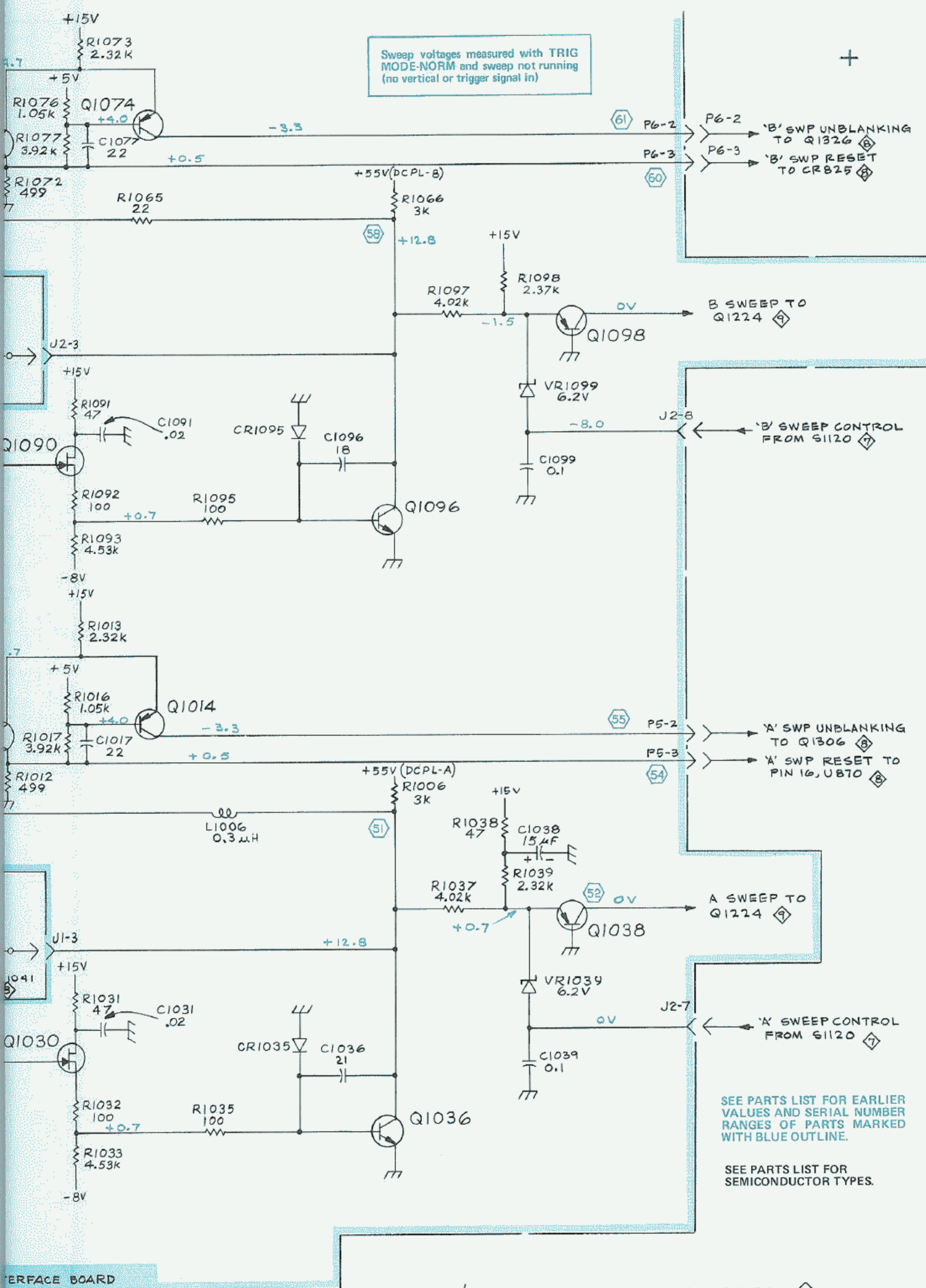

Sweep voltages measured with TRIG MODE-NORM and sweep not running (no vertical or trigger signal in)

P6-2 'B' SWP UNBLANKING TO Q1326
 P6-3 'B' SWP RESET TO CR825

B SWEEP TO Q1224

J2-8 'B' SWEEP CONTROL FROM S1120

P5-2 'A' SWP UNBLANKING TO Q1306
 P5-3 'A' SWP RESET TO PIN 16, U870

A SWEEP TO Q1224

J2-7 'A' SWEEP CONTROL FROM S1120

SEE PARTS LIST FOR EARLIER VALUES AND SERIAL NUMBER RANGES OF PARTS MARKED WITH BLUE OUTLINE.

SEE PARTS LIST FOR SEMICONDUCTOR TYPES.

INTERFACE BOARD

A JUNE, 1975

A & B SWEEP GENERATORS

SN B250000 and up

MEB 874

ASSEMBLY A7

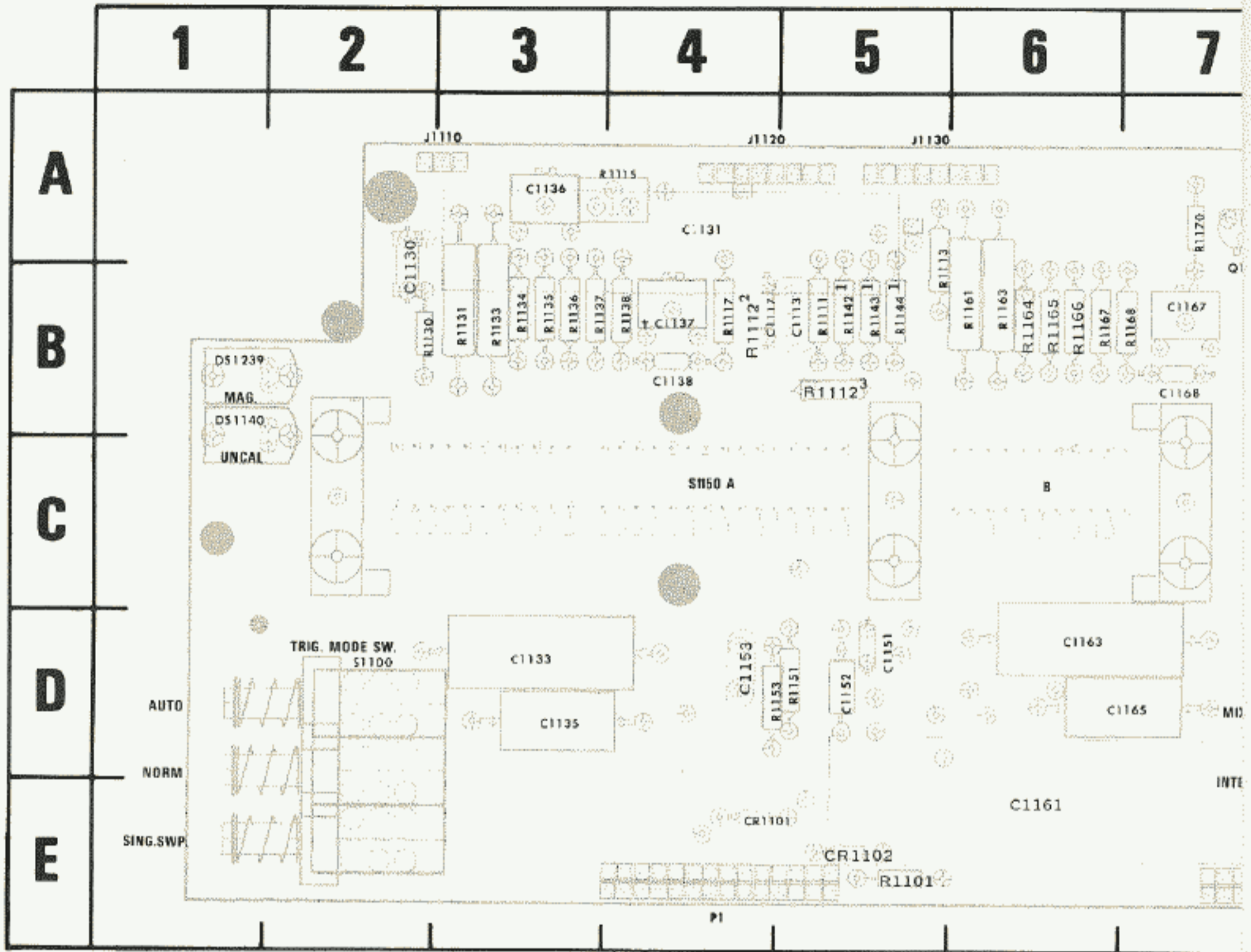

*See parts list for serial number ranges.
 †Located on back of board.
 1 On Instruments with a DM43 or DM40 only.
 2 Location for standard 465
 3 Location for 465 DM 43/DM40

Fig. 8-11. A7—Timing circuit board.

CKT NO	GRID LOC	CKT NO	GRID LOC	CKT NO	GRID LOC	CKT NO	GRID LOC
C1113	5B	CR1102	5E	R1112 ²	4B	R1153	4D
C1117	4B	DS1140	1B	R1113	5A	R1161	6B
C1130	2A	DS1239	1B	R1115	4A	R1163	6B
C1131	4A	J1110	2A	R1117	4B	R1164	6B
C1133	3D	J1120	4A	R1130	2B	R1165	6B
C1135	3D	J1130	5A	R1131	3B	R1166	6B
C1136	3A	P1	4E	R1133	3B	R1167	6B
†C1137	4B	P2	7E	R1134	3B	R1168	7B
C1138	4B	P3	9E	R1135	3B	R1170	7A
C1151	5D	Q1140	9A	R1136	3B	R1175	7A
C1152	5D	Q1170	7A	R1137	3B	S1100	2D
C1153	4D	R1101	5E	R1138	4B	S1120	8C
C1161	6E	R1111	5B	R1140	8C	S1140	9C
C1163	6D	R1112	5B	R1141	9B	S1150A	4C
C1165	7D	R1112 ³	5B	R1142	5B	VR1145	8B
C1167	7B	R1112 ³	5B	R1143	5B	VR1146	8B
C1168	7B	R1101	5E	R1144	5B		
		R1111	5B	R1145	8A		
		R1112	5B	R1146	8B		
		R1112 ³	5B	R1151	5D		



8

9

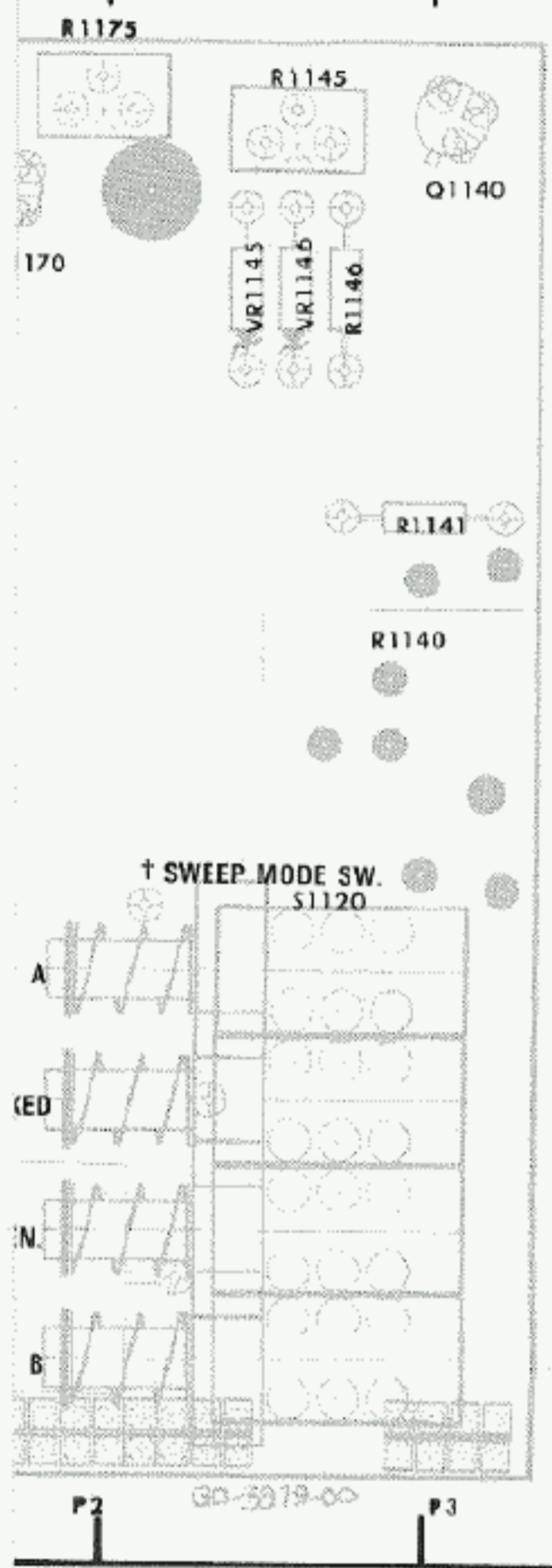

A7
TIMING
CIRCUIT BOARD

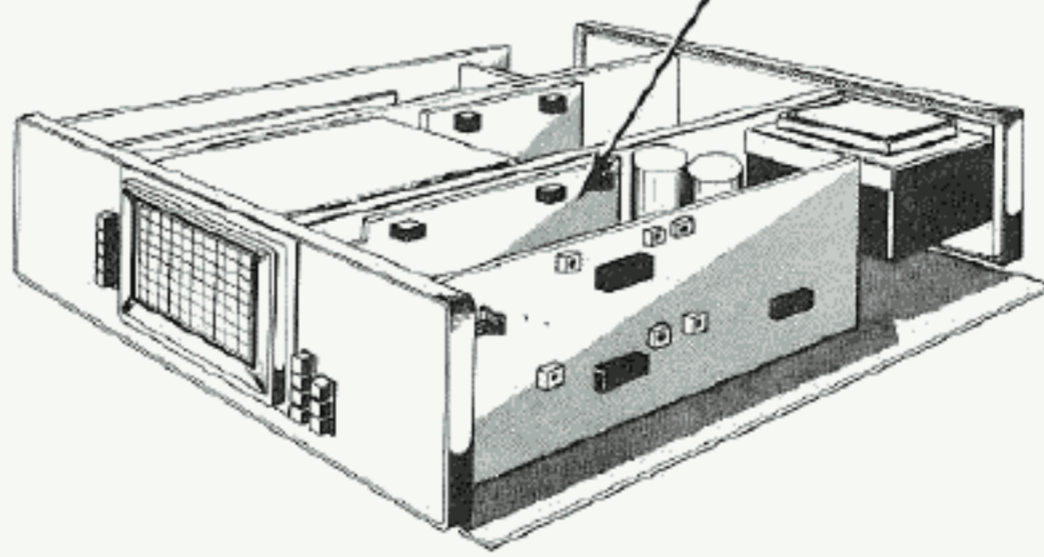

PARTIAL A7 TIMING BOARD

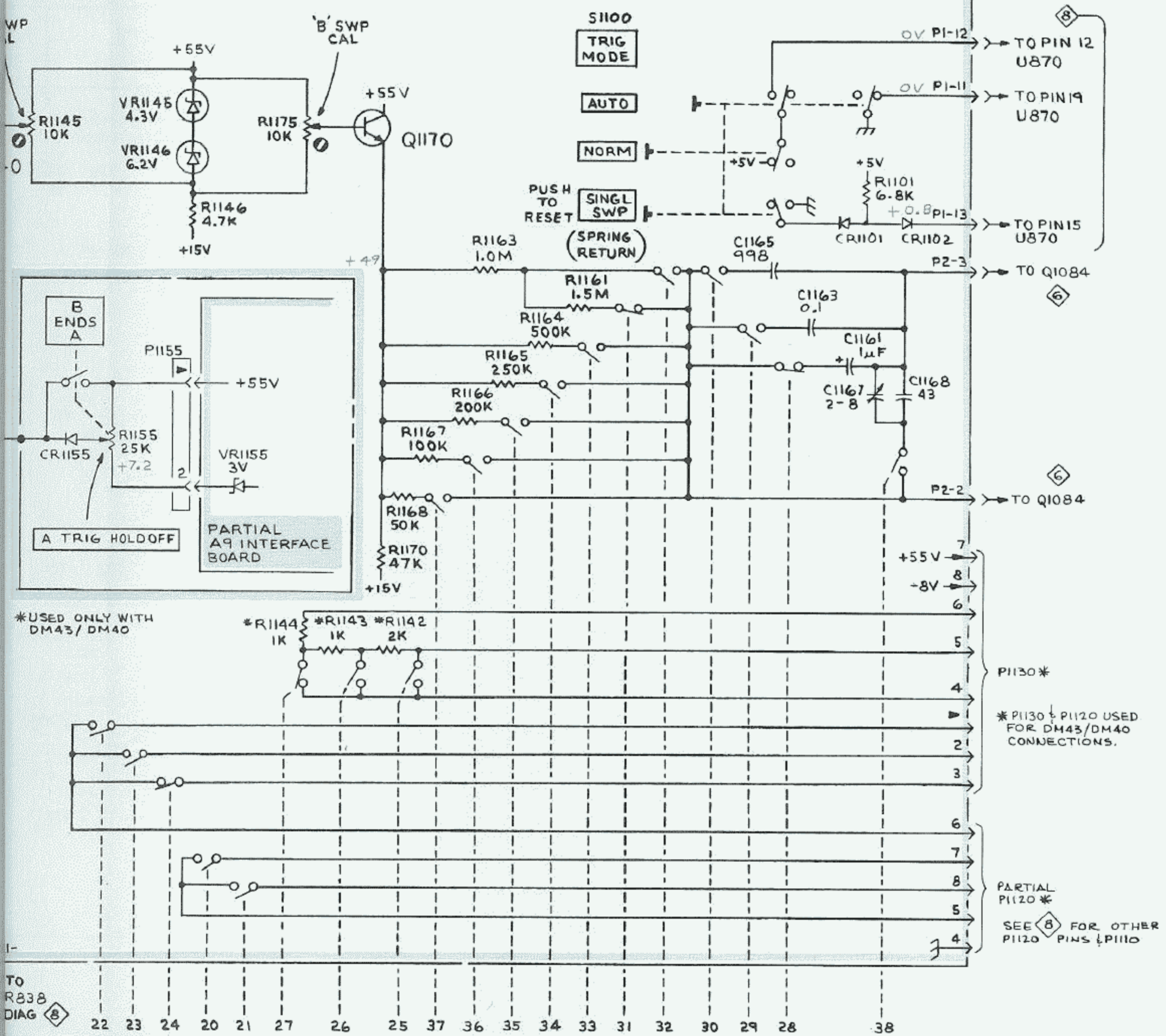

*USED ONLY WITH DM43/DM40

*R1144 1K

*R1143 1K

*R1142 2K

PI130*

*PI130 & PI120 USED FOR DM43/DM40 CONNECTIONS.

PARTIAL PI120*

SEE 8 FOR OTHER PI120 PINS & PI110

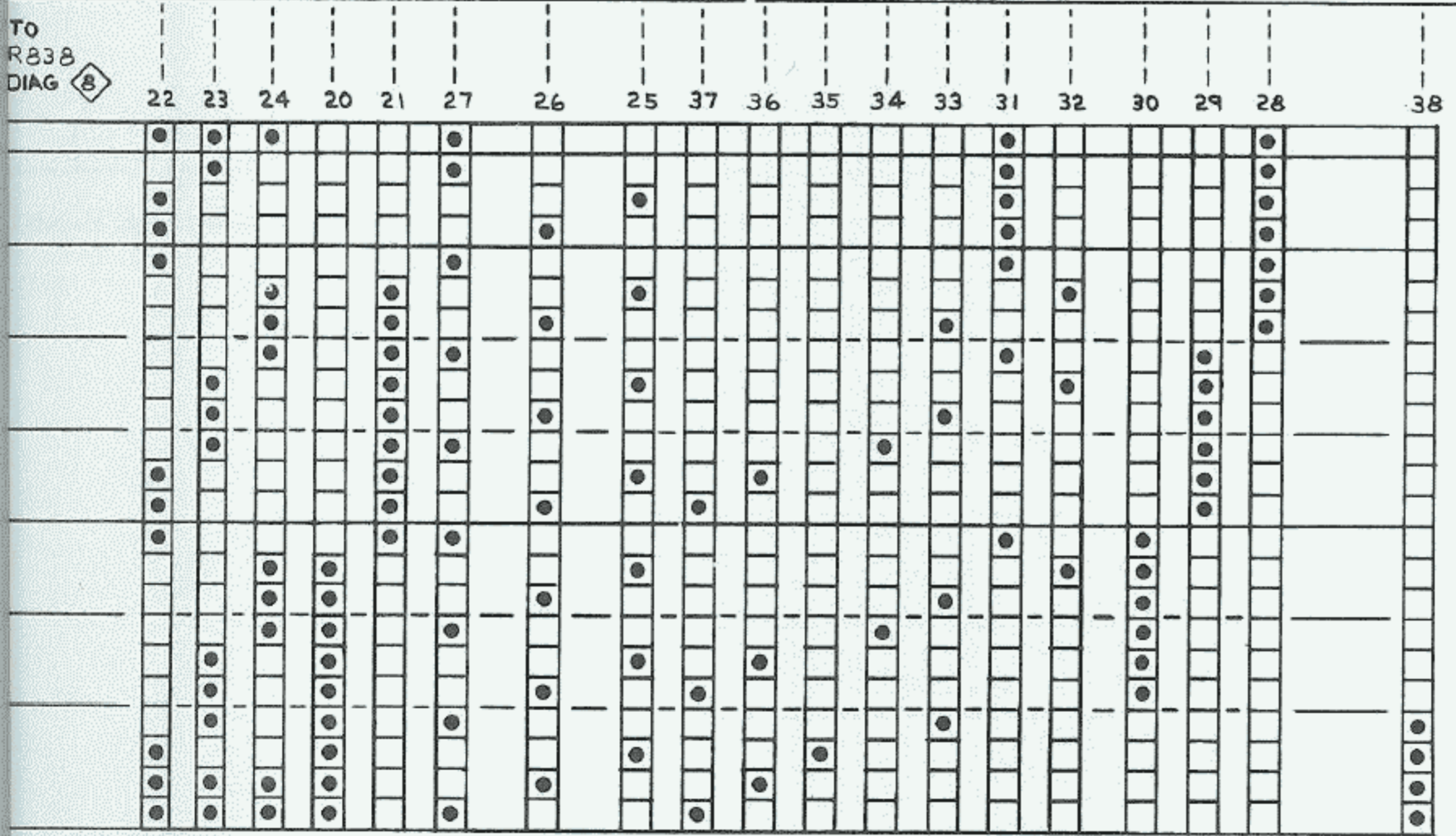

'B' AND ME

@

A & B TIMING SWITCH 7

SN B250000 and up

A & B TIMING SWITCH

7

8

9

10

11

12

NOTES FOR Q822 Q824 MAY BE REVERSED
IF POSITION IS CORRECT

CKT BD MARKINGS FOR Q1324 Q1334 MAY BE REVERSED
THIS ILLUSTRATION IS CORRECT

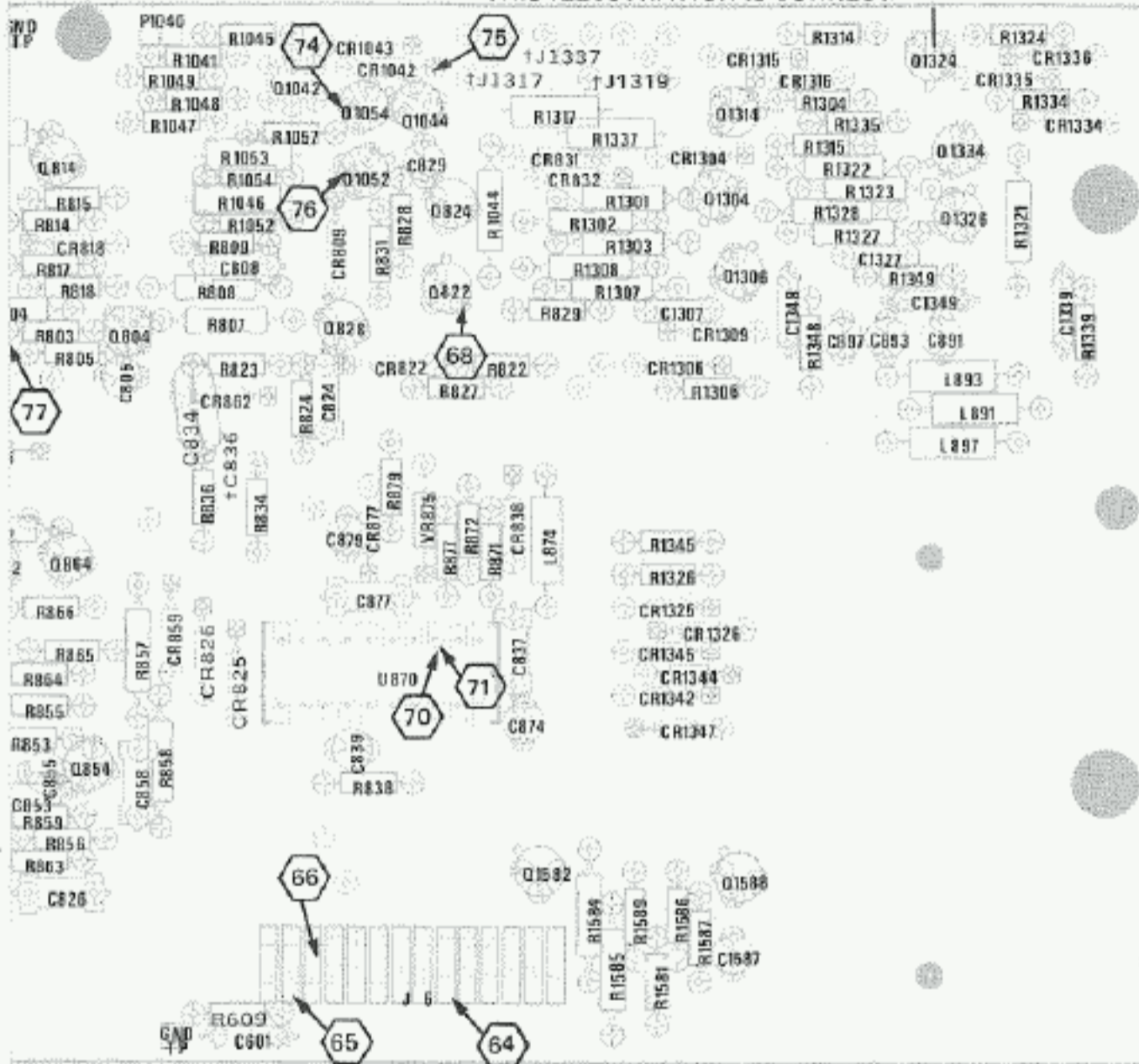

† LOCATED ON BACK OF BOARD

J1317 C836
J1319 C1044
J1339

logic circuit board.

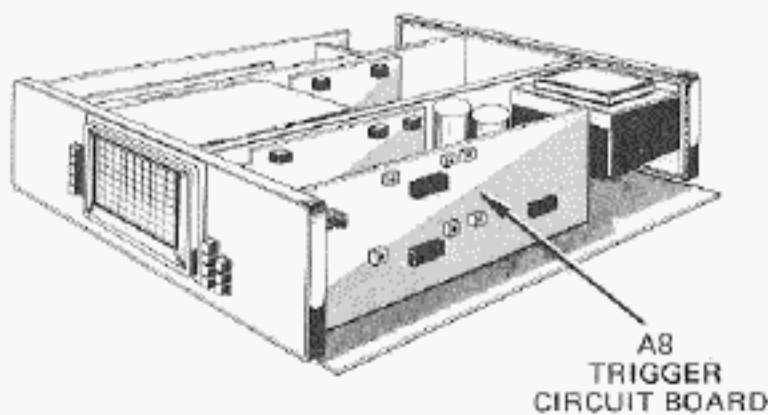

A8
TRIGGER
CIRCUIT BOARD

CKT NO	GRID LOC	CKT NO	GRID LOC	CKT NO	GRID LOC
C502	1B	CR809	9B	Q678	4E
C503	2B	CR818	7B	Q682	4E
C511	3A	CR822	9B	Q688	4E
C512	3B	CR831	10B	Q804	8B
C515	4A	CR832	10B	Q812	7B
C522	4B	CR838	9C	Q814	7B
C525	4B	CR851	7D	Q822	9B
C528	5B	CR859	8D	Q824	9B
C531	4A	CR862	8C	Q828	9B
C549	5C	CR863	7E	Q854	8D
C601	8F	CR877	9C	Q862	7C
C603	2E	CR1042	9A	Q864	7C
C604	2D	CR1043	9A	Q1042	8A
C606	2E	CR1304	10B	Q1044	9A
C607	2D	CR1306	10B	Q1052	9B
C611	2E	CR1309	10B	Q1054	9A
C612	3D	CR1315	11A	Q1304	10B
C615	3E	CR1316	11A	Q1306	10B
C622	4D	CR1325	10D	Q1314	10A
C625	4D	CR1326	10D	Q1324	11A
C628	5D	CR1334	12A	Q1326	11B
C631	4C	CR1335	12A	Q1334	11B
C649	5E	CR1336	12A	Q1582	10E
C655	6C	CR1342	10D	Q1588	11E
C676	4E	CR1344	10D		
C678	9D	CR1345	10D		
C690	3E	CR1347	10D	R502	1B
C805	8C			R503	2B
C808	8B	DS834	1C	R507	4C
C824	9C	DS836	1C	R508	2C
C826	7E	DS1599	1C	R509	3C
C829	9B	DS1588	1C	R511	2A
C834	8C			R512	3B
C835	2C	J6	9E	R516	3B
C836	8C	J571	3C	R517	3B
C837	9D	J573	2C	R518	3B
C839	9D	J575	3C	R522	4B
C853	7D	J678	4E	R523	4B
C855	7D	J688	4E	R524	4B
C858	8D	J1317	9A	R525	4B
C863	7E	J1319	10A	R527	5B
C874	10D	J1337	10A	R528	4B
C877	9D	L507	4C	R529	4B
C879	9C	L546	5B	R531	4A
C891	11B	L547	5B	R535	4A
C893	11B	L646	6D	R536	5B
C896	2C	L647	6D	R537	5B
C897	11B	L874	10C	R538	5B
C1044	9F	L891	12C	R539	5B
C1307	10B	L893	12C	R540	5B
C1327	11B	L897	12C	R541	5B
C1339	12B			R542	5B
C1348	11B	P530	2A	R544	5B
C1349	11B	P630	1D	R545	5A
C1587	11E	P1040	8A	R546	6B
				R547	6B
				R549	5C
CR517	4B	Q522	4B	R550	6B
CR550	7B	Q524	4B	R551	7C
CR552	7B	Q550	6B	R552	6B
CR553	6B	Q552	7B	R553	6C
CR554	6B	Q622	4D	R554	6B
CR617	4D	Q624	4D	R555	6A
CR650	7D	Q650	6D	R556	6B
CR652	7D	Q652	6D	R557	6B
CR801	7B	Q672	5E	R558	7B

CKT NO	GRID LOC	CKT NO	GRID LOC	CKT NO	GRID LOC	CKT NO	GRID LOC
Q678	4E	R565	7C	R815	7B	R1584	10E
Q682	4E	R602	1E	R817	7B	R1585	10E
Q688	4E	R603	2E	R818	7B	R1597	10E
Q804	8B	R604	2D	R822	9B	R1587	10E
Q812	7B	R606	2E	R823	8C	R1589	10E
Q814	7B	R607	2D	R824	8C		
Q822	9B	R608	2D	R827	9C	RT557	6B
Q824	9B	R609	8E	R828	9B	RT657	6D
Q828	9B	R611	3E	R829	10B		
Q854	8D	R612	3D	R831	9B	S510	3B
Q862	7C	R616	4C	R834	8C	S515	3A
Q864	7C	R617	3D	R836	8C	S610	3D
Q1042	8A	R618	3D	R838	9D	S615	3D
Q1044	9A	R622	4D	R853	7D		
Q1052	9B	R623	4D	R854	7E	U540	5B
Q1054	9A	R624	4D	R855	7D	U640	5D
Q1304	10B	R625	4C	R856	7E	U870	9D
Q1306	10B	R627	5C	R857	8D		
Q1314	10A	R628	5D	R858	8D	VR875	9C
Q1324	11A	R629	5D	R859	7E	VR896	7C
Q1326	11B	R631	4C	R861	7D		
Q1334	11B	R635	4C	R862	7C		
Q1582	10E	R636	4C	R863	7E		
Q1588	11E	R637	5C	R864	7D		
		R638	5D	R865	7D		
		R639	5C	R866	7D		
R502	1B	R640	5C	R871	9C		
R503	2B	R641	5C	R872	9C		
R507	4C	R642	5C	R877	9C		
R508	2C	R644	5C	R879	9C		
R509	3C	R645	5C	R1041	8A		
R511	2A	R646	6D	R1044	9B		
R512	3B	R647	6D	R1045	8A		
R516	3B	R649	5E	R1046	8B		
R517	3B	R650	6D	R1047	8A		
R518	3B	R651	6E	R1048	8A		
R522	4B	R652	6D	R1049	8A		
R523	4B	R655	6C	R1052	8B		
R524	4B	R656	7C	R1053	8B		
R525	4B	R657	6D	R1054	8B		
R527	5B	R658	6E	R1057	8A		
R528	4B	R671	5E	R1301	10B		
R529	4B	R672	5E	R1302	10B		
R531	4A	R675	4D	R1303	10B		
R535	4A	R676	4E	R1304	11A		
R536	5B	R677	3E	R1306	10C		
R537	5B	R678	3E	R1307	10B		
R538	5B	R679	4F	R1308	10B		
R539	5B	R681	4D	R1314	11A		
R540	5B	R682	5E	R1315	11B		
R541	5B	R683	5E	R1317	10A		
R542	5B	R687	3E	R1321	12B		
R544	5B	R688	3E	R1322	11B		
R545	5A	R689	4F	R1323	11B		
R546	6B	R690	2E	R1324	12A		
R547	6B	R691	2E	R1326	10C		
R549	5C	R692	2E	R1327	11B		
R550	6B	R694	3F	R1328	11B		
R551	7C	R803	7B	R1334	12A		
R552	6B	R804	7B	R1335	11A		
R553	6C	R805	7B	R1337	10A		
R554	6B	R807	8B	R1339	12B		
R555	6A	R808	8B	R1345	10C		
R556	6B	R809	8B	R1348	11B		
R557	6B	R811	7B	R1349	11B		
R558	7B	R812	7A	R1581	10E		
		R814	7B				

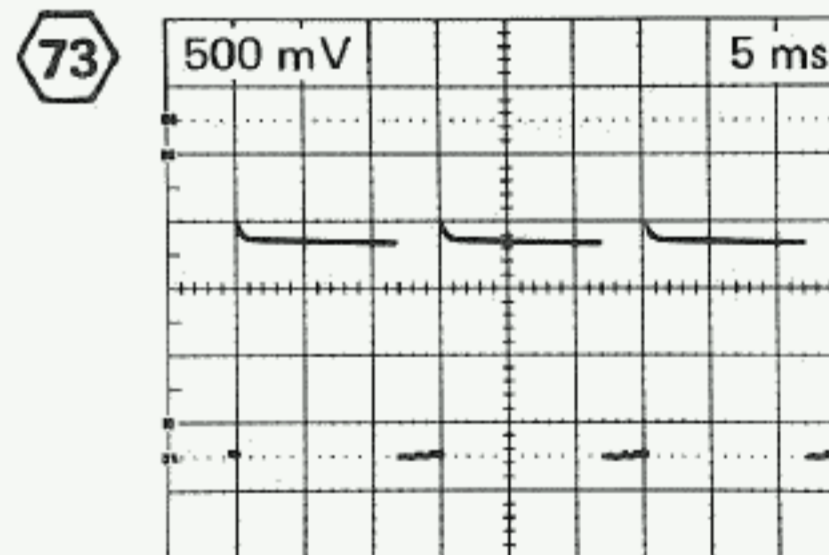
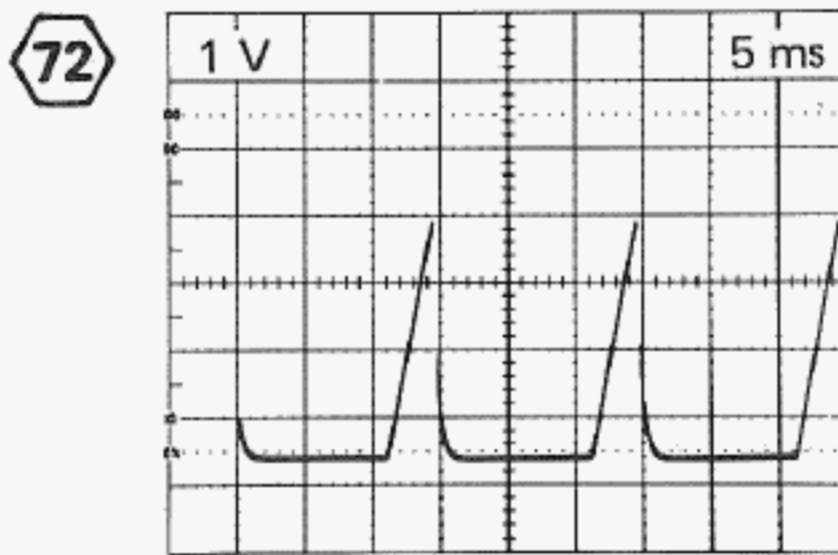
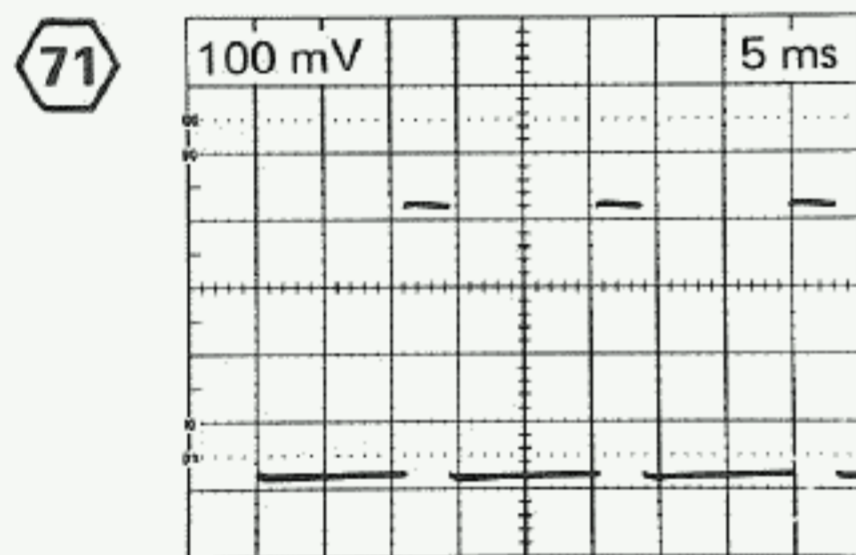
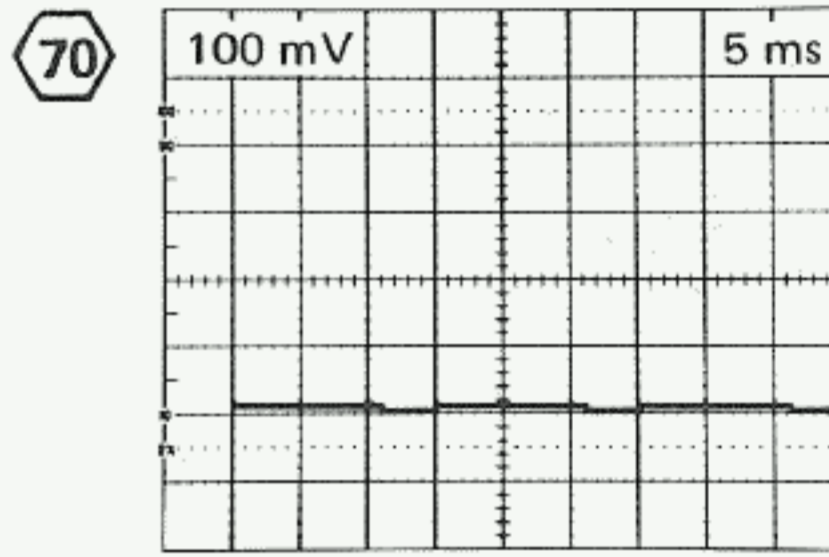
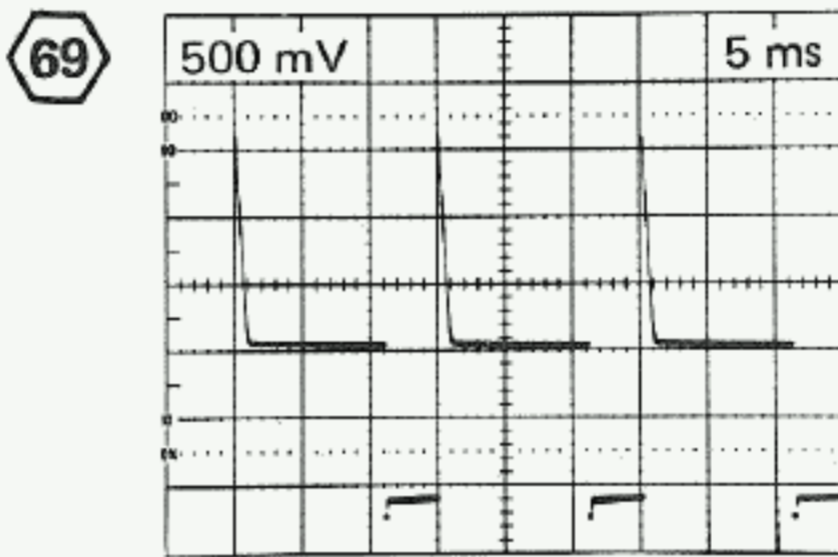
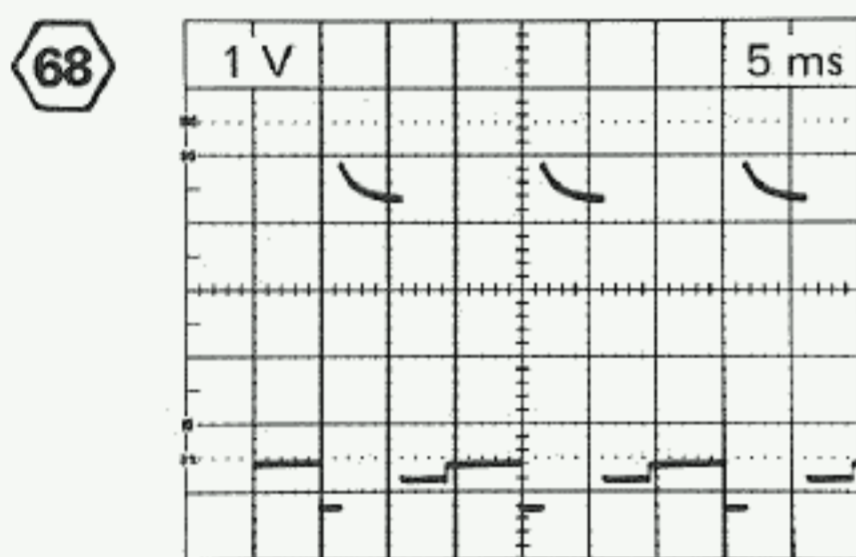
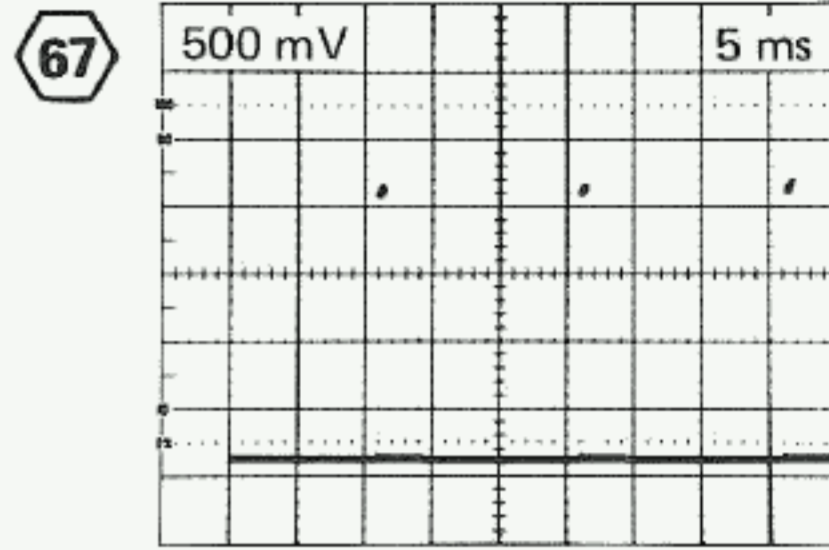
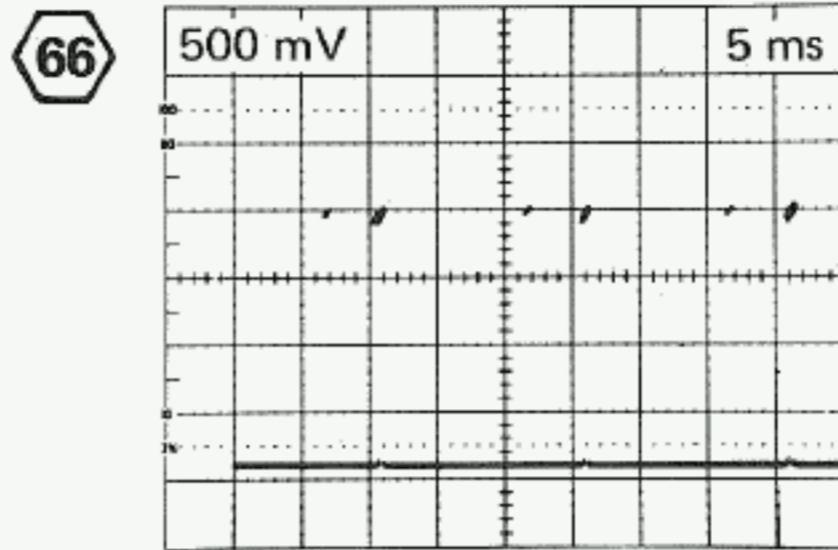
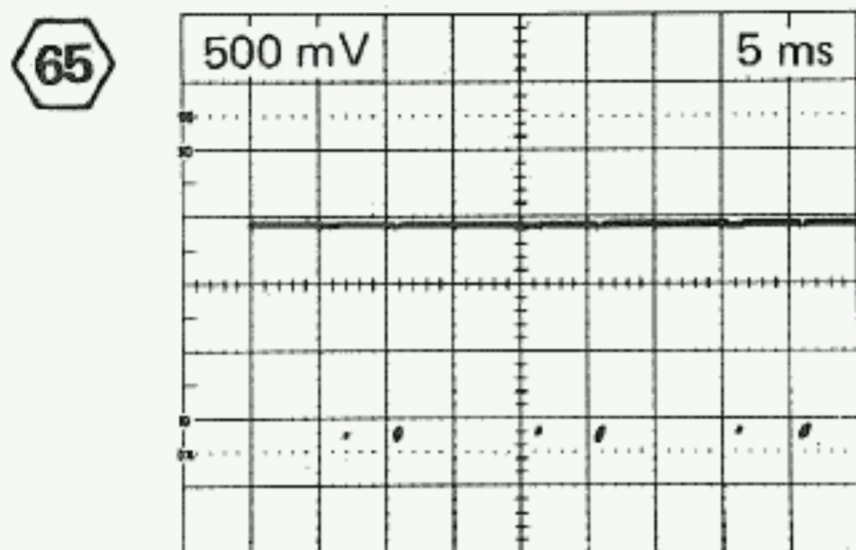
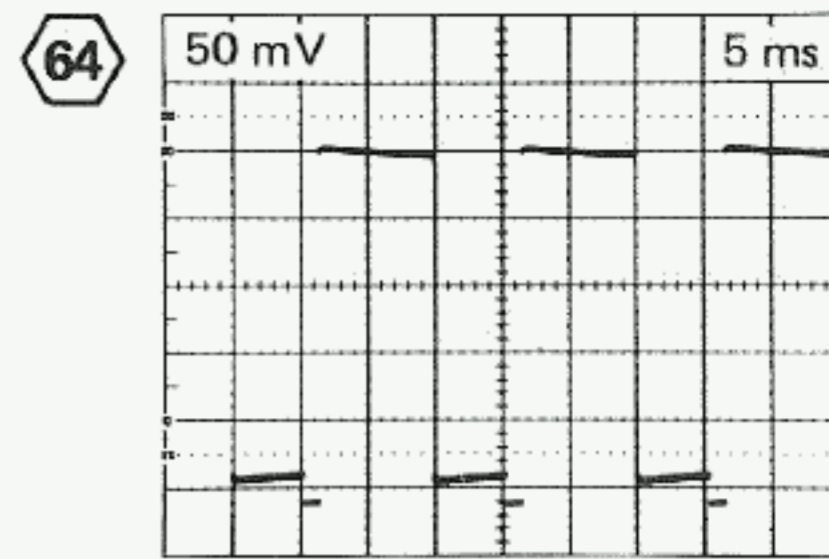
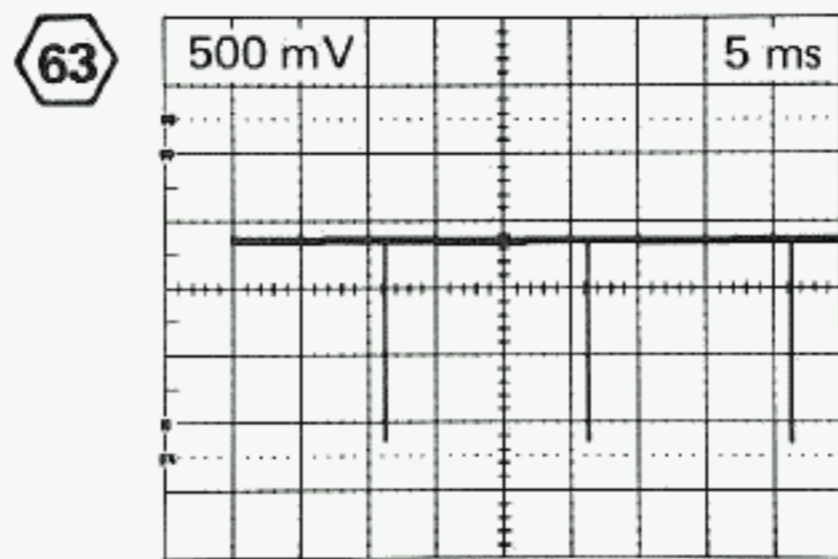
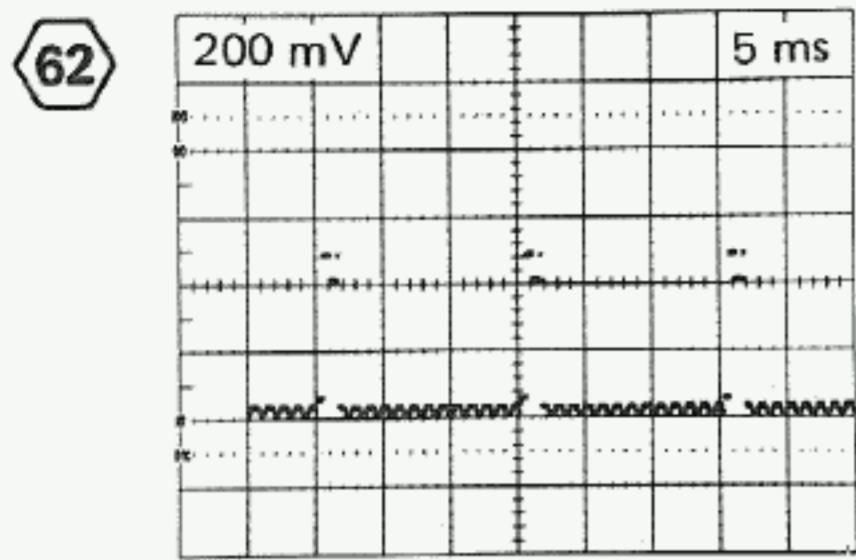

465 display untriggered (free running).

The slope and time duration of this waveform is dependent on the setting of the A Trigger Holdoff control.

465 display triggered (stable).

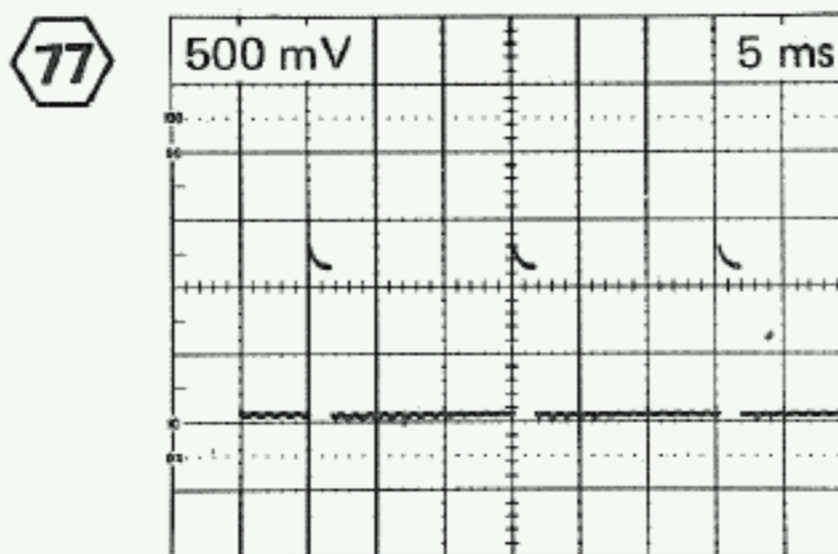
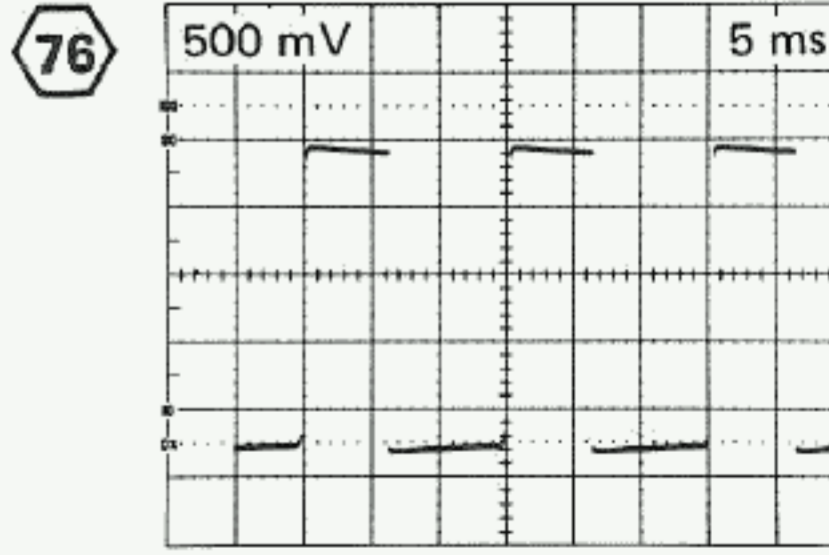
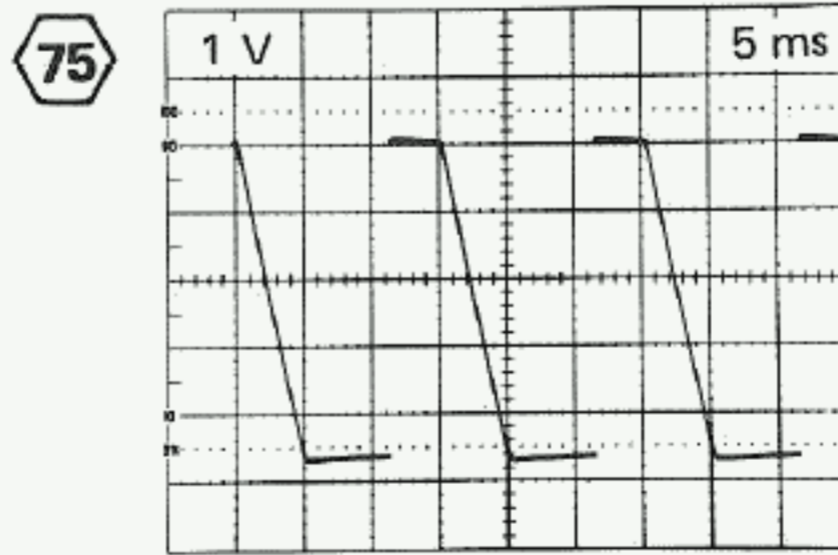
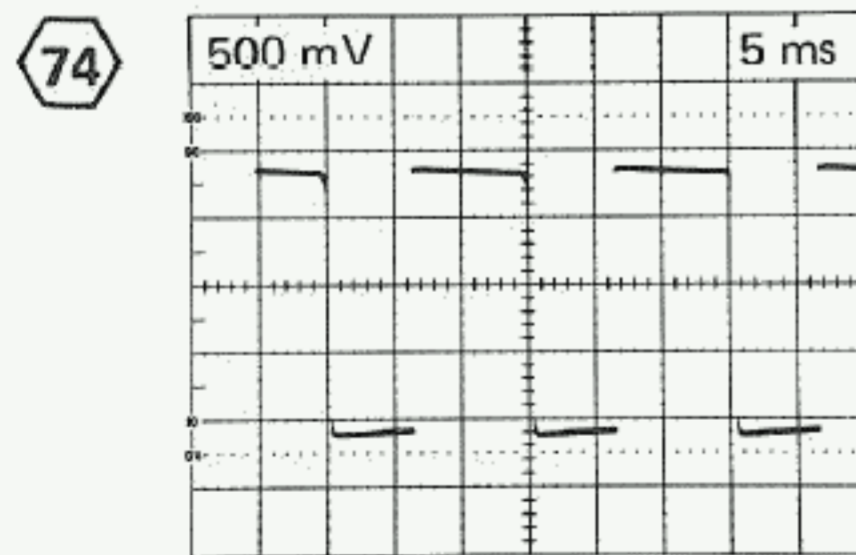

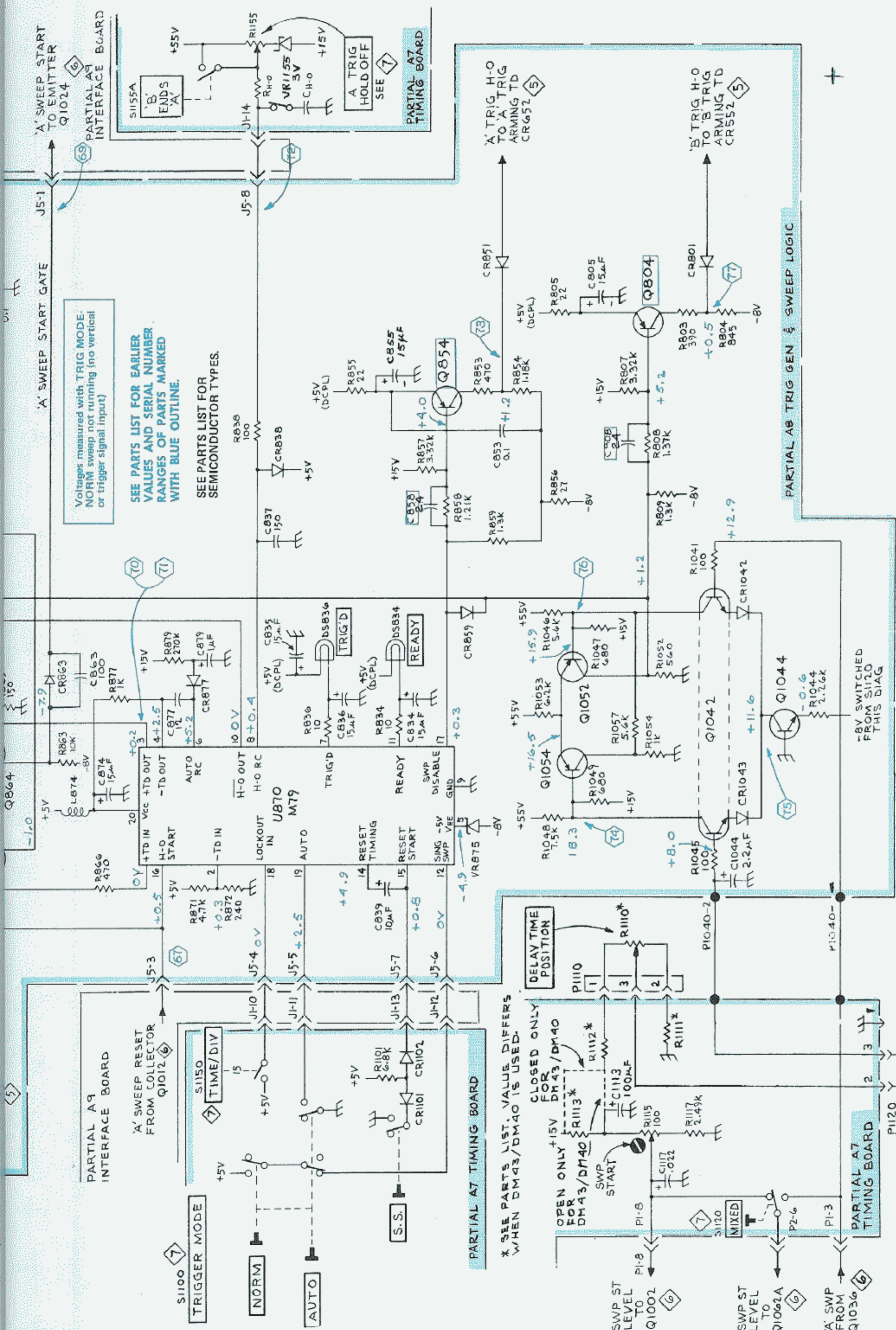

Volts measured with TRIG MODE-NORM sweep not running (no vertical or trigger signal input)

SEE PARTS LIST FOR EARLIER VALUES AND SERIAL NUMBER RANGES OF PARTS MARKED WITH BLUE OUTLINE.

SEE PARTS LIST FOR SEMICONDUCTOR TYPES.

* SEE PARTS LIST. VALUE DIFFERS WHEN DM43/DM40 IS USED.

DELAY TIME POSITION

OPEN ONLY FOR DM43/DM40

CLOSED ONLY FOR DM43/DM40

SWP START

MIXED

39f
874

SWEEP & Z AXIS LOGIC

SN B250000 and up

† Located on back of board
 * See parts list for serial number ranges
 2 Used only with Options 4 and 7
 3 Chassis Mounted

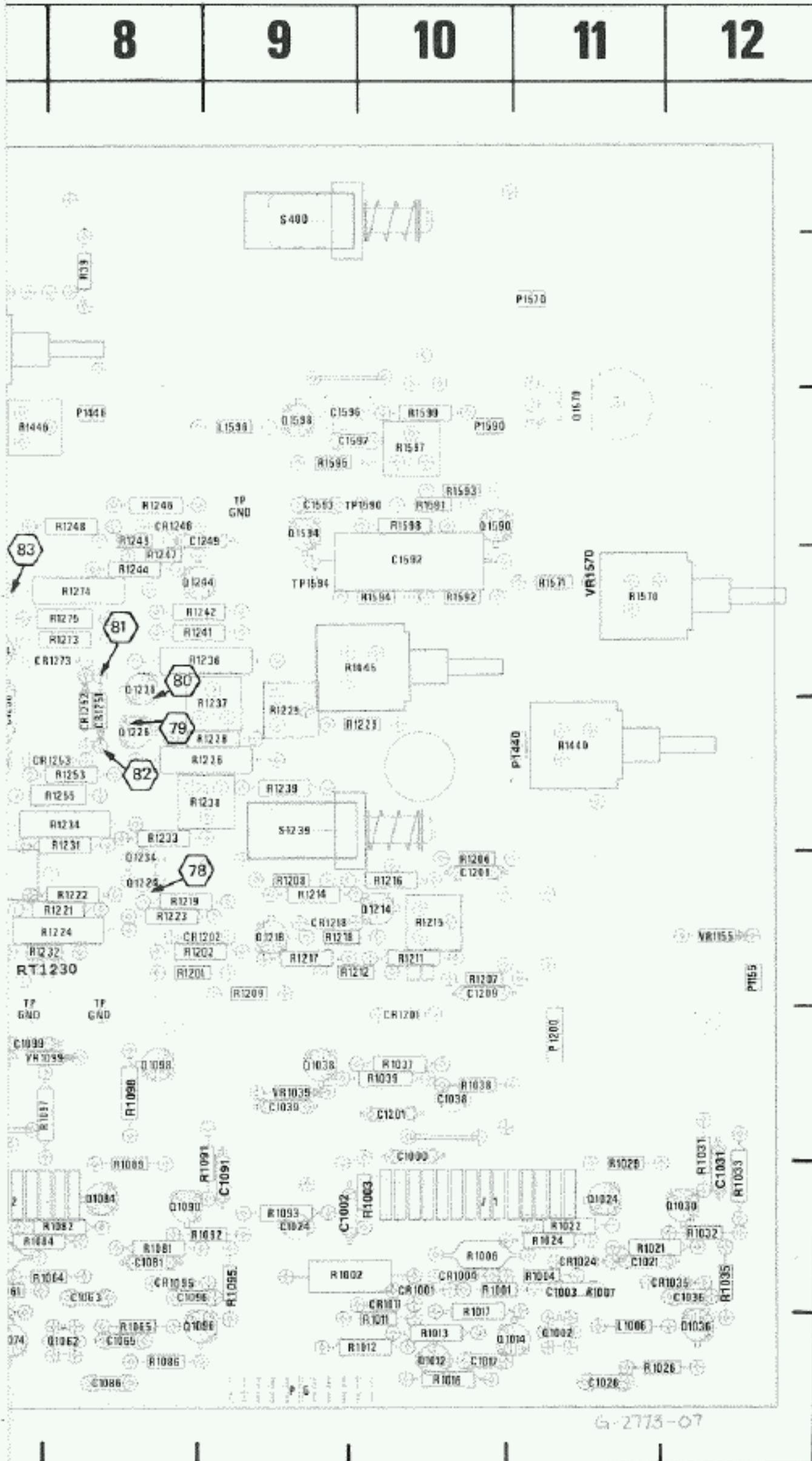

CKT NO	GRID LOC	CKT NO	GRID LOC	CKT NO	GRID LOC
C1000	10G	C1522	2F	CR1534	4G
C1002	9H	C1525	2F	CR1535	1F
C1003	11H	C1534	1F	CR1536	2F
C1017	10I	C1537	2F	CR1541	3H
C1021	11H	C1542	4H	CR1549	1G
C1024	9H	C1549	5F	CR1551	4I
C1026	11I	C1552	6H	CR1556	3F
C1031	12H	C1559	4F	CR1559	4F
C1036	12H	C1562	3G	CR1561	2G
C1038	10G	C1569	1E	CR1564	1C
C1039	9G	C1592	10D	CR1569	3H
C1038	10G	C1593	9C		
C1062	7H	C1596	9C	DS1425	3C
C1063	8H	C1597	9C	DS1426	3C
C1065	8I	C16812	1H		
C1077	7I	C16822	1H	F1419	2H
C1081	8H	C16832	2H		
C1084	6G	C16842	2I	J1	10H
C1086	8I	C16852	1H	J2	7H
C1091	9H			J3	6H
C1096	8H	CR1001	10H		
C1099	7G	CR1004	10H	L1006	11I
C1201	10G	CR1011	10H	L1419	1C
C1208	10F	CR1024	11H	L1596	9C
C1209	10F	CR1035	12H		
C1220	7F	CR1061	7H	P5	9I
C1235	7F	CR1064	7H	P6	6I
C1249	9C	CR1071	7H	P300	7B
C1256	7E	CR1095	8H	P1155	12F
C1261	7E	CR1201	10G	P1200	11G
C1262	6E	CR1202	8F	P1400	2B
C1263	6F	CR1218	9F	P1440	11E
C1269	7F	CR1248	8C	P1445	5A
C1281	7D	CR1251	8E	P1446	8C
C1282	6D	CR1252	8E	P1452	4E
C1283	7C	CR1253	8E	P1570	11B
C1288	7D	CR1255	7E	P1590	10C
C1403	4E	CR1273	8D		
C1404	4F	CR1275	7E	Q1002	11I
C1412	1B	CR1286	7D	Q1012	10I
C1416	2A	CR1404	4E	Q1014	11I
C1419	1A	CR1408	2B	Q1024	11H
C1420	2B	CR1412	1B	Q1030	12H
C1421	3B	CR1413	1B	Q1036	12I
C1422	4B	CR1414	1C	Q1038	9G
C1423	4B	CR1416	2A	Q1062	8I
C1424	4D	†CR1421	3A	Q1063	6H
C1427	1B	CR1427	2C	Q1072	7I
C1430	5B	CR1461	6G	Q1074	7I
C1442	5A	CR1462	3E	Q1084	8H
C1445	5B	CR1463	5E	Q1090	8H
C1447	6B	CR1464	6G	Q1096	9I
C1449	5A	CR1465	6C	Q1098	8G
C1452	4E	CR1468	3E	Q1214	9F
C1471	3D	CR1472	3E	Q1218	9F
C1474	3E	CR1476	2D	Q1224	8F
C1475	2D	CR1482	2C	Q1226	8E
C1476	2D	CR1483	2C	Q1234	8F
C1477	2D	CR1487	3C	Q1236	8D
C1481	1C	CR1488	4C	Q1244	8D
C1484	2C	CR1511	5H	Q1254	7E
C1487	3C	CR1514	4H	Q1262	6E
C1488	3C	CR1516	5H	Q1266	6E
C1510	5I	CR1524	2F	Q1274	7D
C1511	5I	CR1532	2F	Q1282	6D
C1512	5G	CR1533	1E	Q1286	6D
C1513	4G				

GRID LOC	CKT NO	GRID LOC	CKT NO	GRID LOC	CKT NO	GRID LOC	CKT NO	GRID LOC
	Q1404	4D	R1086	8I	R1284	6C	R1519	5G
	Q1408	5E	R1089	8H	R1286	6D	R1521	4G
	Q1413	1B	R1091	9H	R1288	7D	R1523	2F
	Q1414	1C	R1092	9H	R1289	6F	R1524	4G
	Q1416	2A	R1093	9H	R1400	5F	R1525	2F
	Q1418 ³		R1095	9H	R1401	4E	R1527	2F
	Q1466	3E	R1097	8G	R1402	5E	R1528	4F
	Q1472	3E	R1098	8G	R1403	5E	R1532	1E
	Q1474	2D	R1201	8F	R1404	4E	R1533	2E
	Q1478	2D	R1202	8F	R1406	5E	R1534	1F
	Q1516	4H	R1206	10F	R1407	5D	R1537	2F
	Q1518	5G	R1207	10F	R1408	4F	R1538	2F
	Q1532	1E	R1208	9F	R1409	2A	R1539	2G
	Q1534	1E	R1209	9F	R1411	1B	R1543	2G
	Q1536	2E	R1211	10F	R1412	1B	R1544	2G
	Q1544	1G	R1212	10F	R1413	1B	R1546	1G
	Q1546	1F	R1215	10F	R1414	1B	R1547	2G
	Q1548	1G	R1216	10F	R1416	1B	R1549	1G
	Q1556	3F	R1217	9F	R1420	2C	R1553	1E
	Q1558	3F	R1218	9F	R1421	4B	R1554	1E
	Q1564	1D	R1219	8F	R1422	4C	R1556	3F
	Q1566	1D	R1220	7F	R1423	4C	R1557	2F
	Q1568	1D	R1221	8F	R1427	1B	R1559	3F
	Q1570	11C	R1222	8F	R1428	2B	R1563	1E
	Q1590	10C	R1223	8F	R1430	5C	R1564	2E
	Q1594	9C	R1224	8F	R1431	4D	R1565	2E
	Q1598	9C	R1225	9E	R1434	7B	R1566	1D
			R1226	9E	R1440	11E	R1567	1D
	R39	8B	R1228	9E	R1442	7C	R1569	1D
	R1001	10H	R1229	9E	R1445	10D	R1570	11D
	R1002	9H	R1231	8E	R1446	7C	R1571	11D
	R1003	10H	R1232	8F	R1447	6A	R1591	10C
	R1004	11H	R1233	8E	R1448	6A	R1592	10D
	R1006	10H	R1234	8E	R1449	6A	R1593	10C
	R1007	11H	R1235	7G	R1451	4E	R1594	10D
	R1011	10I	R1236	8D	R1452	4E	R1595	9C
	R1012	10I	R1237	9E	R1453	4E	R1597	10C
	R1013	10I	R1238	9E	R1460	7B	R1598	10C
	R1016	10I	R1239	9E	R1461	6G	R1599	10C
	R1017	10H	R1241	8D	R1462	4D	RT1230	8F
	R1021	11H	R1242	8D	R1463	6C	S400	9A
	R1022	11H	R1244	8D	R1464	4F	S1239	9E
	R1024	11H	R1246	8C	R1466	4E	†T1420	2A
	R1026	11I	R1247	8D	R1467	4E	TP1486	3D
	R1029	11H	R1248	8D	R1468	3E	TP1518	6F
	R1031	12H	R1249	8C	R1469	3D	TP1536	5F
	R1032	12H	R1253	8E	R1470	3E	TP1548	5F
	R1033	12H	R1254	6F	R1471	4E	TP1558	5F
	R1035	12H	R1255	8E	R1472	3E	TP1568	5F
	R1037	10G	R1260	7E	R1473	3E	TP1590	10C
	R1038	10G	R1261	6E	R1474	3E	TP1594	9D
	R1039	10G	R1262	6F	R1475	2D		
	R1061	7H	R1263	6F	R1476	2D	†U1432	5B
	R1062	6H	R1264	6F	R1477	3E	U1524	2G
	R1063	7H	R1266	6E	R1478	3D	U1554	1E
	R1064	8H	R1268	7F	R1480	2D		
	R1065	8I	R1269	6F	R1481	2C	VR1039	9G
	R1066	7H	R1273	8D	R1482	3C	VR1099	7G
	R1071	6I	R1274	8D	R1484	2C	VR1155	12F
	R1072	6I	R1275	8D	R1485	3D	VR1289	6F
	R1073	7I	R1280	6D	R1486	4C	VR1428	2B
	R1076	7I	R1281	7D	R1488	2C	VR1484	2C
	R1077	7H	R1282	6C	R1510	5I	VR1515	4G
	R1081	8H	R1283	6D	R1511	4I	VR1522	3G
	R1082	8H			R1516	4H	VR1525	1F
	R1084	8H			R1517	6G	VR1526	2G
					R1518	5H	VR1533	3F
							VR1570	11C

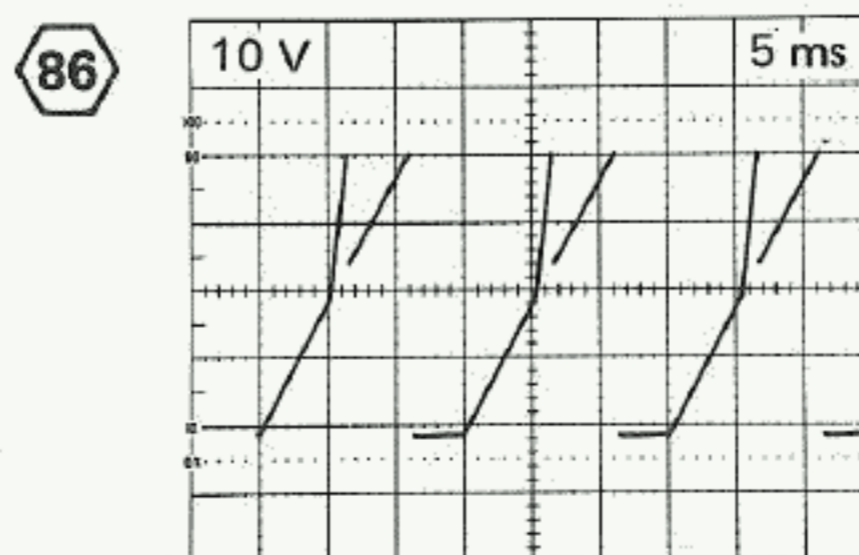
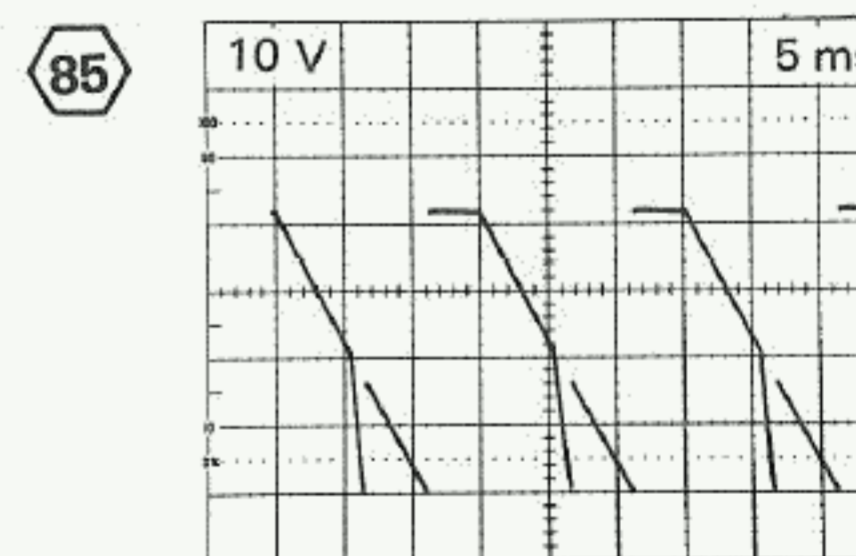
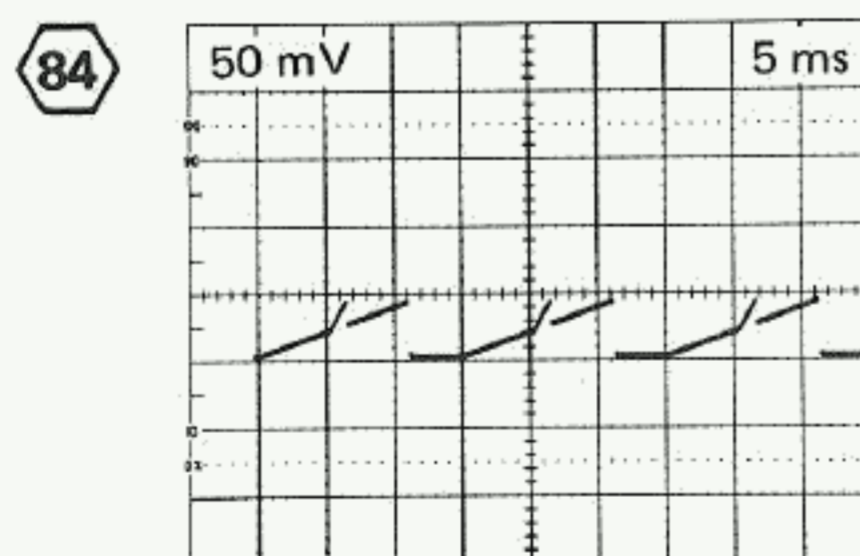
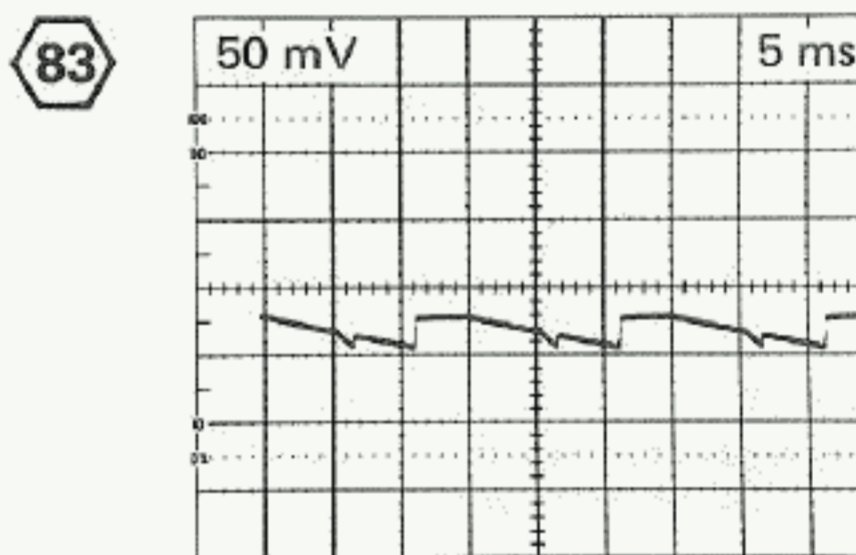
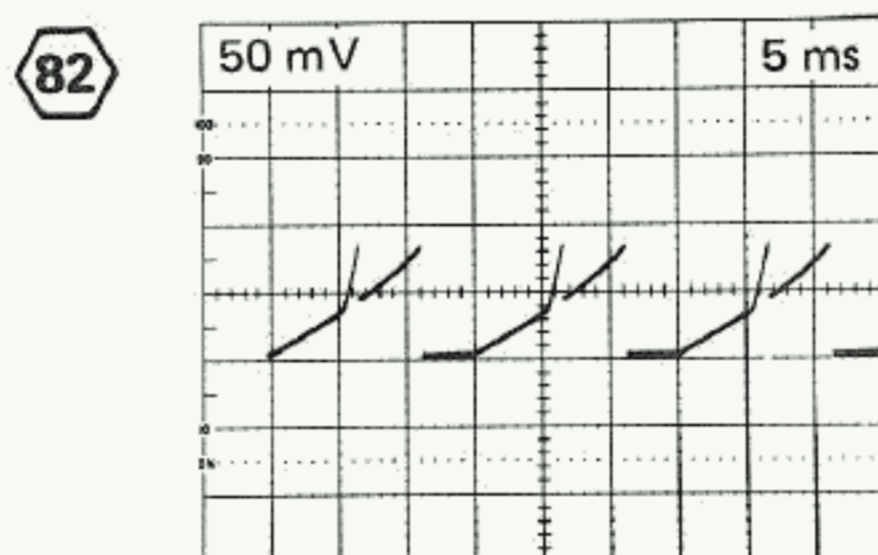
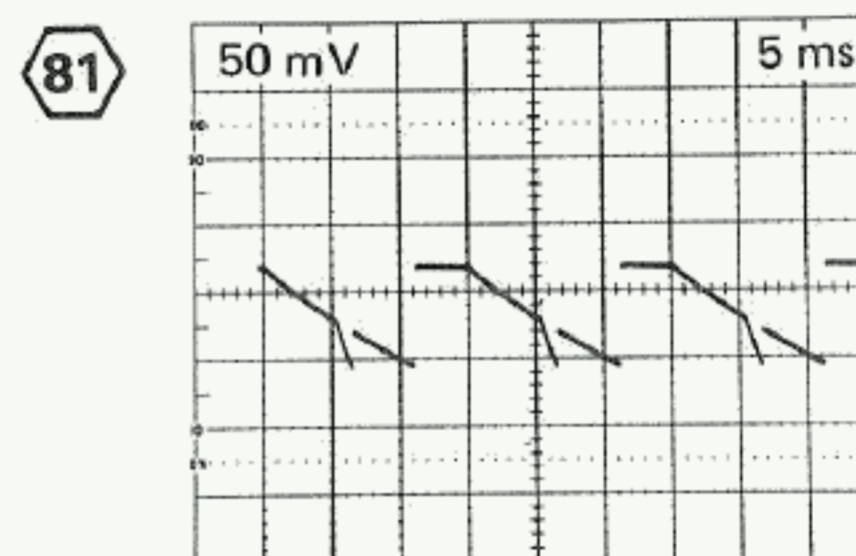
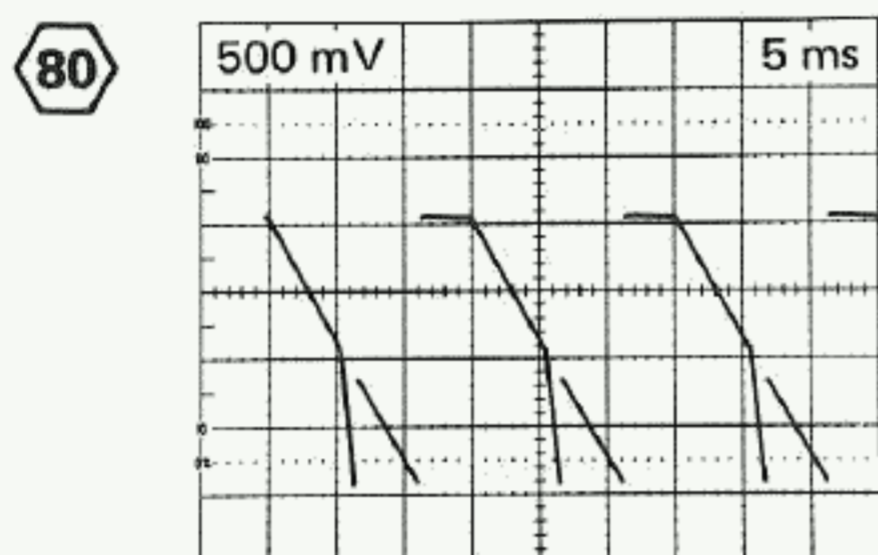
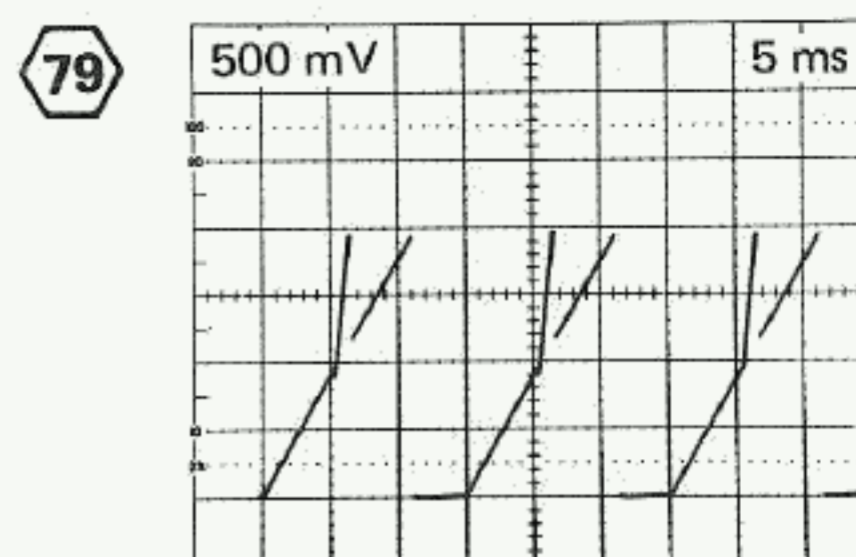
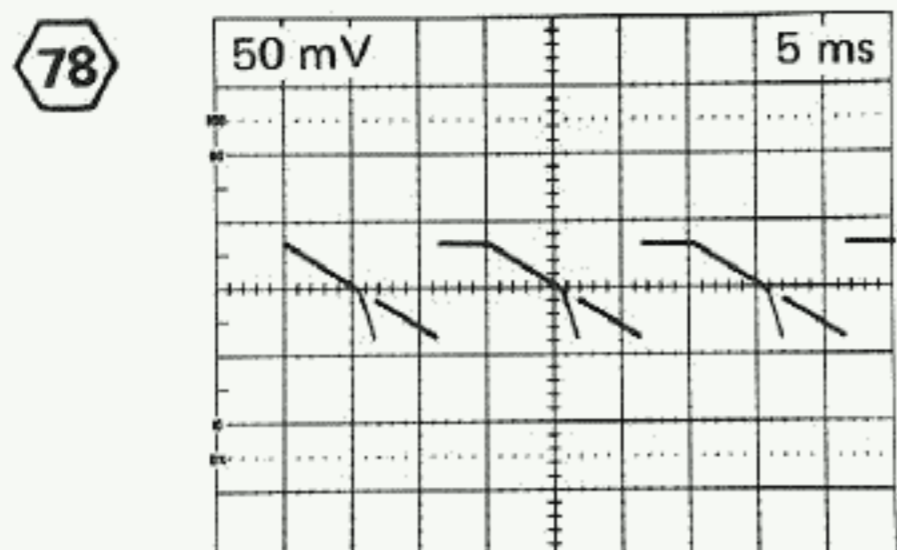

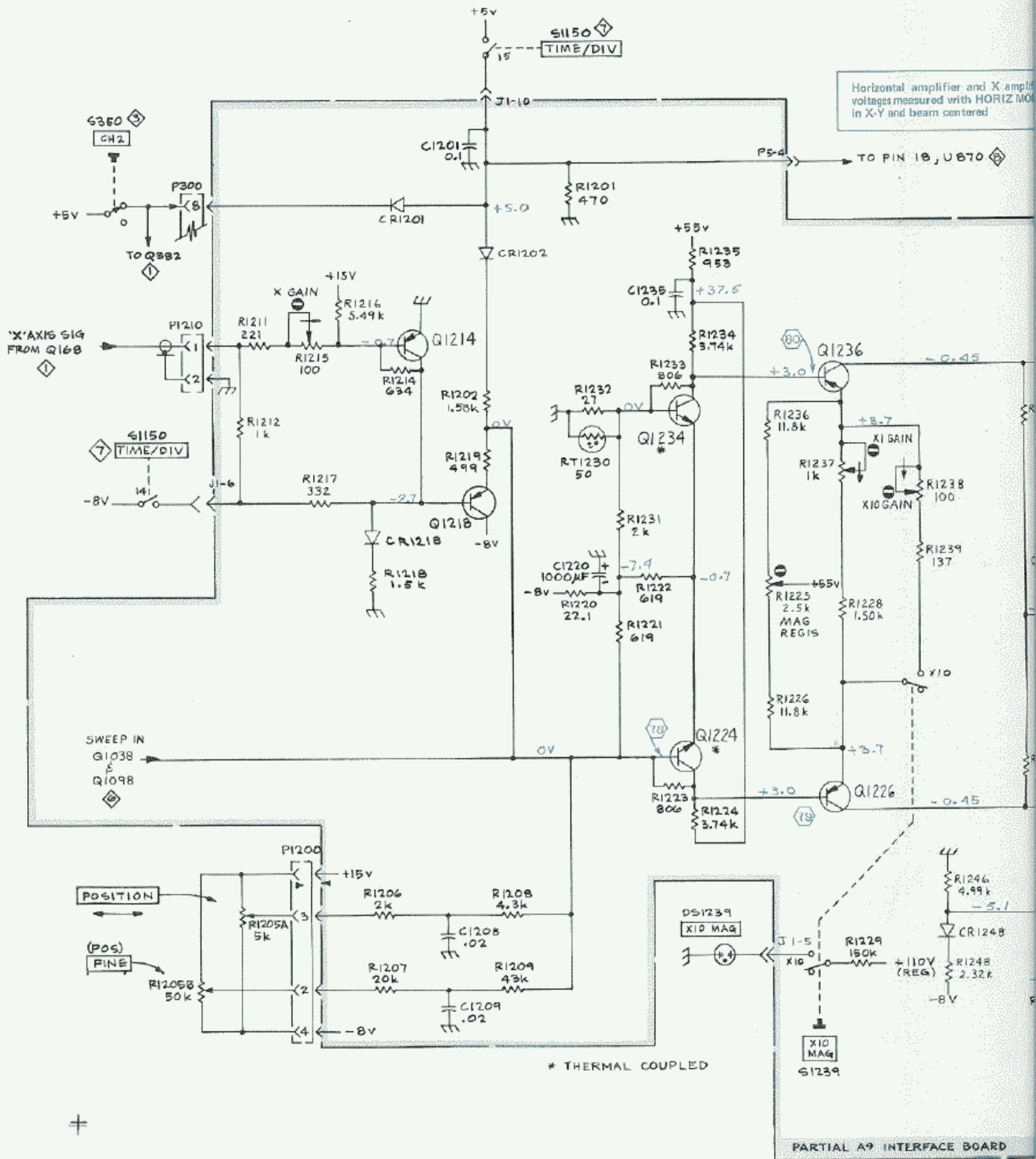

+

Horizontal amplifier and X amplifier voltages measured with HORIZ MODE in X-Y and beam centered

TO PIN 18, U870

36

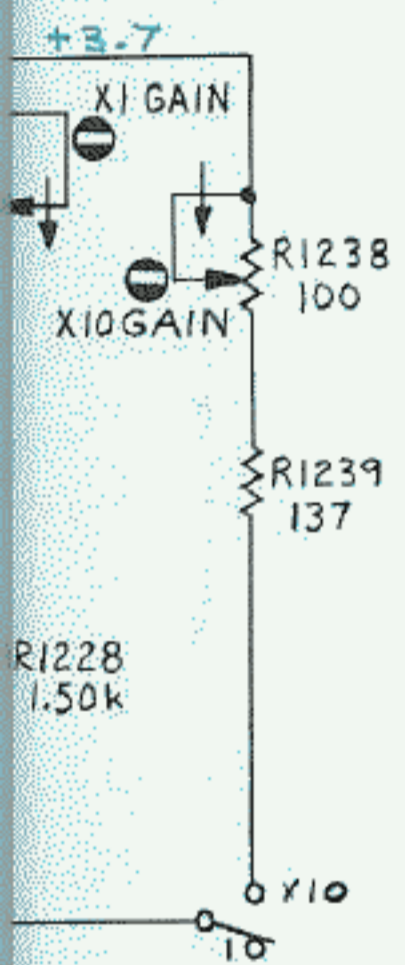

+3.7

+3.7

R1229 150k

A9 INTERFACE BOARD

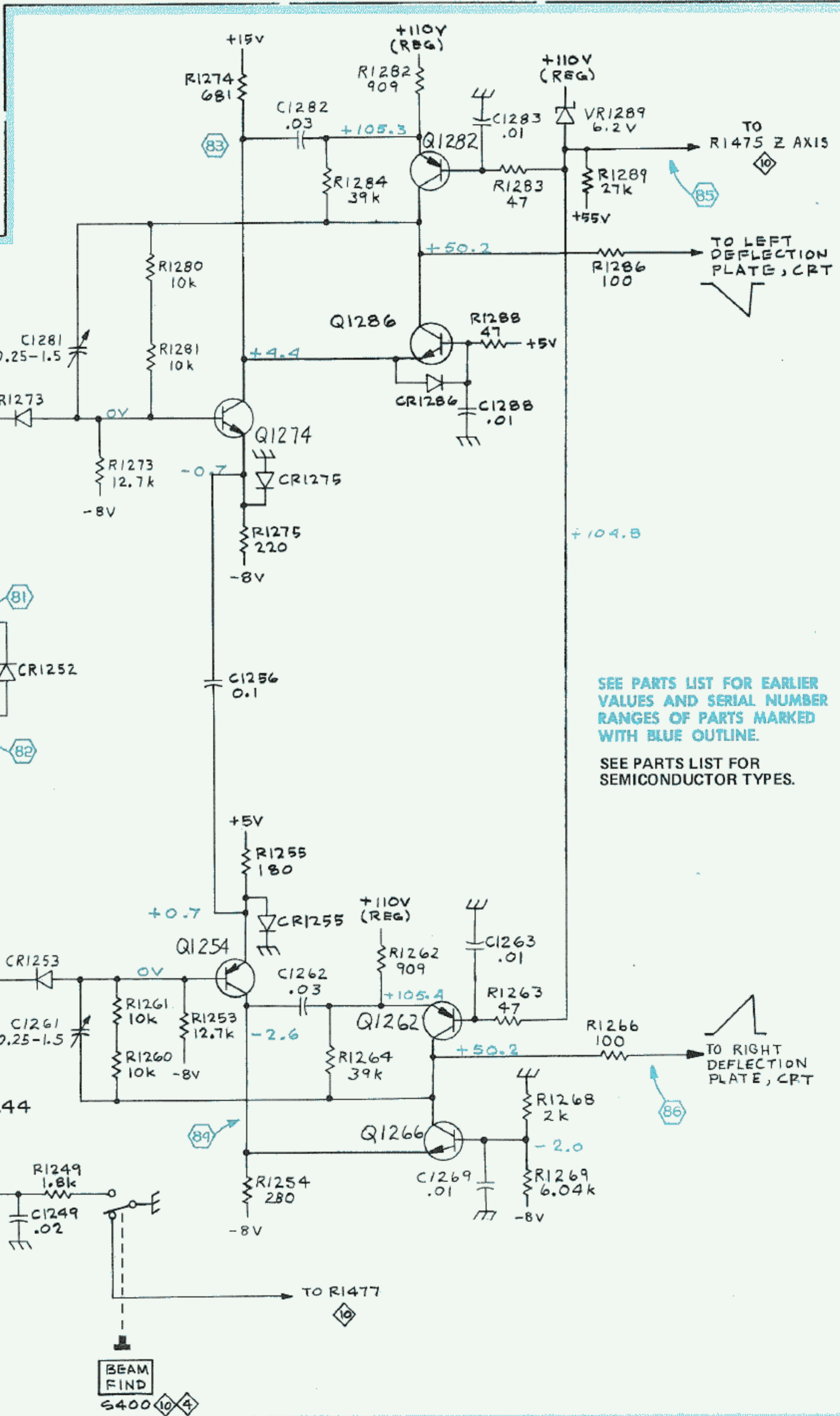

SEE PARTS LIST FOR EARLIER VALUES AND SERIAL NUMBER RANGES OF PARTS MARKED WITH BLUE OUTLINE.

SEE PARTS LIST FOR SEMICONDUCTOR TYPES.

HORIZONTAL AMPLIFIER 874
 SN B250000 and up

HORIZONTAL AMPLIFIER

9

ID C	CKT NO	GRID LOC	CKT NO	GRID LOC	CKT NO	GRID LOC	CKT NO	GRID LOC	CKT NO	GRID LOC
	CR1534	4G	Q1404	4D	R1086	8I	R1284	6C	R1519	5G
	CR1535	1F	Q1408	5E	R1089	8H	R1286	6D	R1521	4G
	CR1536	2F	Q1413	1B	R1091	9H	R1288	7D	R1523	2F
	CR1541	3H	Q1414	1C	R1092	9H	R1289	6F	R1524	4G
	CR1549	1G	Q1416	2A	R1093	9H	R1400	5F	R1525	2F
	CR1551	4I	Q1418 ³		R1095	9H	R1401	4E	R1527	2F
	CR1556	3F	Q1466	3E	R1097	8G	R1402	5E	R1528	4F
	CR1559	4F	Q1472	3E	R1098	8G	R1403	5E	R1532	1E
	CR1561	2G	Q1474	2D	R1201	8F	R1404	4E	R1533	2E
	CR1564	1C	Q1478	2D	R1202	8F	R1406	5E	R1534	1F
	CR1569	3H	Q1516	4H	R1206	10F	R1407	5D	R1537	2F
			Q1518	5G	R1207	10F	R1408	4F	R1538	2F
	DS1425	3C	Q1532	1E	R1208	9F	R1409	2A	R1539	2G
	DS1426	3C	Q1534	1E	R1209	9F	R1411	1B	R1543	2G
			Q1536	2E	R1211	10F	R1412	1B	R1544	2G
	F1419	2H	Q1544	1G	R1212	10F	R1413	1B	R1546	1G
			Q1546	1F	R1215	10F	R1414	1B	R1547	2G
	J1	10H	Q1548	1G	R1216	10F	R1416	1B	R1549	1G
	J2	7H	Q1556	3F	R1217	9F	R1420	2C	R1553	1E
	J3	6H	Q1558	3F	R1218	9F	R1421	4B	R1554	1E
			Q1564	1D	R1219	8F	R1422	4C	R1556	3F
	L1006	11I	Q1566	1D	R1220	7F	R1423	4C	R1557	2F
	L1419	1C	Q1568	1D	R1221	8F	R1427	1B	R1559	3F
	L1596	9C	Q1570	11C	R1222	8F	R1428	2B	R1563	1E
			Q1590	10C	R1223	8F	R1430	5C	R1564	2E
	P5	9I	Q1594	9C	R1224	8F	R1431	4D	R1565	2E
	P6	6I	Q1598	9C	R1225	9E	R1434	7B	R1566	1D
	P300	7B			R1226	9E	R1440	11E	R1567	1D
	P1155	12F	R39	8B	R1228	9E	R1442	7C	R1569	1D
	P1200	11G	R1001	10H	R1229	9E	R1445	10D	R1570	11D
	P1400	2B	R1002	9H	R1231	8E	R1446	7C	R1571	11D
	P1440	11E	R1003	10H	R1232	8F	R1447	6A	R1591	10C
	P1445	5A	R1004	11H	R1233	8E	R1448	6A	R1592	10D
	P1446	8C	R1006	10H	R1234	8E	R1449	6A	R1593	10C
	P1452	4E	R1007	11H	R1235	7G	R1451	4E	R1594	10D
	P1570	11B	R1011	10I	R1236	8D	R1452	4E	R1595	9C
	P1590	10C	R1012	10I	R1237	9E	R1453	4E	R1597	10C
			R1013	10I	R1238	9E	R1460	7B	R1598	10C
	Q1002	11I	R1016	10I	R1239	9E	R1461	6G	R1599	10C
	Q1012	10I	R1017	10H	R1241	8D	R1462	4D	RT1230	8F
	Q1014	11I	R1021	11H	R1242	8D	R1463	6C	S400	9A
	Q1024	11H	R1022	11H	R1244	8D	R1464	4F	S1239	9E
	Q1030	12H	R1024	11H	R1246	8C	R1466	4E	†T1420	2A
	Q1036	12I	R1026	11I	R1247	8D	R1467	4E	TP1486	3D
	Q1038	9G	R1029	11H	R1248	8D	R1468	3E	TP1518	6F
	Q1062	8I	R1031	12H	R1249	8C	R1469	3D	TP1536	5F
	Q1063	6H	R1032	12H	R1253	8E	R1470	3E	TP1548	5F
	Q1072	7I	R1033	12H	R1254	6F	R1471	4E	TP1558	5F
	Q1074	7I	R1035	12H	R1255	8E	R1472	3E	TP1568	5F
	Q1084	8H	R1037	10G	R1260	7E	R1473	3E	TP1590	10C
	Q1090	8H	R1038	10G	R1261	6E	R1474	3E	TP1594	9D
	Q1096	9I	R1039	10G	R1262	6F	R1475	2D		
	Q1098	8G	R1061	7H	R1263	6F	R1476	2D	†U1432	5B
	Q1214	9F	R1062	6H	R1264	6F	R1477	3E	U1524	2G
	Q1218	9F	R1063	7H	R1266	6E	R1478	3D	U1554	1E
	Q1224	8F	R1064	8H	R1268	7F	R1480	2D		
	Q1226	8E	R1065	8I	R1269	6F	R1481	2C	VR1039	9G
	Q1234	8F	R1066	7H	R1273	8D	R1482	3C	VR1099	7G
	Q1236	8D	R1071	6I	R1274	8D	R1484	2C	VR1155	12F
	Q1244	8D	R1072	6I	R1275	8D	R1485	3D	VR1289	6F
	Q1254	7E	R1073	7I	R1280	6D	R1486	4C	VR1428	2B
	Q1262	6E	R1076	7I	R1281	7D	R1488	2C	VR1484	2C
	Q1266	6E	R1077	7H	R1282	6C	R1510	5I	VR1515	4G
	Q1274	7D	R1081	8H	R1283	6D	R1511	4I	VR1522	3G
	Q1282	6D	R1082	8H			R1516	4H	VR1525	1F
	Q1286	6D	R1084	8H			R1517	6G	VR1526	2G
							R1518	5H	VR1533	3F
									VR1570	11C

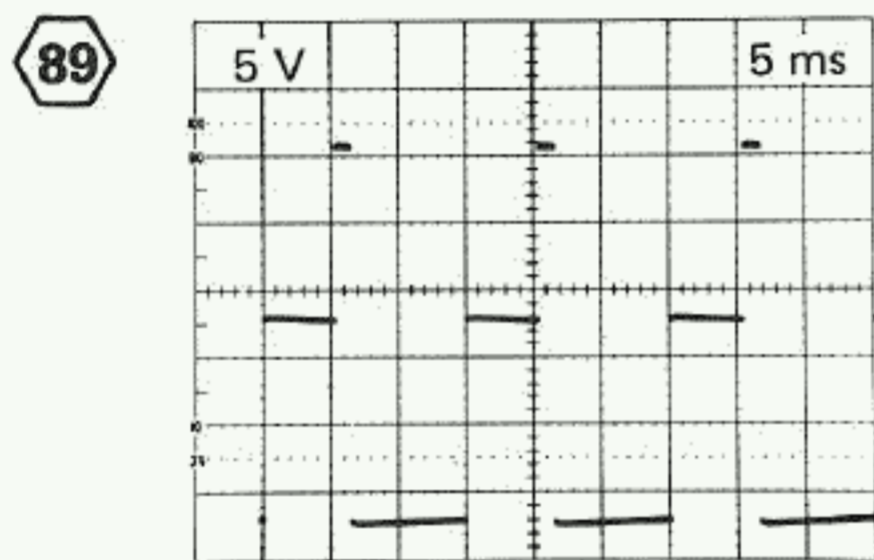
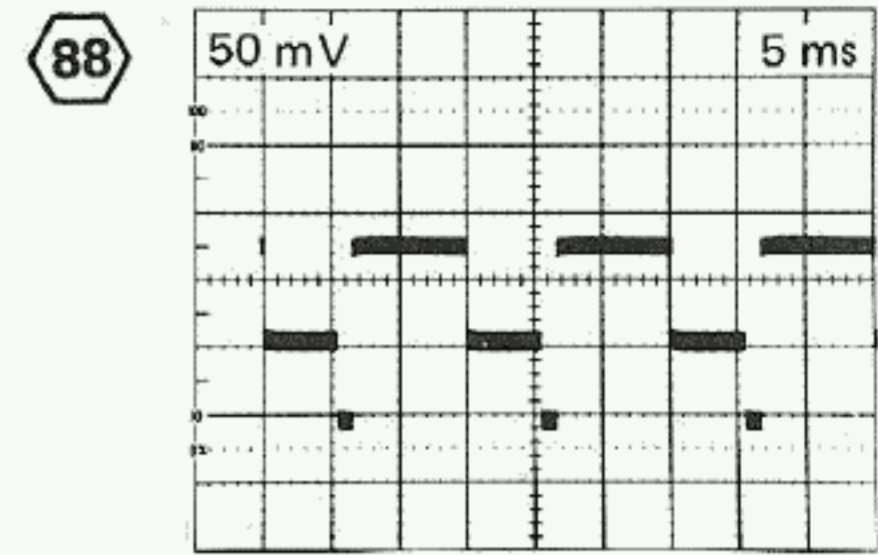
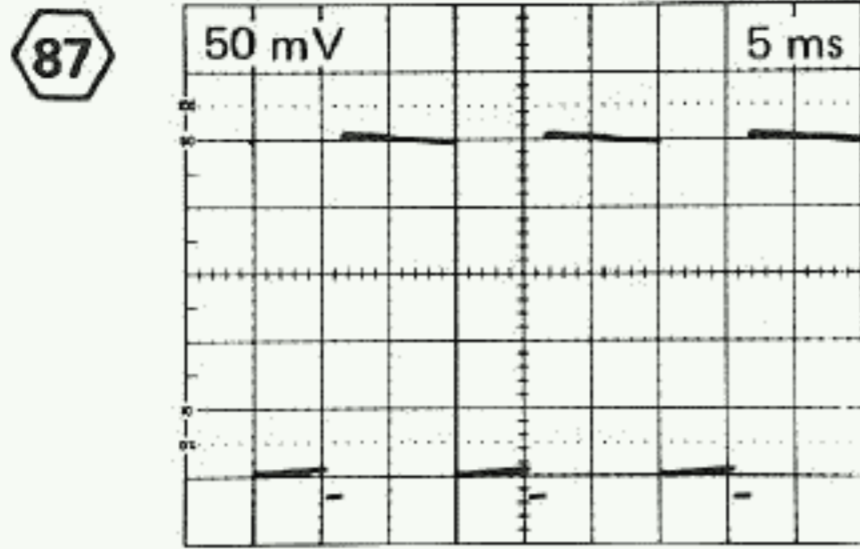

The amplitude of this waveform varies from 0 volts to 75 volts peak-to-peak depending on the setting of the Intensity control.

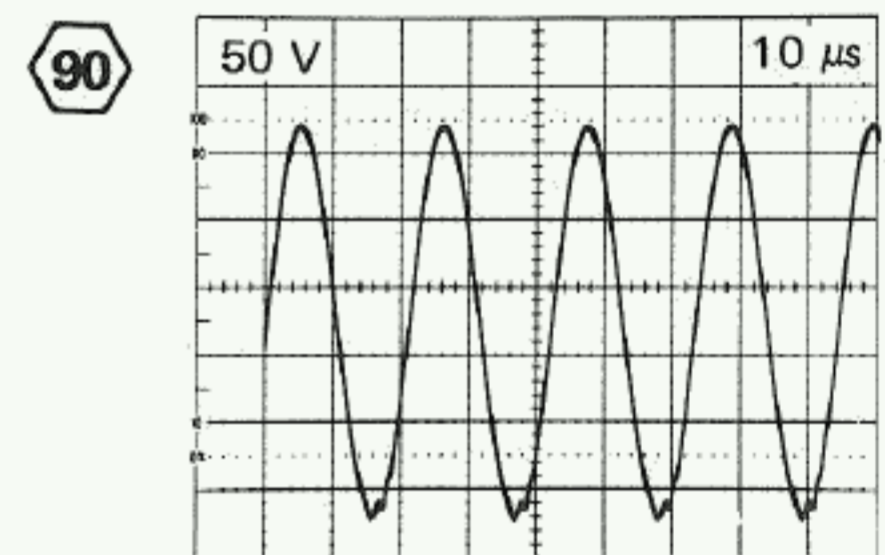

Set the test scope Trigger Source switch to Normal.

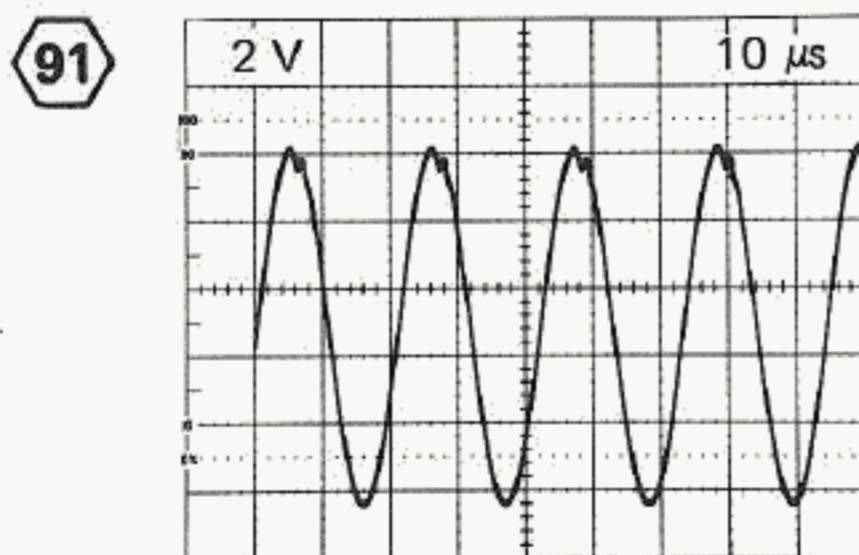

Set the test scope Trigger Source switch to Normal.

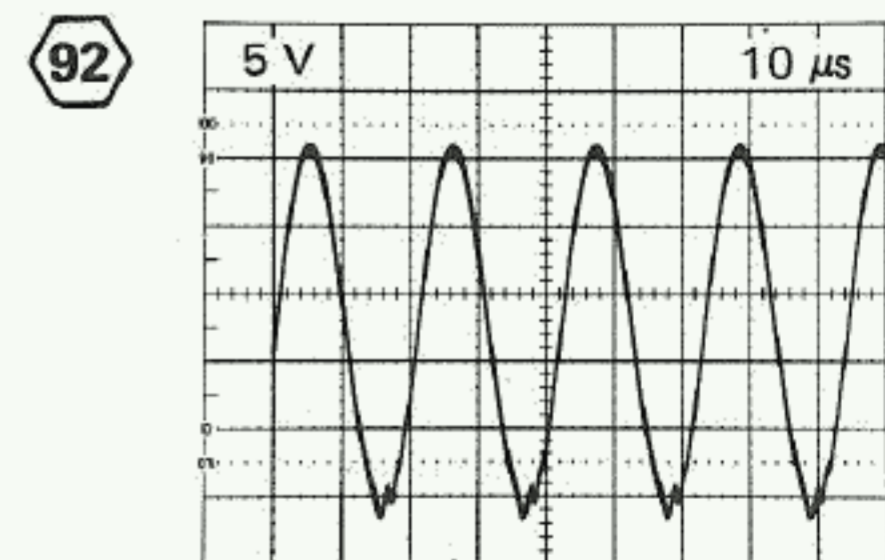

Set the test scope Trigger Source switch to Normal.

SEE PARTS LIST FOR EARLIER
VALUES AND SERIAL NUMBER
RANGES OF PARTS MARKED
WITH BLUE OUTLINE.

SEE PARTS LIST FOR
SEMICONDUCTOR TYPES.

+

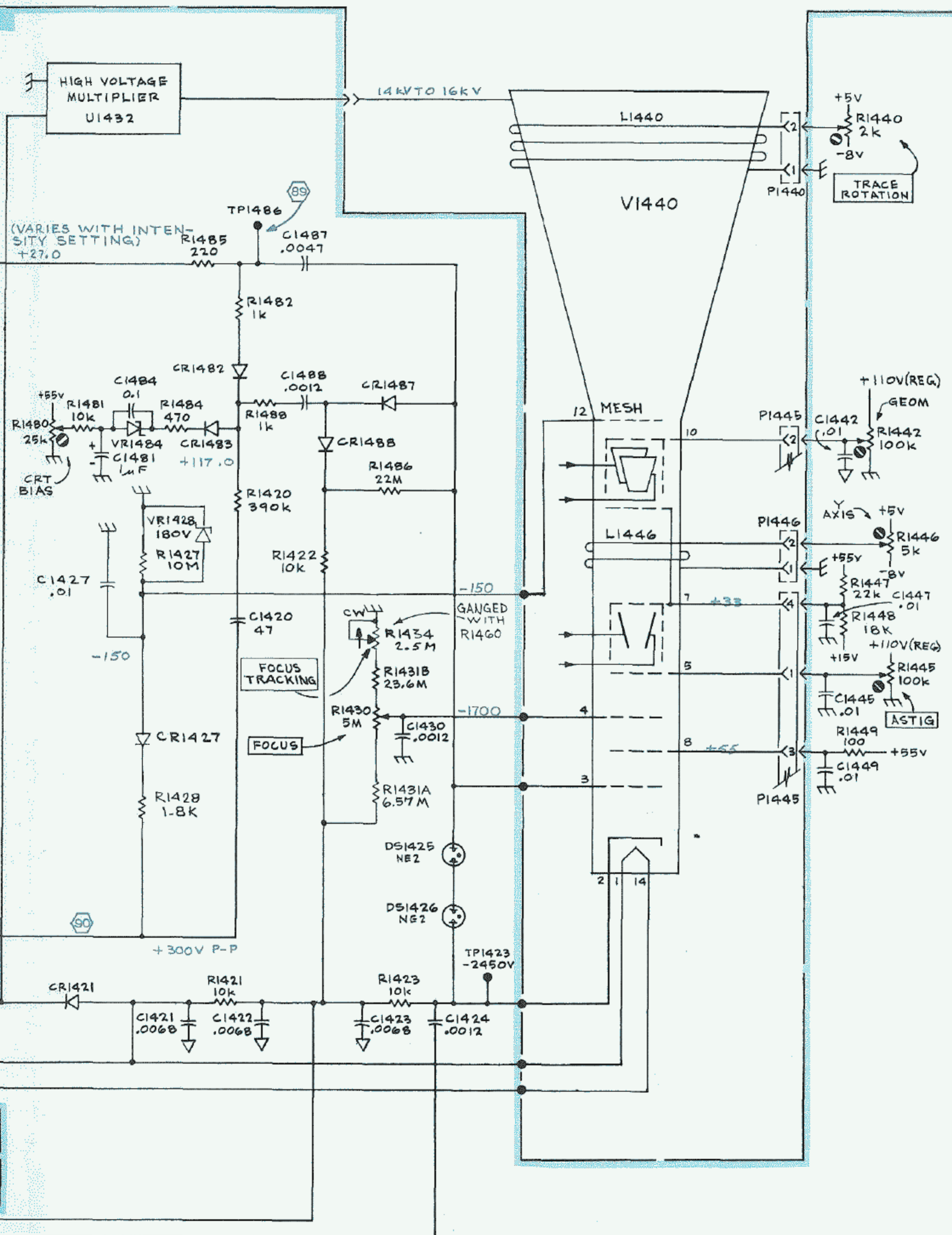

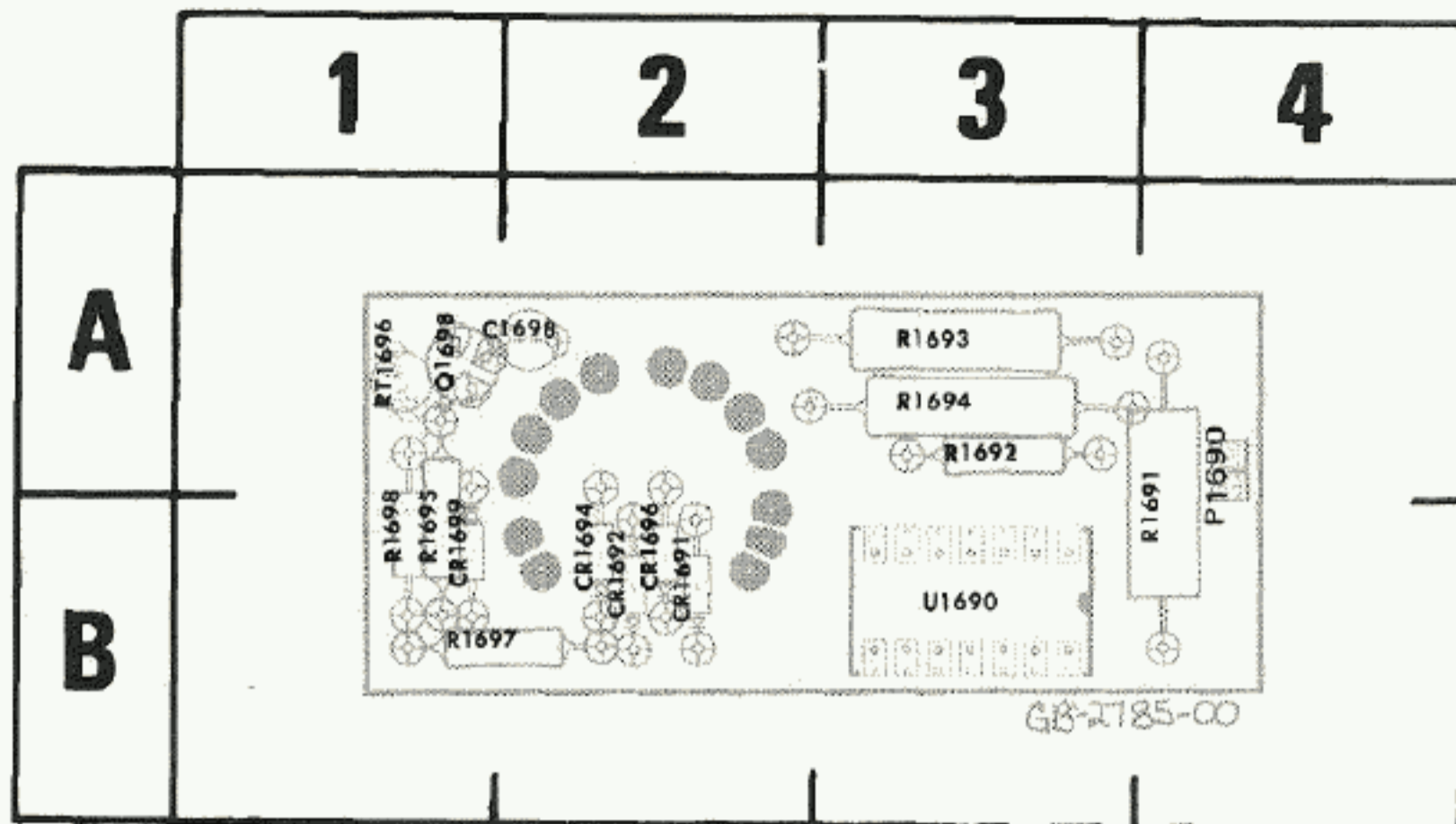
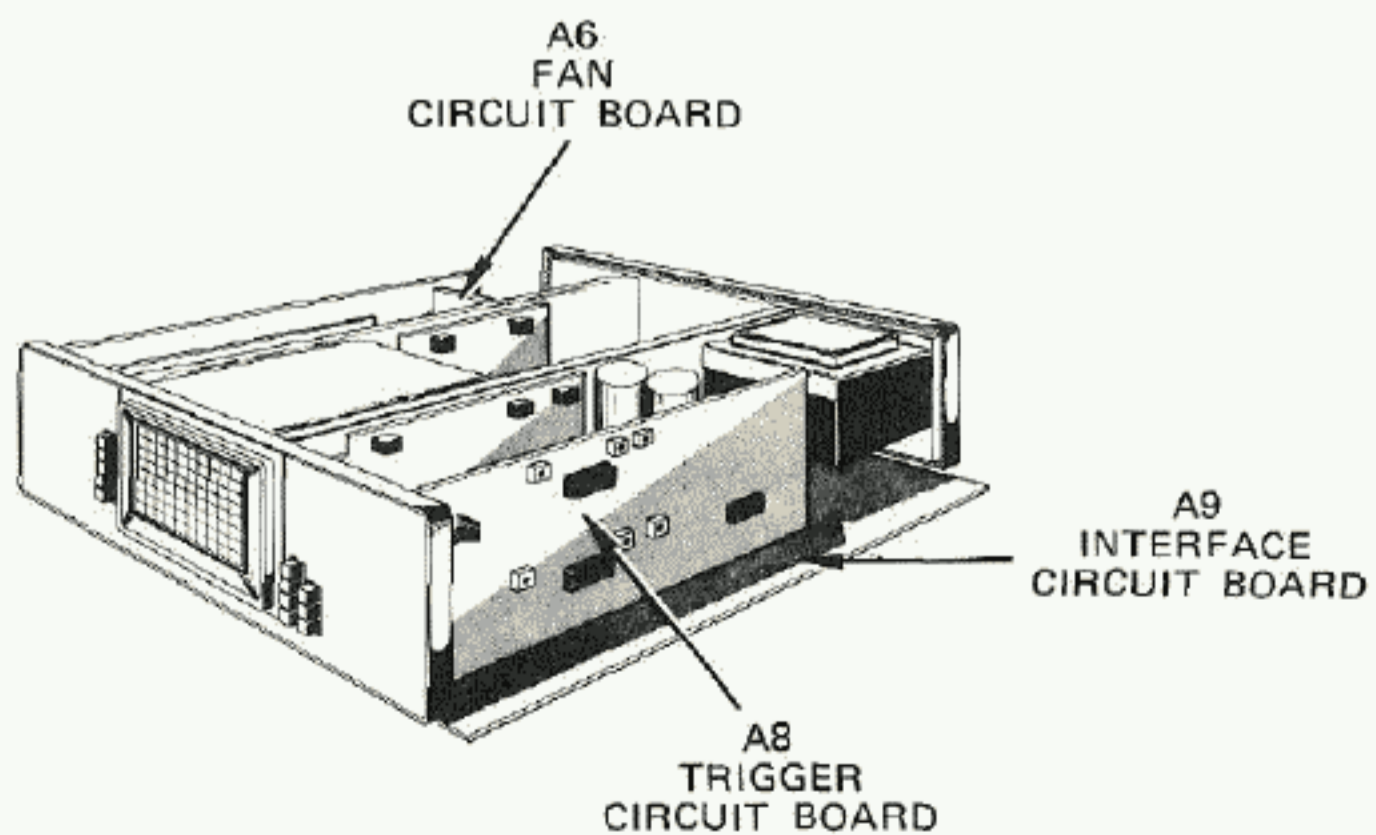

Fig. 8-15. A6--Fan circuit board.

CKT NO	GRID LOC	CKT NO	GRID LOC
C1698	2A	R1692	3A
CR1691	2B	R1693	3A
CR1692	2B	R1694	3A
CR1694	2B	R1697	1B
CR1696	2B	R1698	1B
CR1699	1B	R1695	1B
P1690	4A	RT1696	1A
Q1698	1A	U1690	3B
R1691	4A		

@



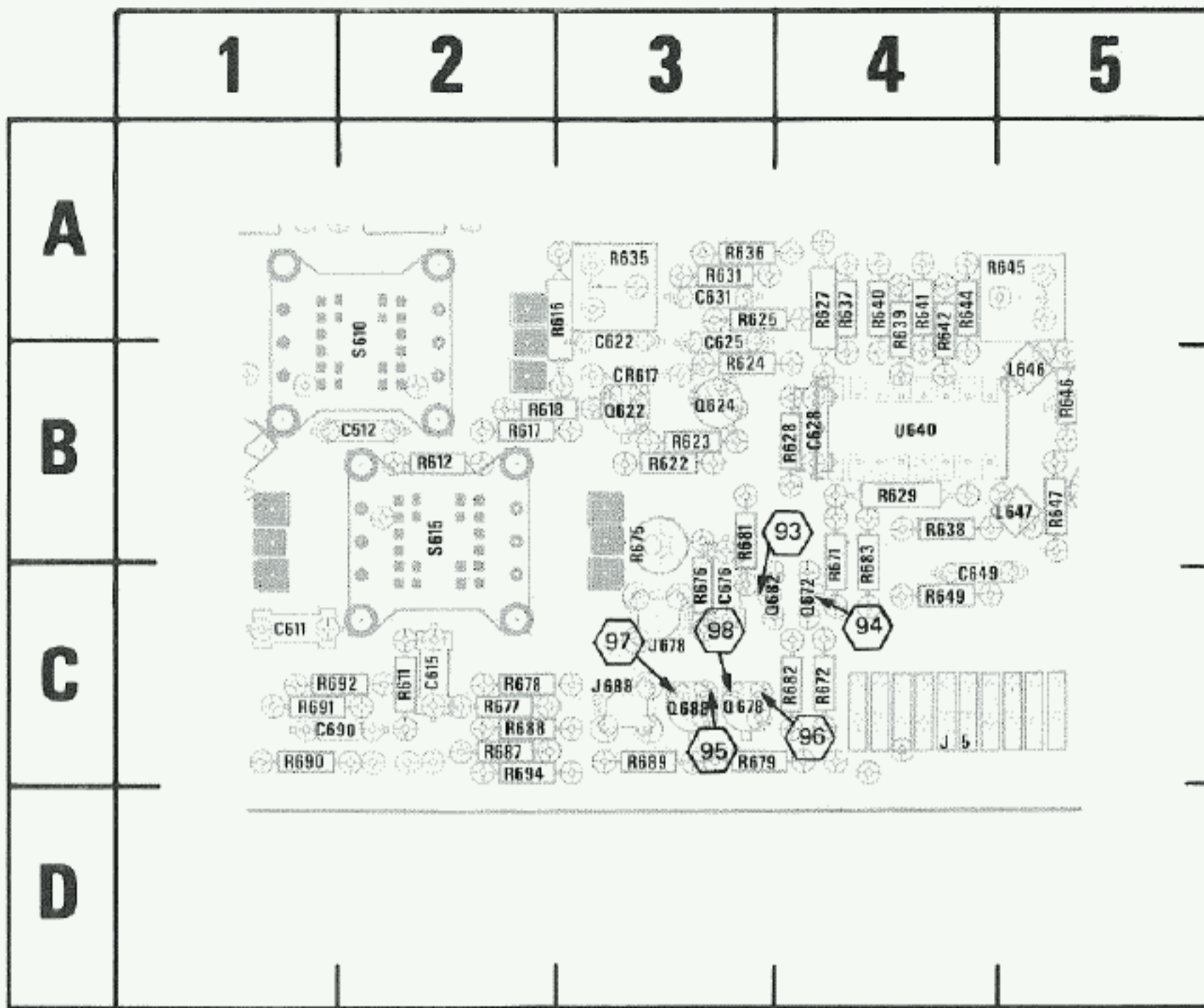

Fig. 8-16. Partial A8-Trigger Generator and Sweep Logic circuit boards.

CKT NO	GRID LOC	CKT NO	GRID LOC	CKT NO	GRID LOC	CKT NO	GRID LOC
C611	1C	Q622	3B	R631	3A	R678	2C
C612	2B	Q624	3B	R635	3A	R679	3C
C615	2C	Q672	4C	R636	3A	R681	3B
C622	3A	Q678	3C	R637	4A	R682	4C
C625	3A	Q682	3C	R638	4B	R683	4C
C628	4B	Q688	3C	R639	4A	R687	2C
C631	3A			R640	4A	R688	2C
C649	4C	R611	2C	R641	4A	R689	3C
C676	3C	R612	2B	R642	4A	R690	1C
C690	1C	R616	2A	R644	4A	R691	1C
		R617	2B	R645	5A	R692	1C
CR617	3B	R618	2B	R646	5B	R694	2C
		R622	3B	R647	5B		
J5	4C	R623	3B	R649	4C	S610	2A
J678	3C	R624	3B	R671	4C	S615	2B
J688	3C	R625	3A	R672	4C		
		R627	4A	R675	3B	U640	4B
L646	5B	R628	4B	R676	3C		
L647	5B	R629	4B	R677	2C		

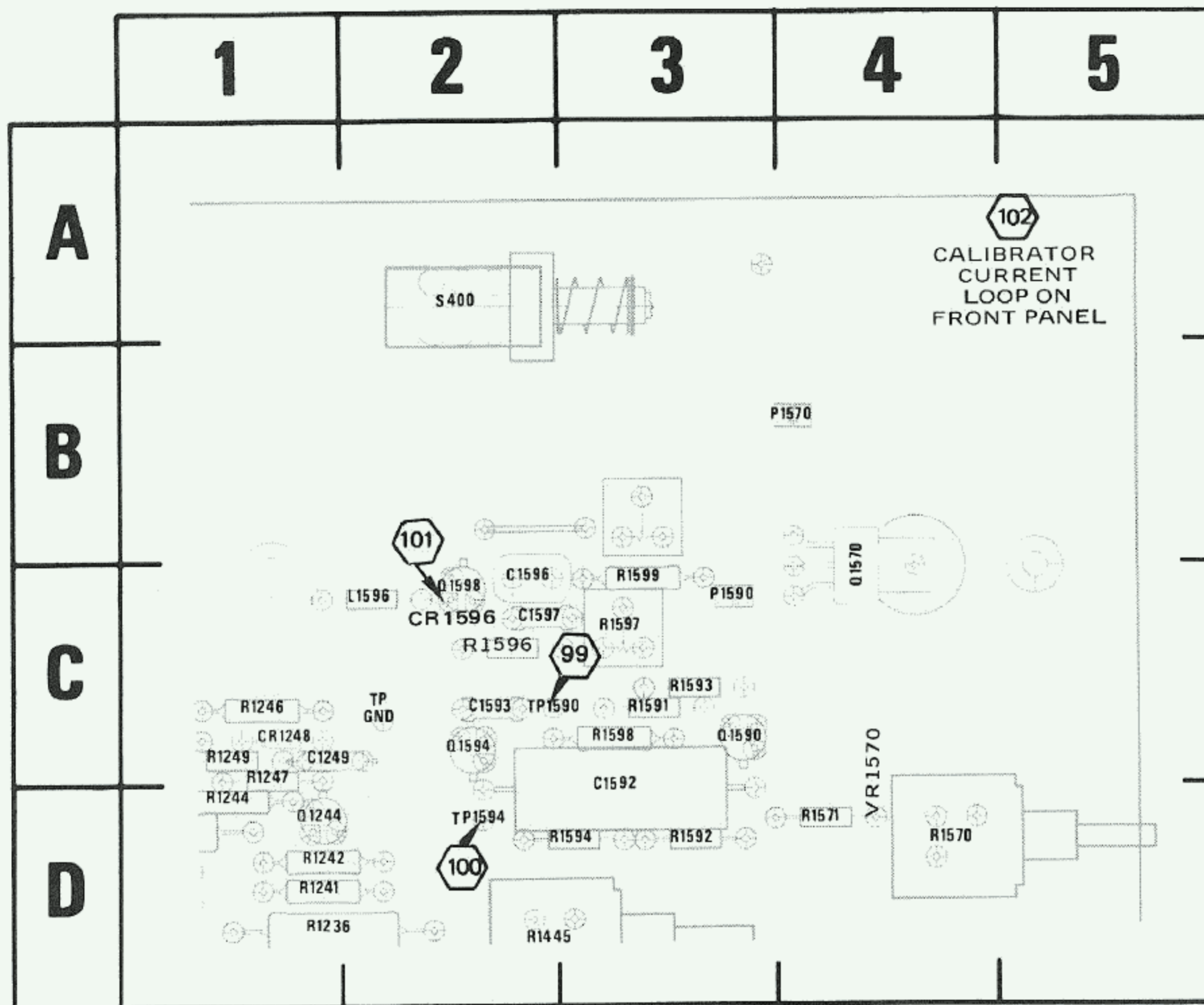
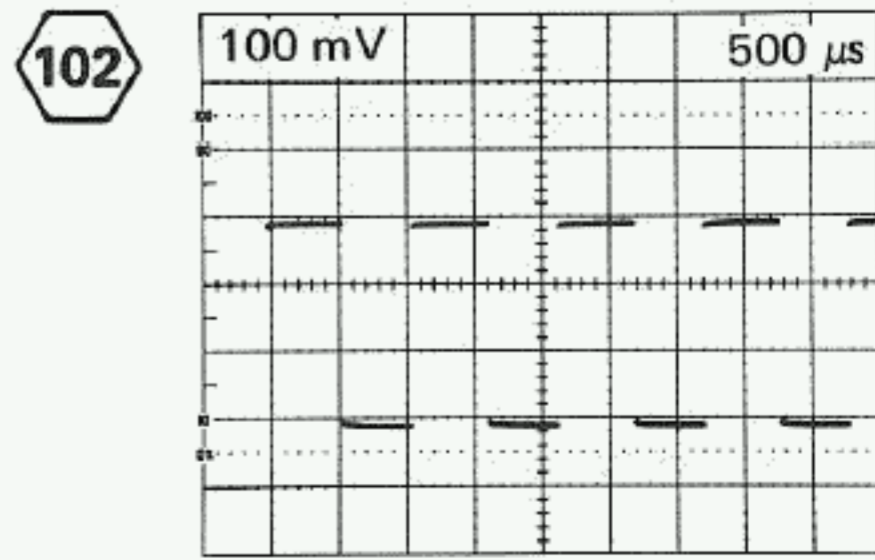
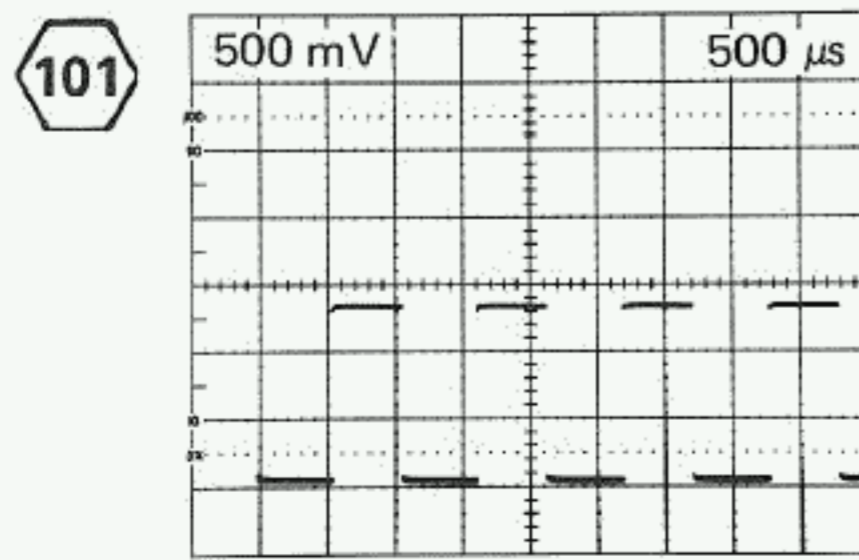
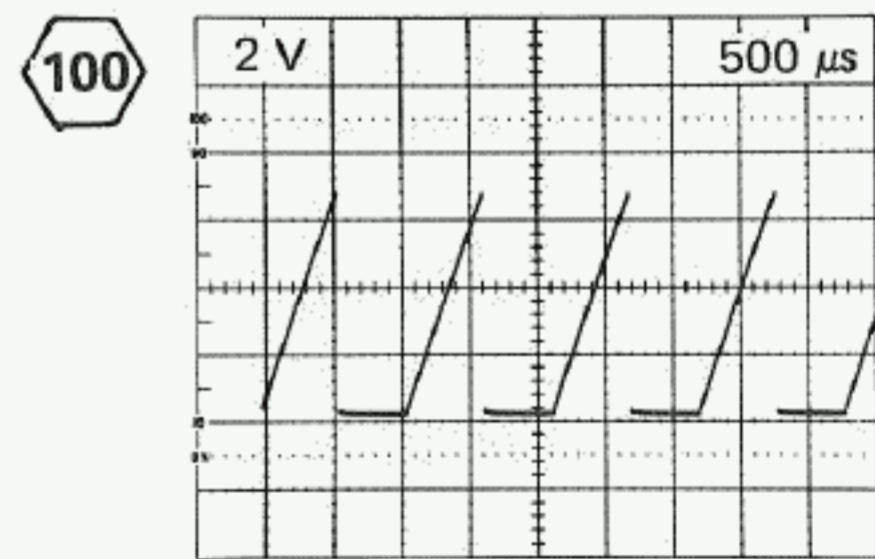
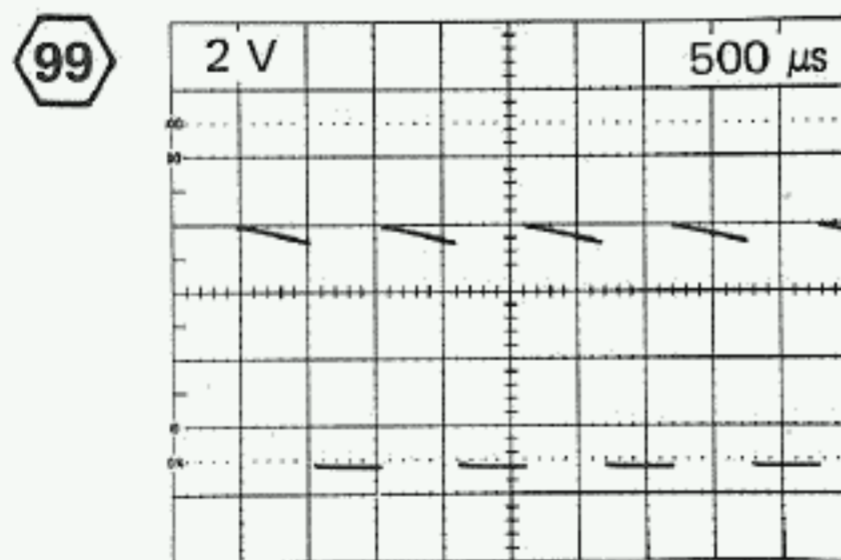
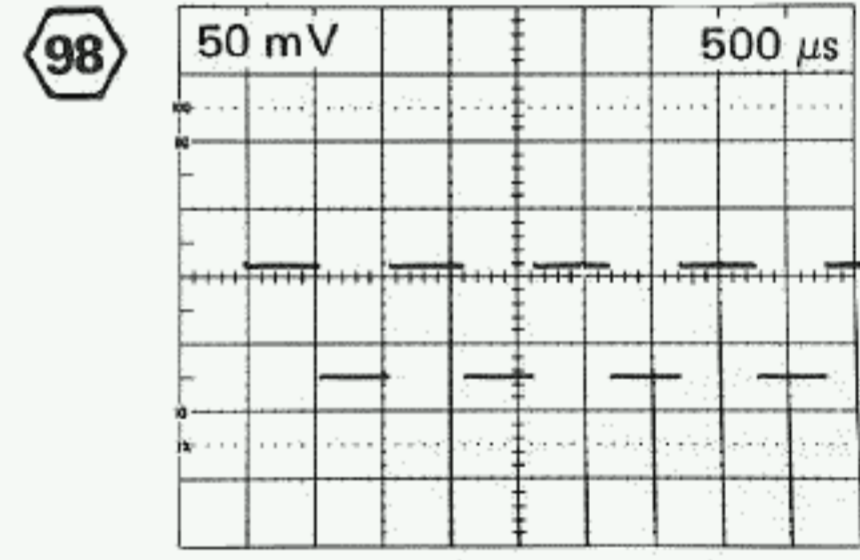
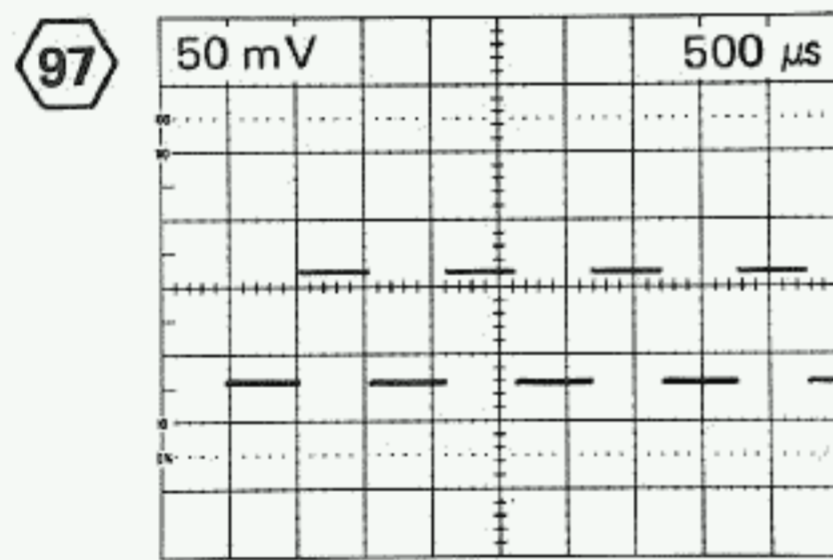
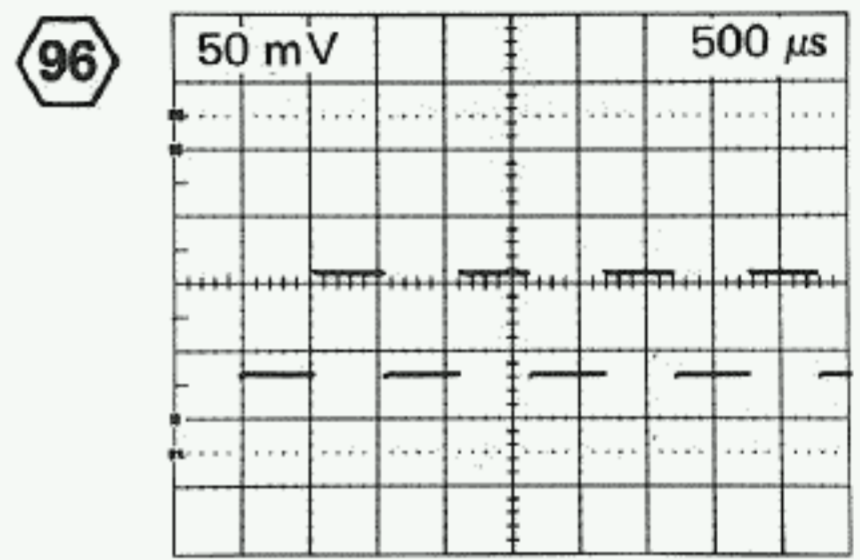
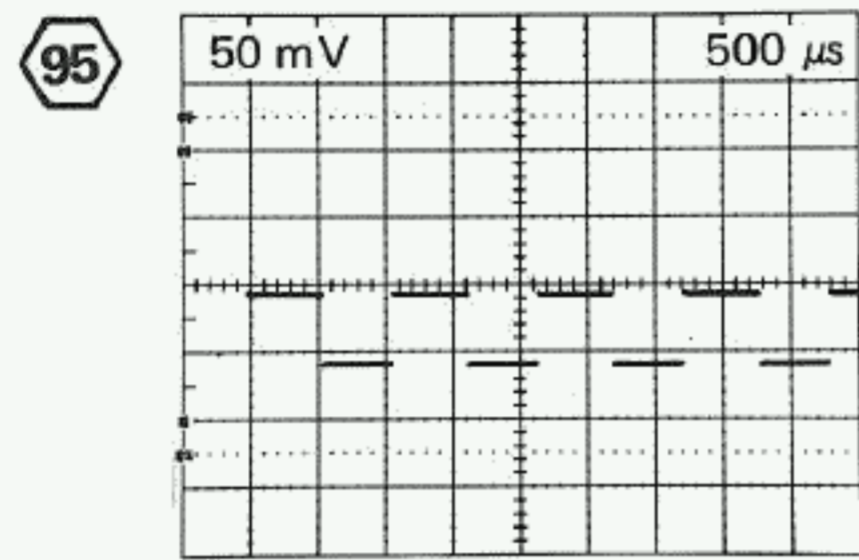
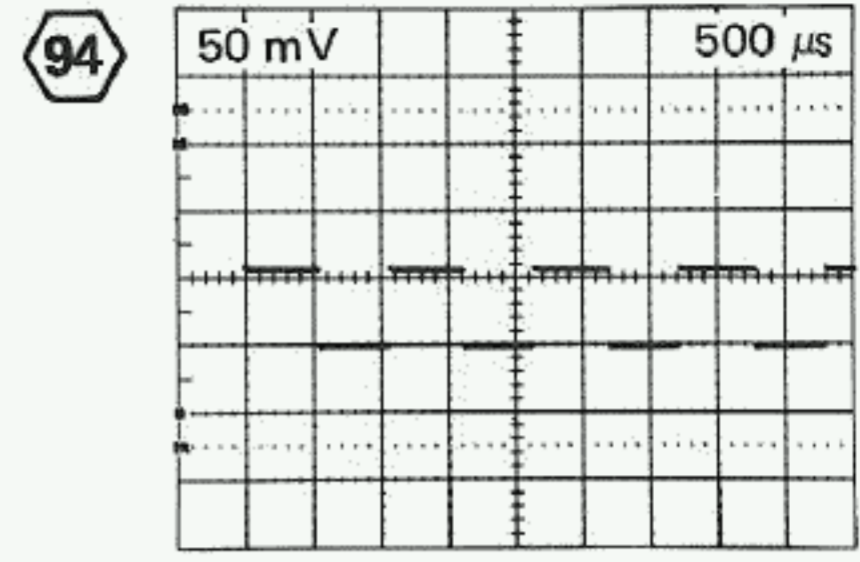
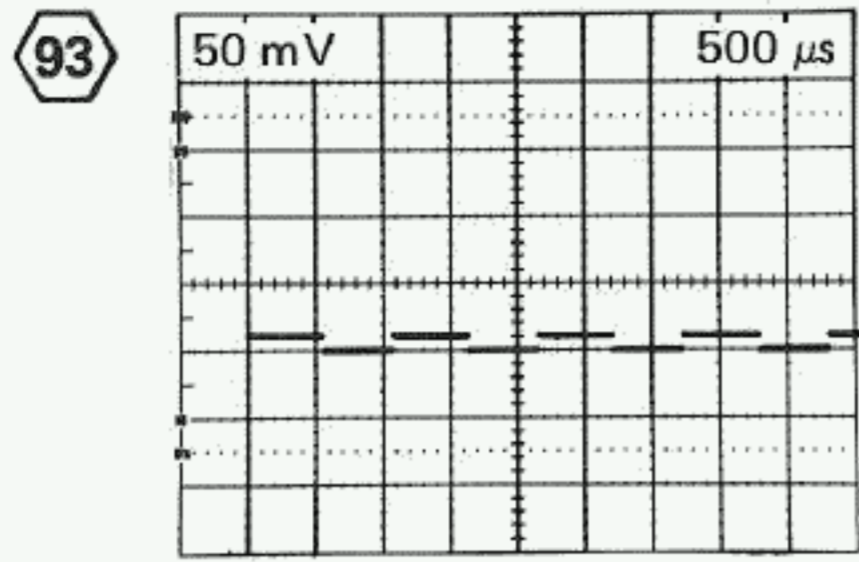

Fig. 8-17. Partial A9-Interface circuit board.
(Calibrator Components)

CKT NO	GRID LOC	CKT NO	GRID LOC	CKT NO	GRID LOC
C1249	1C	Q1570	4C	R1571	4D
C1592	3C	Q1590	3C	R1591	3C
C1593	2C	Q1594	2C	R1592	3D
C1596	2C	Q1598	2C	R1593	3C
C1597	2C			R1594	3D
		R1236	1D	R1596	2C
CR1248	1C	R1241	1D	R1597	3C
CR1596	2C	R1242	1D	R1598	3C
L1596	2C	R1244	1D	R1599	3C
		R1246	1C		
P1570	4B	R1247	1C	S400	2A
P1590	3C	R1249	1C	TP1590	2C
		R1445	2D	TP1594	2D
Q1244	1D	R1570	4D	TP GND	2C
				VR1570	4C

@

For Waveforms 93 through 98: 465 trigger-view button pushed in and held.



+

PARTIAL A9 INTERFACE BOARD

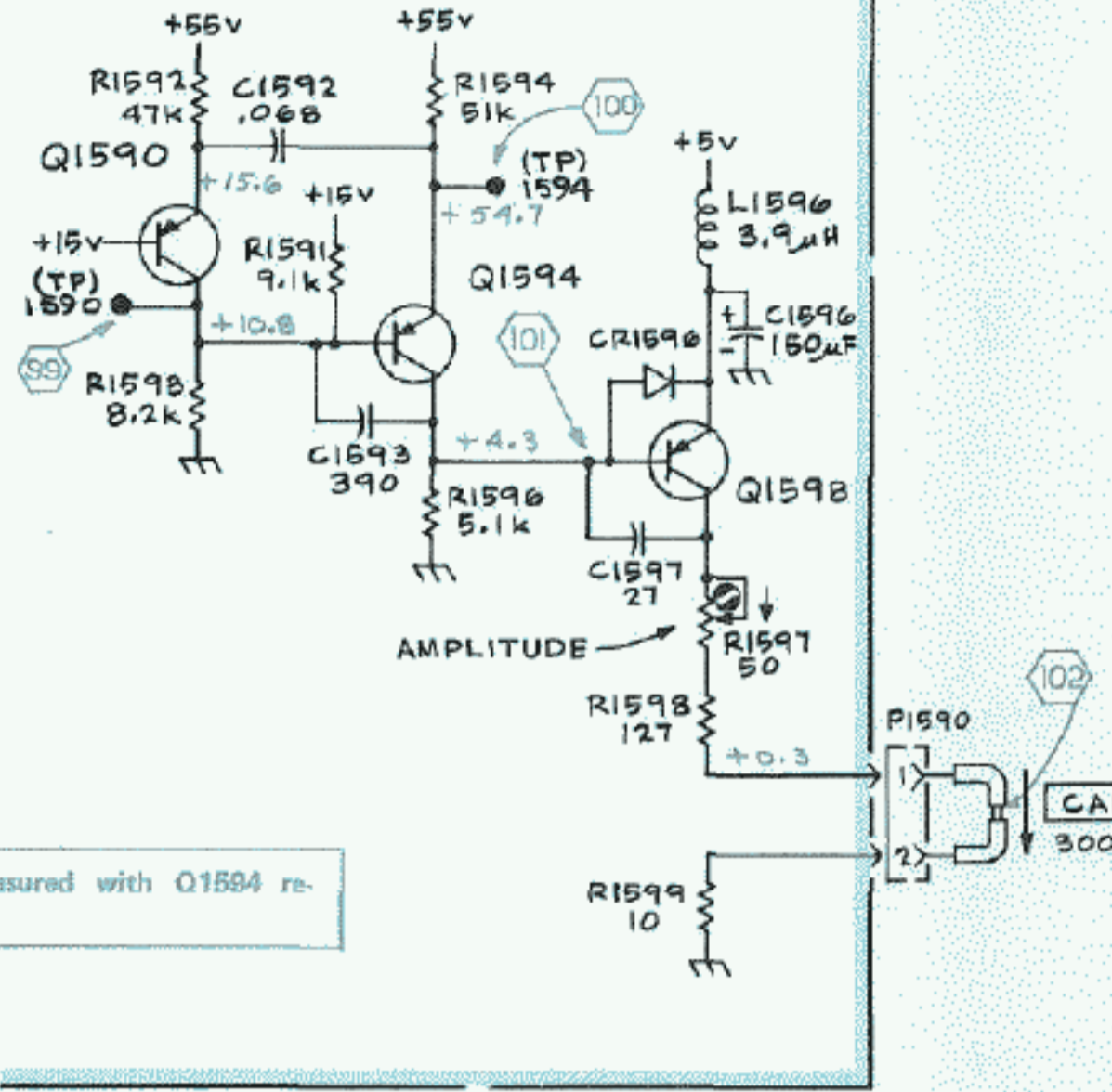

VOLTAGES MEASURED WITH Q1594 REMOVED

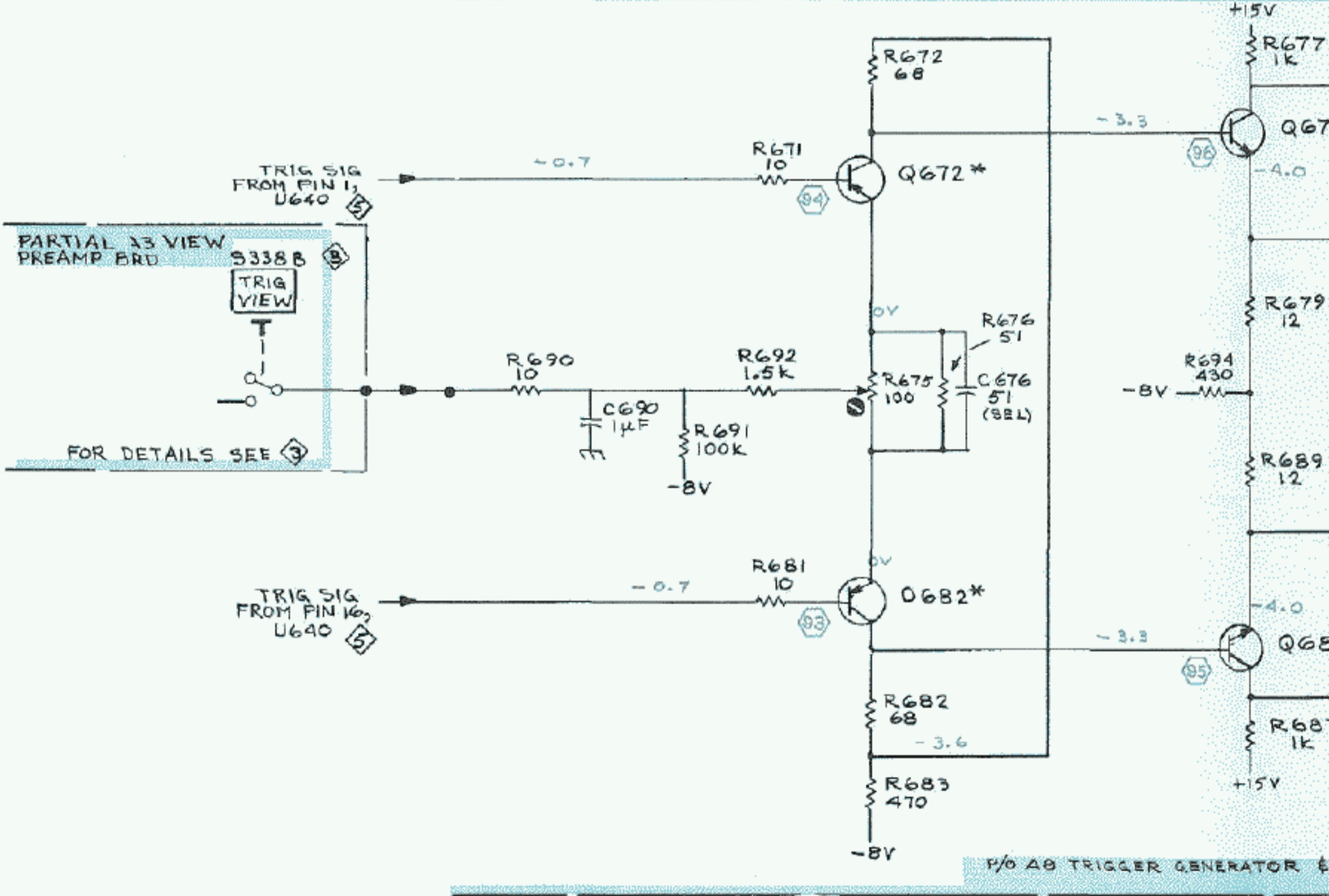

P/O A9 TRIGGER GENERATOR

* THERMAL COUPLED

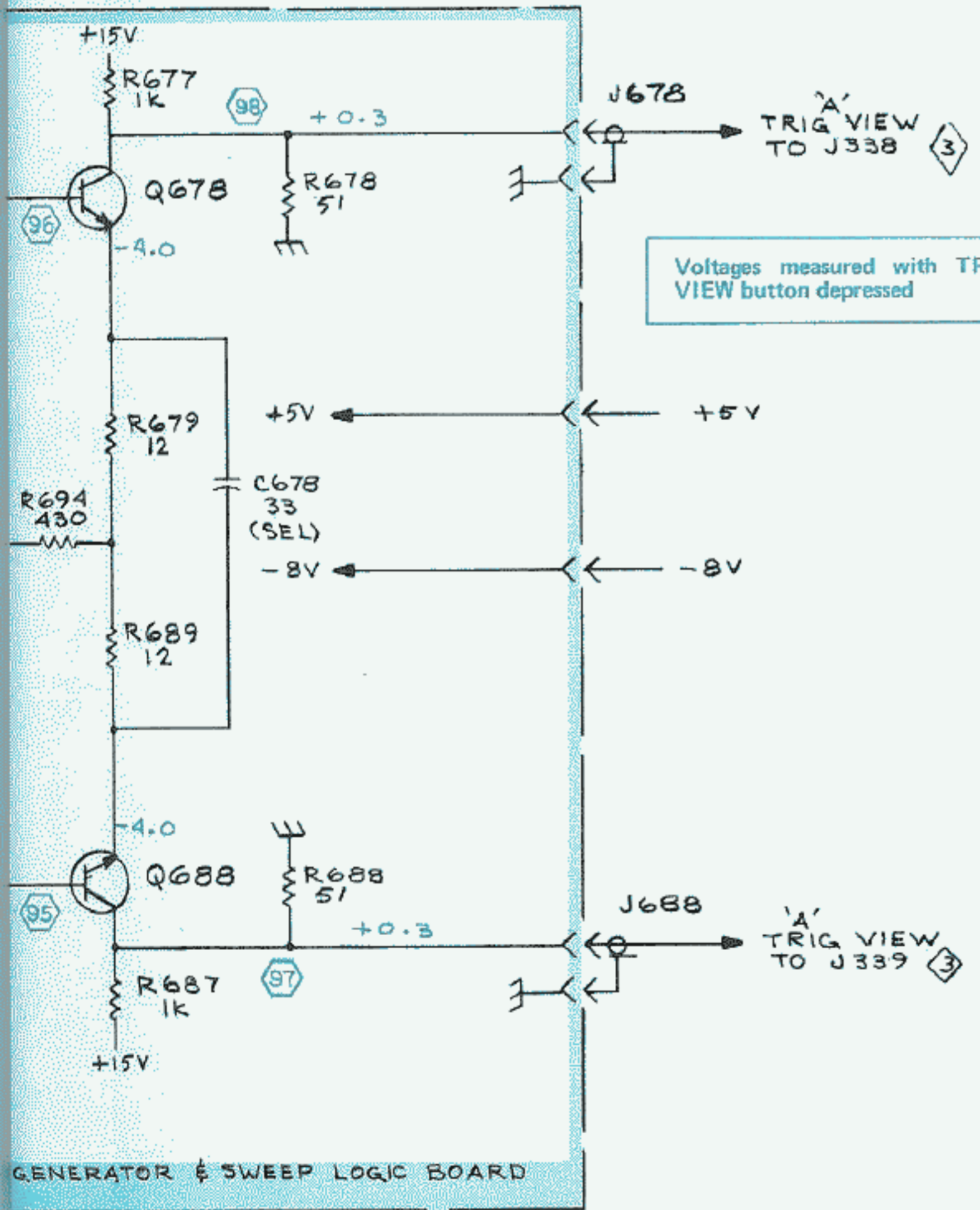
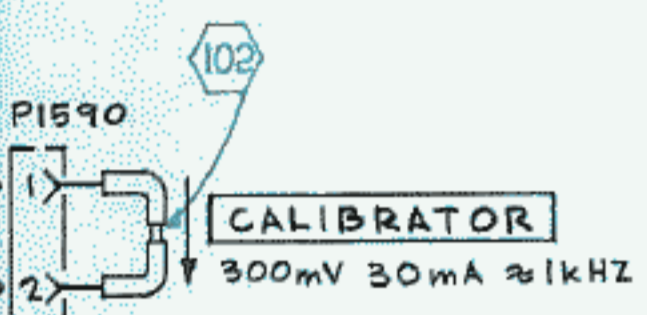
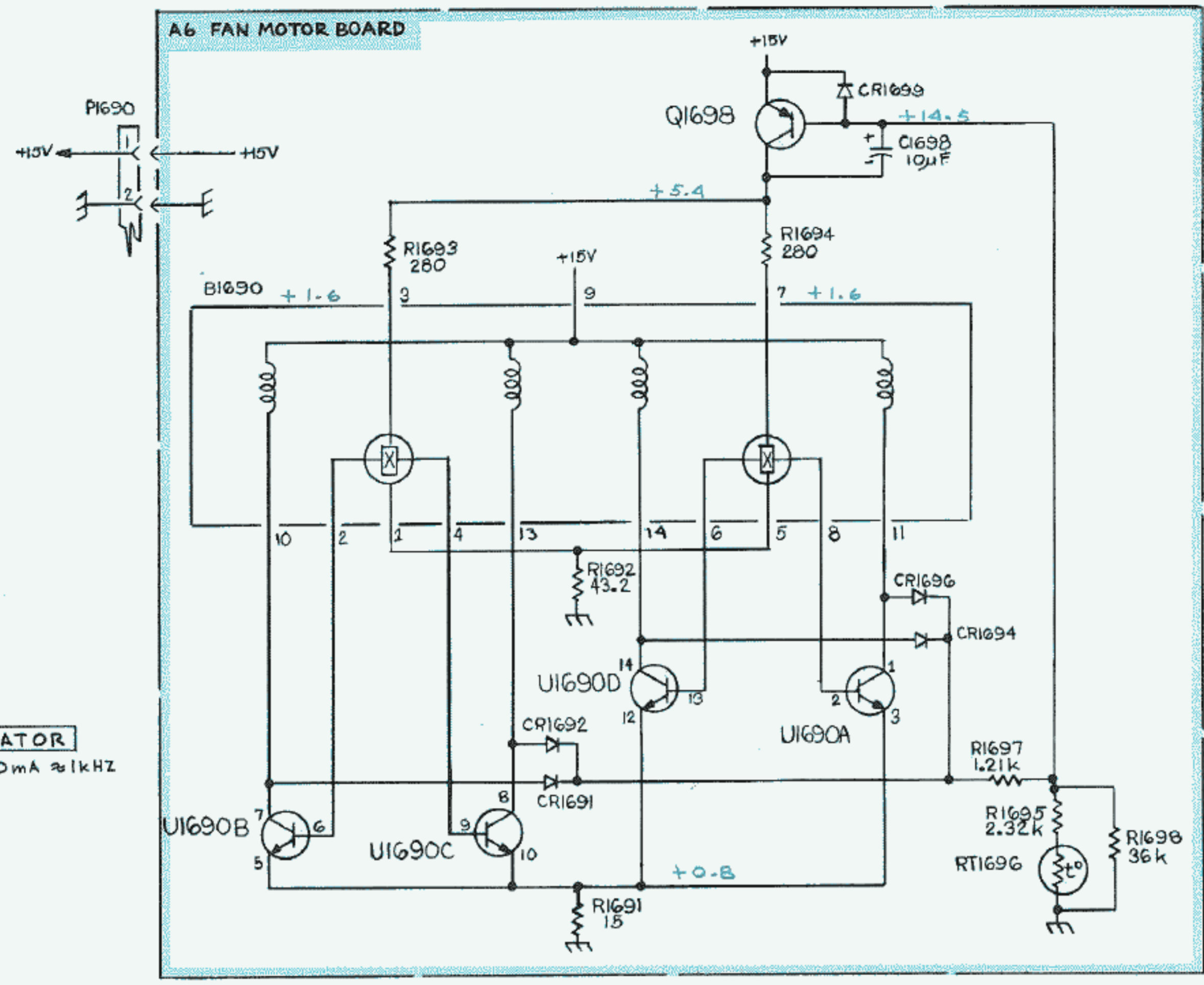

Voltages measured with TRIGGER VIEW button depressed

SEE PARTS LIST FOR EARLIER VALUES AND SERIAL NUMBER RANGES OF PARTS MARKED WITH BLUE OUTLINE.

SEE PARTS LIST FOR SEMICONDUCTOR TYPES.

1 Located on back of board
 *See parts list for serial number ranges
 2 Used only with Options 4 and 7
 3 Chassis Mounted

8 9 10 11 12

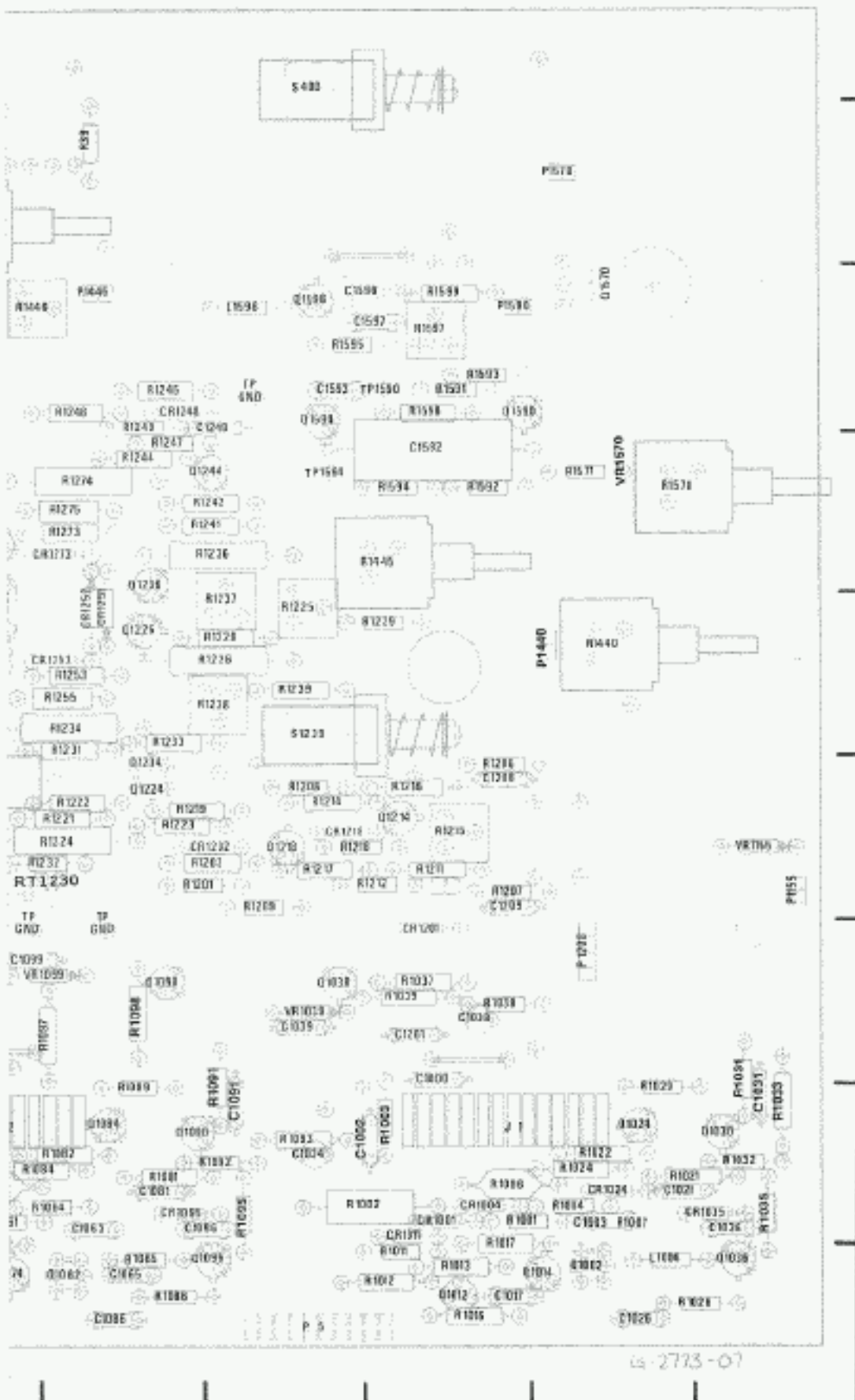

CKT NO	GRID LOC	CKT NO	GRID LOC	CKT NO	GRID LOC
C1000	10G	C1522	2F	CR1534	4G
C1002	9H	C1525	2F	CR1535	1F
C1003	11H	C1534	1F	CR1536	2F
C1017	10I	C1537	2F	CR1541	3H
C1021	11H	C1542	4H	CR1549	1G
C1024	9H	C1549	5F	CR1551	4I
C1026	11I	C1552	5H	CR1556	3F
C1031	12H	C1559	4F	CR1559	4F
C1036	12H	C1562	3G	CR1561	2G
C1038	10G	C1569	1E	CR1564	1C
C1039	9G	C1592	10D	CR1569	3H
C1038	10G	C1593	9C		
C1062	7H	C1596	9C	DS1425	3C
C1063	8H	C1597	9C	DS1426	3C
C1065	8I	C16812	1H		
C1077	7I	C16822	1H	F1419	2H
C1081	8H	C16832	2H		
C1084	6G	C16842	2I	J1	10H
C1086	8I	C16852	1H	J2	7H
C1091	9H			J3	6H
C1096	8H	CR1001	10H		
C1099	7G	CR1004	10H	L1006	11I
C1201	10G	CR1011	10H	L1419	1C
C1208	10F	CR1024	11H	L1596	9C
C1209	10F	CR1035	12H		
C1220	7F	CR1061	7H	P5	8I
C1235	7F	CR1084	7H	P6	6I
C1249	9C	CR1071	7H	P300	7B
C1256	7E	CR1095	8H	P1155	12F
C1261	7E	CR1201	10G	P1200	11G
C1262	6E	CR1202	8F	P1400	2B
C1263	6F	CR1218	9F	P1440	11E
C1269	7F	CR1248	8C	P1445	5A
C1281	7D	CR1251	8E	P1446	8C
C1282	6D	CR1252	8E	P1452	4E
C1283	7C	CR1253	8E	P1570	11B
C1288	7D	CR1266	7E	P1590	10C
C1403	4E	CR1273	8D		
C1404	4F	CR1275	7E	Q1002	11I
C1412	1B	CR1286	7D	Q1012	10I
C1416	2A	CR1404	4E	Q1014	11I
C1419	1A	CR1406	2B	Q1024	11H
C1420	2B	CR1412	1B	Q1030	12H
C1421	3B	CR1413	1B	Q1036	12I
C1422	4B	CR1414	1C	Q1038	9G
C1423	4B	CR1416	2A	Q1062	8I
C1424	4D	CR1421	3A	Q1063	6H
C1427	1B	CR1427	2C	Q1072	7I
C1430	5B	CR1461	8G	Q1074	7I
C1442	5A	CR1462	3E	Q1084	8H
C1445	5B	CR1463	5E	Q1090	8H
C1447	6B	CR1464	6G	Q1096	9I
C1449	5A	CR1465	6C	Q1098	8G
C1452	4E	CR1468	3E	Q1214	9F
C1471	3D	CR1472	3E	Q1218	9F
C1474	3E	CR1476	2D	Q1224	8F
C1475	2D	CR1482	2C	Q1226	8E
C1476	2D	CR1483	2C	Q1234	8F
C1477	2D	CR1487	3C	Q1236	8D
C1481	1C	CR1488	4C	Q1244	8D
C1484	2C	CR1511	5H	Q1254	7E
C1487	3C	CR1514	4H	Q1262	6E
C1488	3C	CR1516	6H	Q1266	6E
C1510	5I	CR1524	2F	Q1274	7D
C1511	5I	CR1532	2F	Q1282	6D
C1512	5G	CR1533	1E	Q1286	6D
C1513	4G				

45-2733-07

ard.

CKT NO	GRID LOC	CKT NO	GRID LOC	CKT NO	GRID LOC	CKT NO	GRID LOC	CKT NO	GRID LOC
CR1534	4G	Q1404	4D	R1086	8I	R1284	6C	R1519	5G
CR1535	1F	Q1408	5E	R1089	8H	R1286	6D	R1521	4G
CR1536	2F	Q1413	1B	R1091	9H	R1288	7D	R1523	2F
CR1541	3H	Q1414	1C	R1092	9H	R1289	6F	R1524	4G
CR1549	1G	Q1416	2A	R1093	9H	R1400	5F	R1525	2F
CR1551	4I	Q1418 ³		R1095	9H	R1401	4E	R1527	2F
CR1556	3F	Q1466	3E	R1097	8G	R1402	5E	R1528	4F
CR1559	4F	Q1472	3E	R1098	8G	R1403	5E	R1532	1E
CR1561	2G	Q1474	2D	R1201	8F	R1404	4E	R1533	2E
CR1564	1C	Q1478	2D	R1202	8F	R1406	5E	R1534	1F
CR1569	3H	Q1516	4H	R1206	10F	R1407	5D	R1537	2F
		Q1518	5G	R1207	10F	R1408	4F	R1538	2F
DS1425	3C	Q1532	1E	R1208	9F	R1409	2A	R1539	2G
DS1426	3C	Q1534	1E	R1209	9F	R1411	1B	R1543	2G
		Q1536	2E	R1211	10F	R1412	1B	R1544	2G
F1419	2H	Q1544	1G	R1212	10F	R1413	1B	R1546	1G
		Q1546	1F	R1215	10F	R1414	1B	R1547	2G
J1	10H	Q1548	1G	R1216	10F	R1416	1B	R1549	1G
J2	7H	Q1556	3F	R1217	9F	R1420	2C	R1553	1E
J3	6H	Q1558	3F	R1218	9F	R1421	4B	R1554	1E
		Q1564	1D	R1219	8F	R1422	4C	R1556	3F
L1006	11I	Q1566	1D	R1220	7F	R1423	4C	R1557	2F
L1419	1C	Q1568	1D	R1221	8F	R1427	1B	R1559	3F
L1596	9C	Q1570	11C	R1222	8F	R1428	2B	R1563	1E
		Q1590	10C	R1223	8F	R1430	5C	R1564	2E
P5	9I	Q1594	9C	R1224	8F	R1431	4D	R1565	2E
P6	6I	Q1598	9C	R1225	9E	R1434	7B	R1566	1D
P300	7B			R1226	9E	R1440	11E	R1567	1D
P1155	12F	R39	8B	R1228	9E	R1442	7C	R1569	1D
P1200	11G	R1001	10H	R1229	9E	R1445	10D	R1570	11D
P1400	2B	R1002	9H	R1231	8E	R1446	7C	R1571	11D
P1440	11E	R1003	10H	R1232	8F	R1447	6A	R1591	10C
P1445	5A	R1004	11H	R1233	8E	R1448	6A	R1592	10D
P1446	8C	R1006	10H	R1234	8E	R1449	6A	R1593	10C
P1452	4E	R1007	11H	R1235	7G	R1451	4E	R1594	10D
P1570	11B	R1011	10I	R1236	8D	R1452	4E	R1595	9C
P1590	10C	R1012	10I	R1237	8E	R1453	4E	R1597	10C
		R1013	10I	R1238	9E	R1460	7B	R1598	10C
Q1002	11I	R1016	10I	R1239	9E	R1461	6G	R1599	10C
Q1012	10I	R1017	10H	R1241	8D	R1462	4D	RT1230	8F
Q1014	11I	R1021	11H	R1242	8D	R1463	6C	S400	9A
Q1024	11H	R1022	11H	R1244	8D	R1464	4F	S1239	9E
Q1030	12H	R1024	11H	R1246	8C	R1466	4E	†T1420	2A
Q1036	12I	R1026	11I	R1247	8D	R1467	4E	TP1486	3D
Q1038	9G	R1029	11H	R1248	8D	R1468	3E	TP1518	6F
Q1062	8I	R1031	12H	R1249	8C	R1469	3D	TP1536	5F
Q1063	6H	R1032	12H	R1253	8E	R1470	3E	TP1548	5F
Q1072	7I	R1033	12H	R1254	6F	R1471	4E	TP1558	5F
Q1074	7I	R1035	12H	R1255	8E	R1472	3E	TP1568	5F
Q1084	8H	R1037	10G	R1260	7E	R1473	3E	TP1590	10C
Q1090	8H	R1038	10G	R1261	6E	R1474	3E	TP1594	9D
Q1096	9I	R1039	10G	R1262	6F	R1475	2D		
Q1098	8G	R1061	7H	R1263	6F	R1476	2D	†U1432	5B
Q1214	9F	R1062	6H	R1264	6F	R1477	3E	U1524	2G
Q1218	9F	R1063	7H	R1266	6E	R1478	3D	U1554	1E
Q1224	8F	R1064	8H	R1268	7F	R1480	2D		
Q1226	8E	R1065	8I	R1269	6F	R1481	2C	VR1039	9G
Q1234	8F	R1066	7H	R1273	8D	R1482	3C	VR1099	7G
Q1236	8D	R1071	6I	R1274	8D	R1484	2C	VR1155	12F
Q1244	8D	R1072	6I	R1275	8D	R1485	3D	VR1289	6F
Q1254	7E	R1073	7I	R1280	6D	R1486	4C	VR1428	2B
Q1262	6E	R1076	7I	R1281	7D	R1488	2C	VR1484	2C
Q1266	6E	R1077	7H	R1282	6C	R1510	5I	VR1515	4G
Q1274	7D	R1081	8H	R1283	6D	R1511	4I	VR1522	3G
Q1282	6D	R1082	8H			R1516	4H	VR1525	1F
Q1286	6D	R1084	8H			R1517	6G	VR1526	2G
						R1518	5H	VR1533	3F
								VR1570	11C

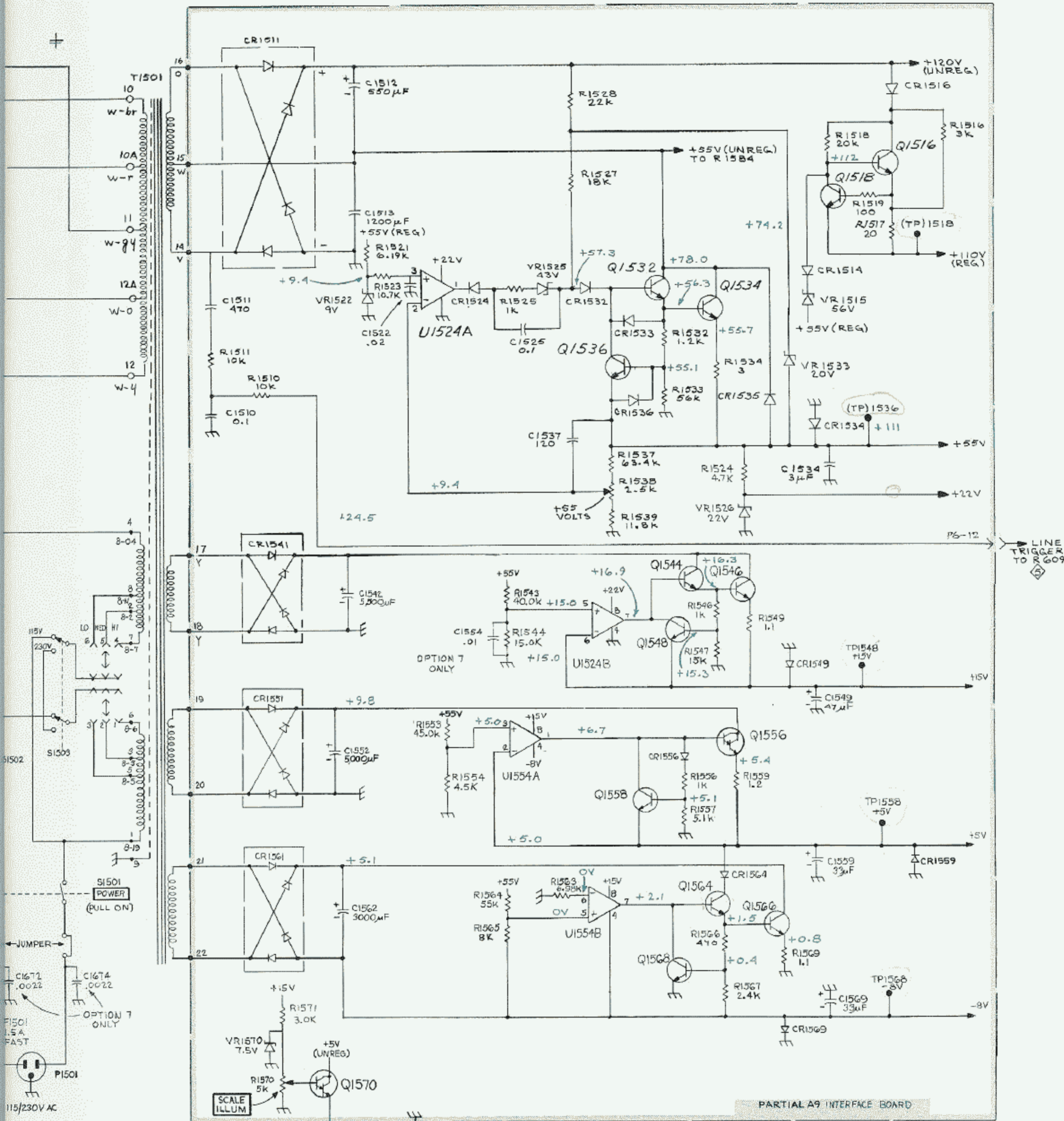

SEE PARTS LIST FOR EARLIER VALUES AND SERIAL NUMBER RANGES OF PARTS MARKED WITH BLUE OUTLINE.

SEE PARTS LIST FOR SEMICONDUCTOR TYPES.

Voltages measured with line set at 123 V RMS medium range

SEE FIG. 8-12 FOR COMPONENT LOCATION

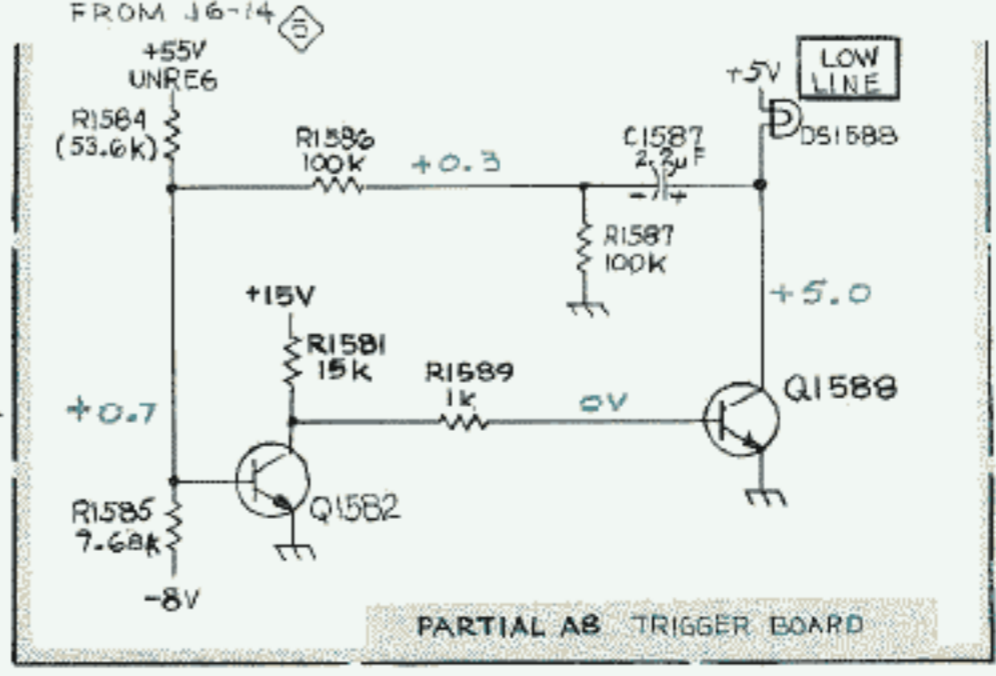

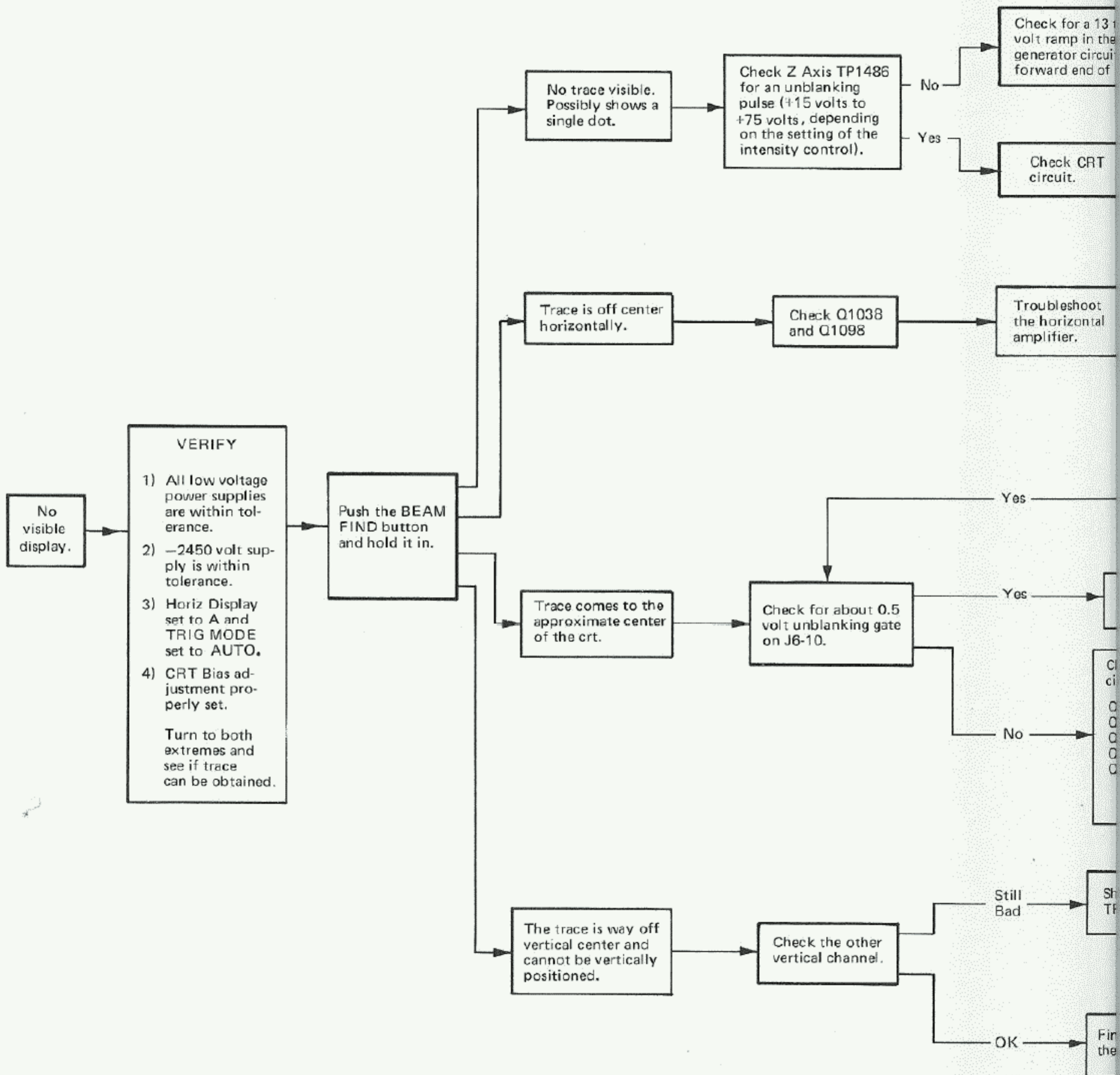

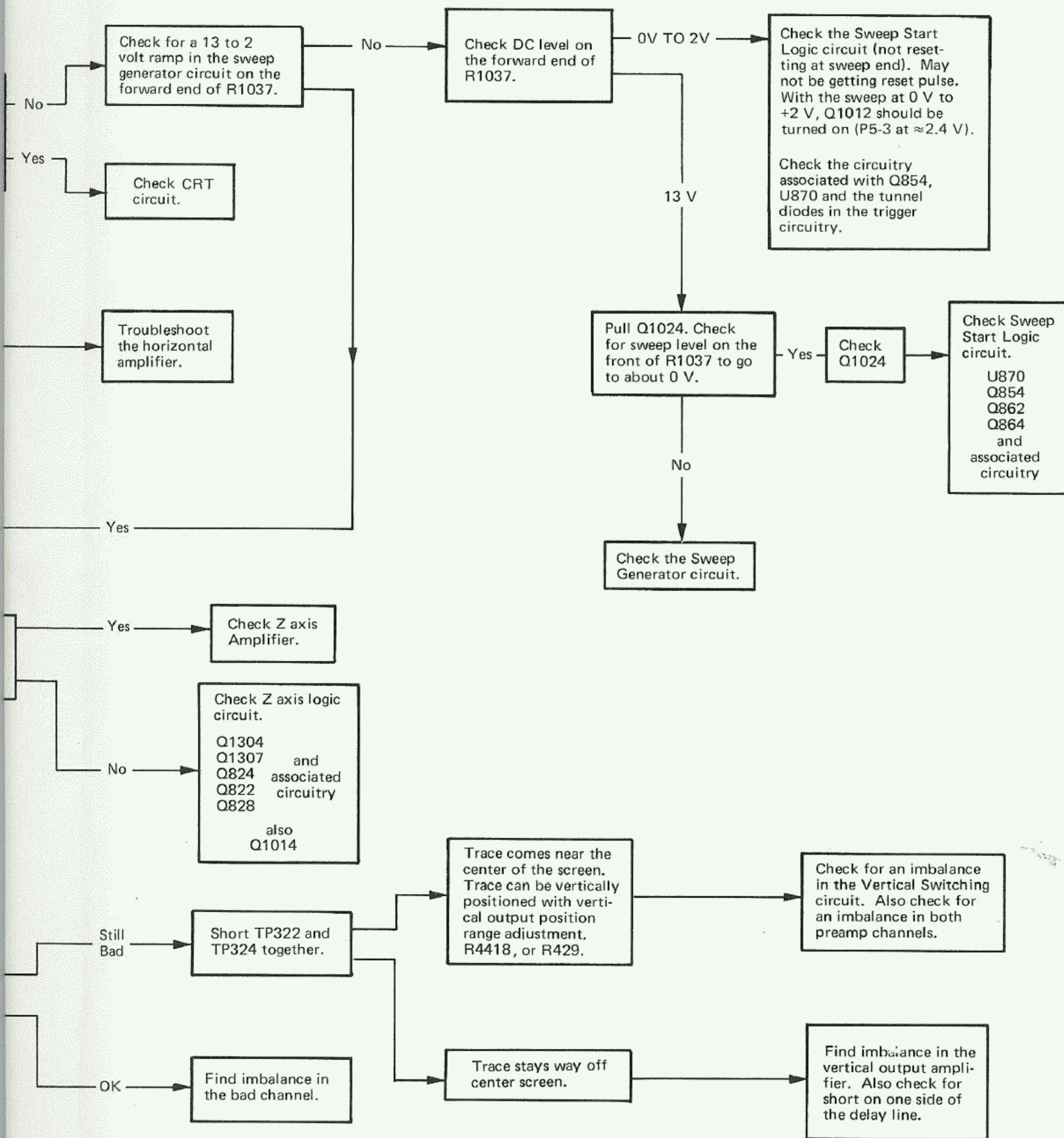

REV. A, JUNE, 1975

NO VISIBLE DISPLAY
TROUBLESHOOTING

POWER SUPPLY ISOLATION PROCEDURE

The following procedure is used as an aid in localizing the area in which loading of a power supply occurs. If the power supply comes up after isolating a circuit, it is very probable the problem is in that circuit. This can sometimes, however, lead to erroneous conclusions as a supply may pass through one circuit to another circuit. For instance, the +5 volt supply enters the timing board through P2-5. It then passes through the timing switch (in the X-Y position only) and P1-10 to CR1202 in the horizontal amplifier circuit. From P1-10 it also passes through P5-4 to the sweep control IC on the trigger board. Watch for these types of conditions when trying to localize a loading problem.

+55 Volt Supply

1. Pull P300 from the Interface board. This isolates the Vertical Preamp board.
2. Unsolder the dummy resistor near J-1. See adjustment locations 1 . This isolates the Timing board.
3. Pull P1155 from the front of the Interface board. This isolates the holdoff circuit.
4. To isolate the Trigger board from the +55 volt supply it is necessary to remove the Trigger board from the instrument. The +55 volt supply connects to the Trigger board through P5-2. The +55 volt unregulated supply connects to the Trigger board through P5-2.



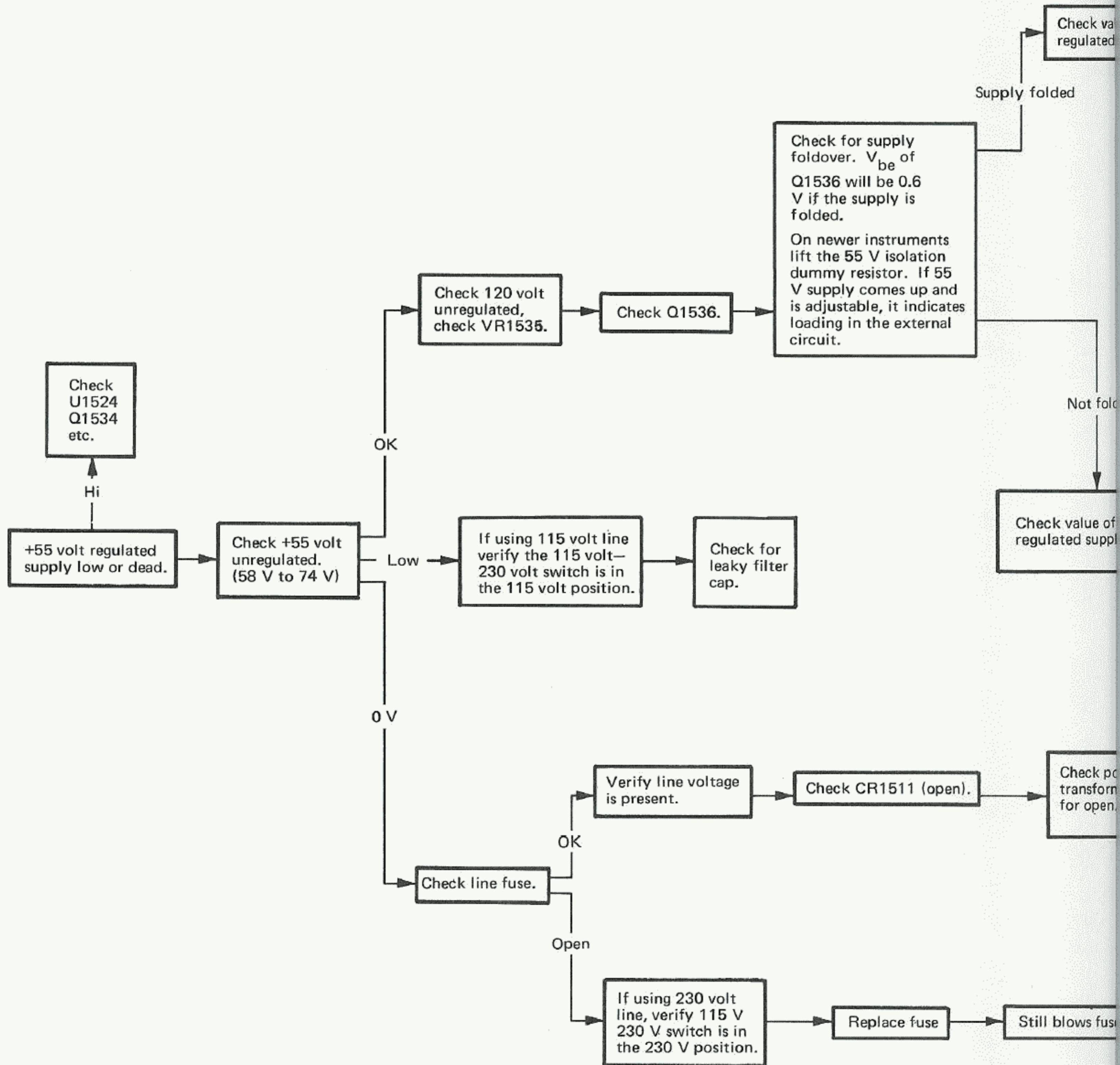

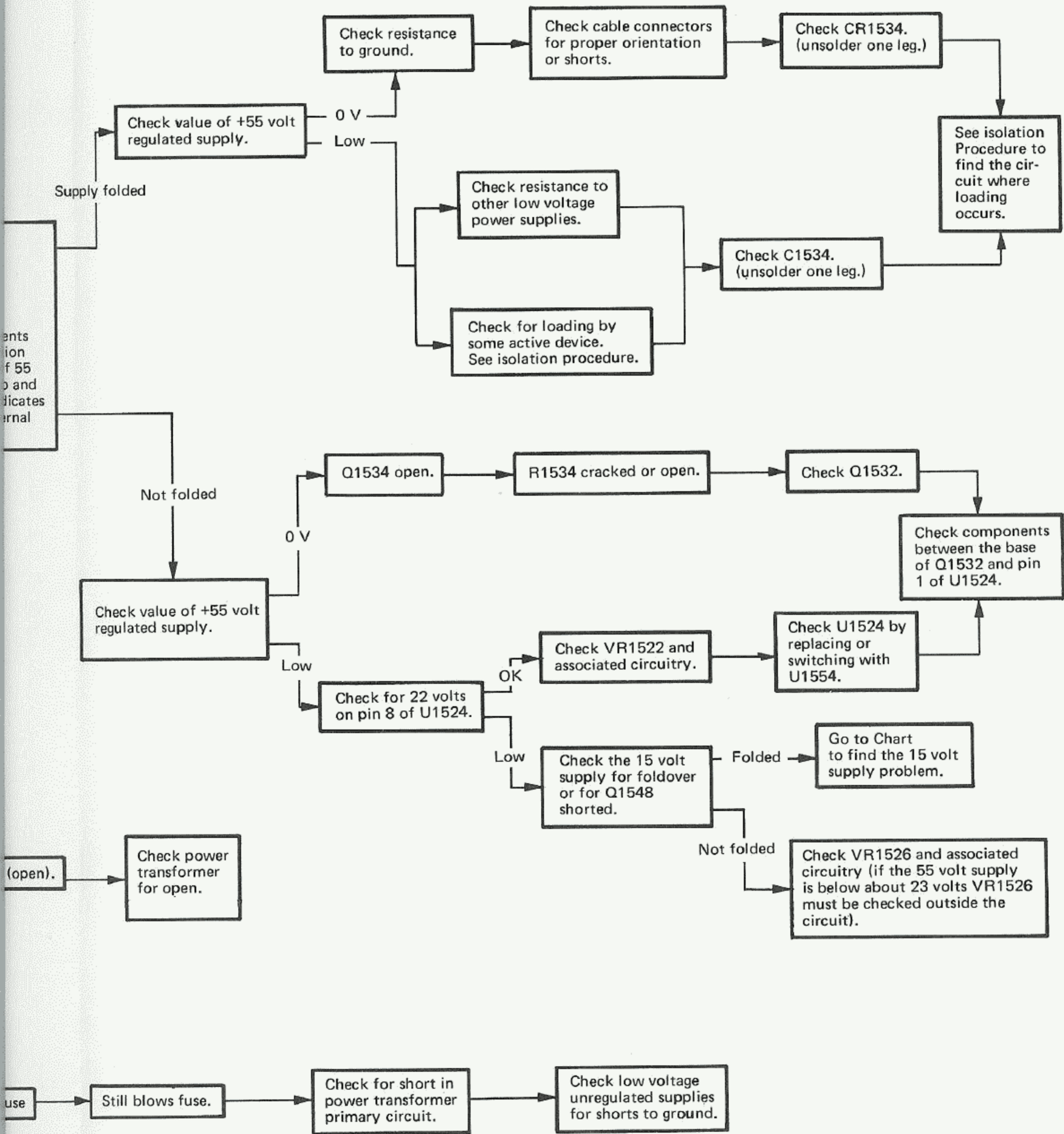

@

POWER SUPPLY ISOLATION PROCEDURE

The following procedure is used as an aid in localizing the area in which loading of a power supply occurs. If the power supply comes up after isolating a circuit, it is very probable the problem is in that circuit. This can sometimes, however, lead to erroneous conclusions as a supply may pass through one circuit to another circuit. For instance, the +5 volt supply enters the timing board through P2-5. It then passes through the timing switch (in the X-Y position only) and P1-10 to CR1202 in the horizontal amplifier circuit. From P1-10 it also passes through P5-4 to the sweep control IC on the trigger board. Watch for these types of conditions when trying to localize a loading problem.

+15 Volt Supply

1. Pull P300 from the Interface board. This isolates the Vertical Preamplifier board.
2. Unsolder the dummy resistor near J2. See adjustment locations 1 . This isolates the Timing board.
3. Unsolder L891 at the rear of the Trigger board. See adjustment locations 1 . This isolates most of the Trigger board. Also unsolder VR896 from the rear of the Trigger board. See adjustment locations 1 . This isolates the +8 volt supply.
4. Pull P1690 from the Fan Motor board. This isolates the fan motor circuit.
5. Pull P400 from the Vertical Output Amplifier board. This isolates the Vertical Output Amplifier board.
6. Pull P1200 from the Interface board. See adjustment locations 1 . This isolates the Horizontal Position and Fine controls.

+5 Volt Supply

1. Pull P300 from the Interface board. This isolates the Vertical Preamplifier board.
2. Unsolder the dummy resistor near J-2. See adjustment locations 1 . This isolates the Timing board.
3. Unsolder L893 from the rear of the Trigger board. See adjustment locations 1 . This isolates the Trigger board.
4. Pull P1155 from the Interface board. See adjustment locations 1 . This isolates the holdoff circuitry.
5. Unsolder L1596 from the Interface board. See adjustment locations 1 . This isolates the calibrator circuitry.

-8 Volt Supply

1. Unsolder one end of R1445, R1476, and CR1476. See adjustment locations 1 . This isolates the CRT circuit (Z-Axis amplifier).
2. Unsolder one end of VR1289, R1282, R1262, R1229. See adjustment locations 1 . This isolates the horizontal amplifier circuit.



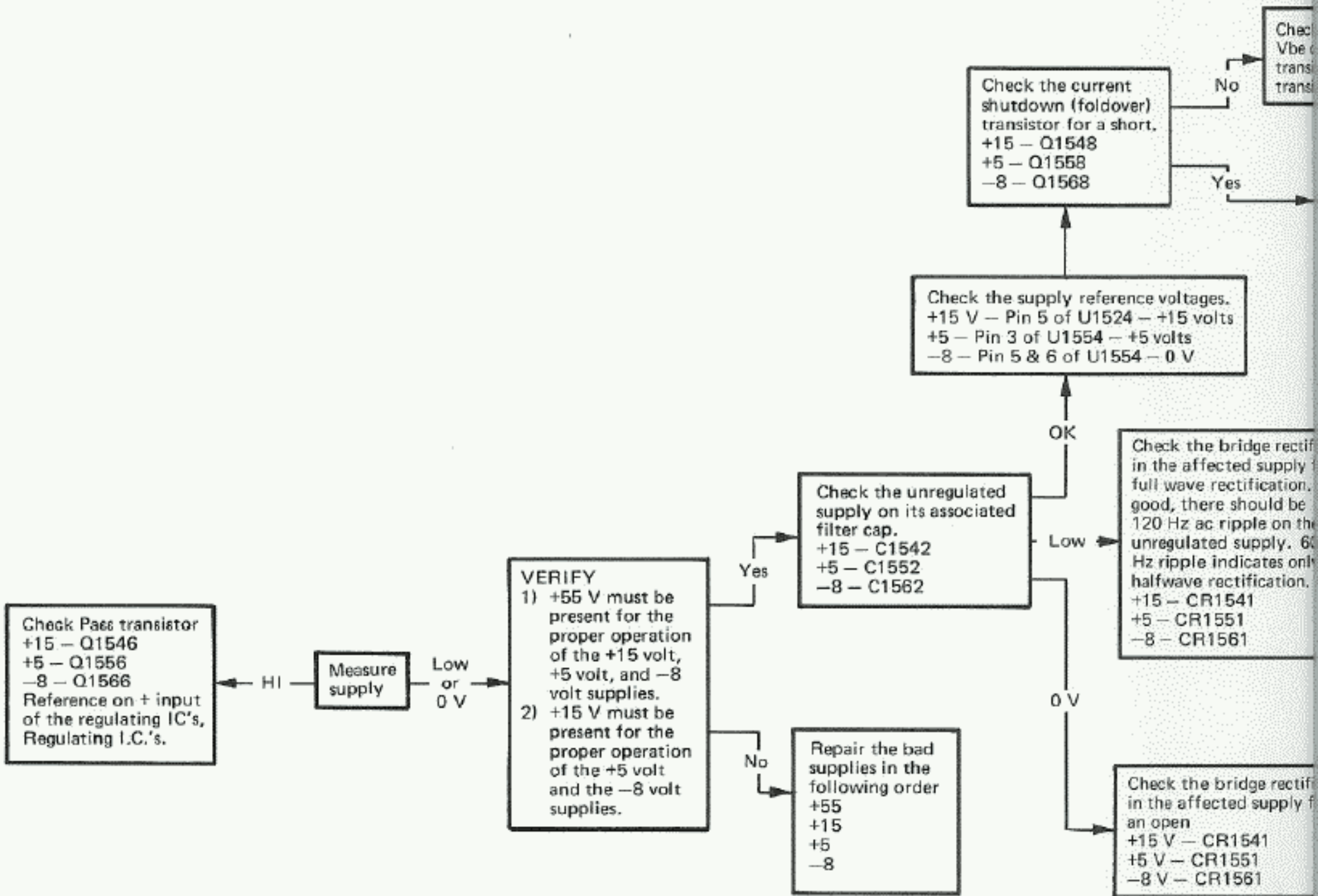

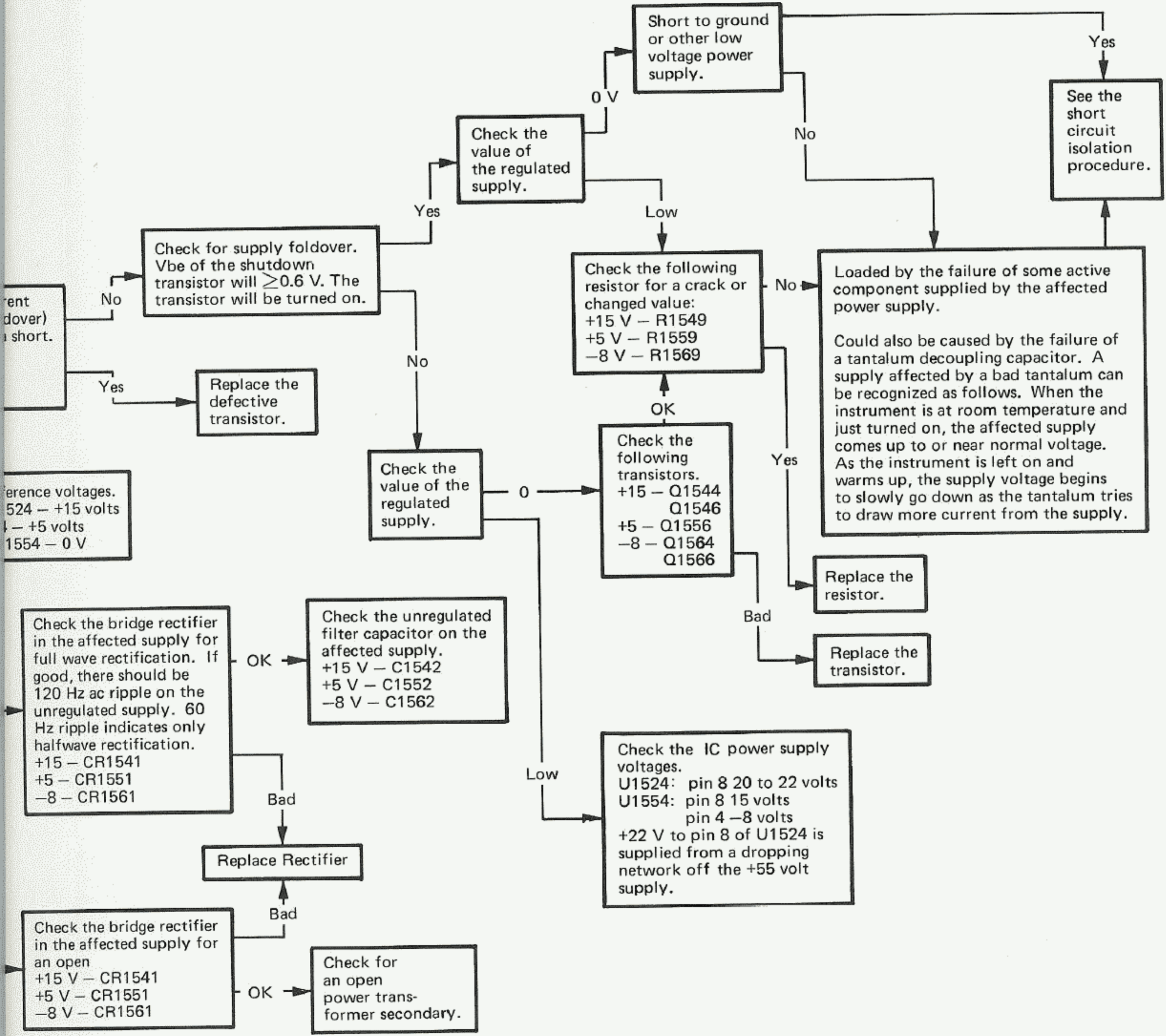

ent
dover)
short.

reference voltages.
U1524 - +15 volts
U1554 - +5 volts
U1554 - 0 V

@

110 VOLT SUPPLY ISOLATION PROCEDURE

The following procedure is used as an aid in localizing the area in which loading of a power supply occurs. If the power supply comes up after isolating a circuit, it is very probable the problem is in that circuit. This can sometimes, however, lead to erroneous conclusions as a supply may pass through one circuit to another circuit. For instance, the +5 volt supply enters the timing board through P2-5. It then passes through the timing switch (in the X-Y position only) and P1-10 to CR1202 in the horizontal amplifier circuit. From P1-10 it also passes through P5-4 to the sweep control IC on the trigger board. Watch for these types of conditions when trying to localize a loading problem.

1. Unsolder one end of R1445, R1476, and CR1476. See adjustment locations 1 . This isolates the CRT circuit (Z-Axis amplifier).
2. Unsolder one end of VR1289, R1282, R1262, R1229. See adjustment locations 1 . This isolates the horizontal amplifier circuit.



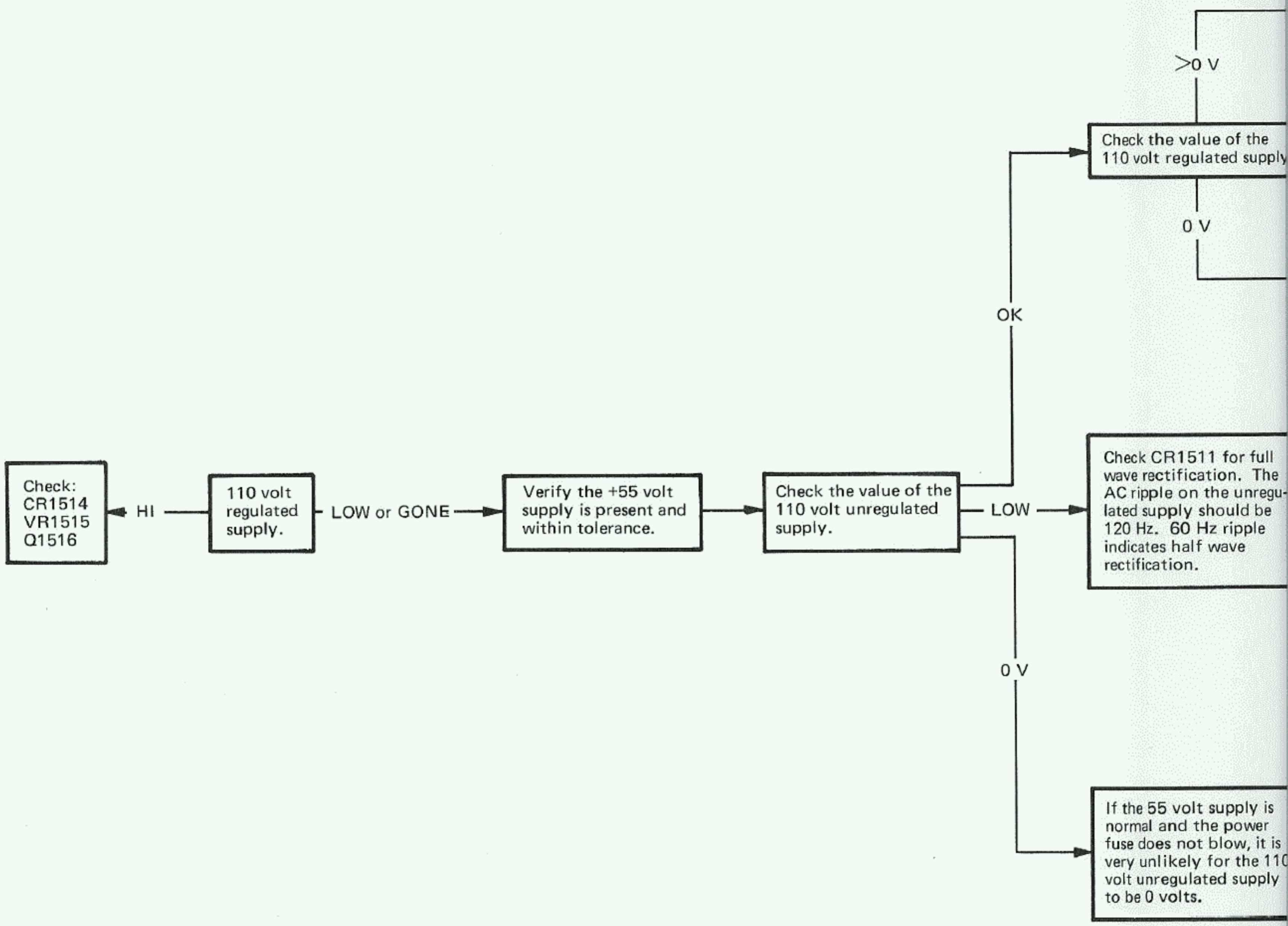

>0 V

Check the value of the 110 volt regulated supply

0 V

OK

Check:
CR1514
VR1515
Q1516

HI

110 volt regulated supply.

LOW or GONE

Verify the +55 volt supply is present and within tolerance.

Check the value of the 110 volt unregulated supply.

LOW

Check CR1511 for full wave rectification. The AC ripple on the unregulated supply should be 120 Hz. 60 Hz ripple indicates half wave rectification.

0 V

If the 55 volt supply is normal and the power fuse does not blow, it is very unlikely for the 110 volt unregulated supply to be 0 volts.

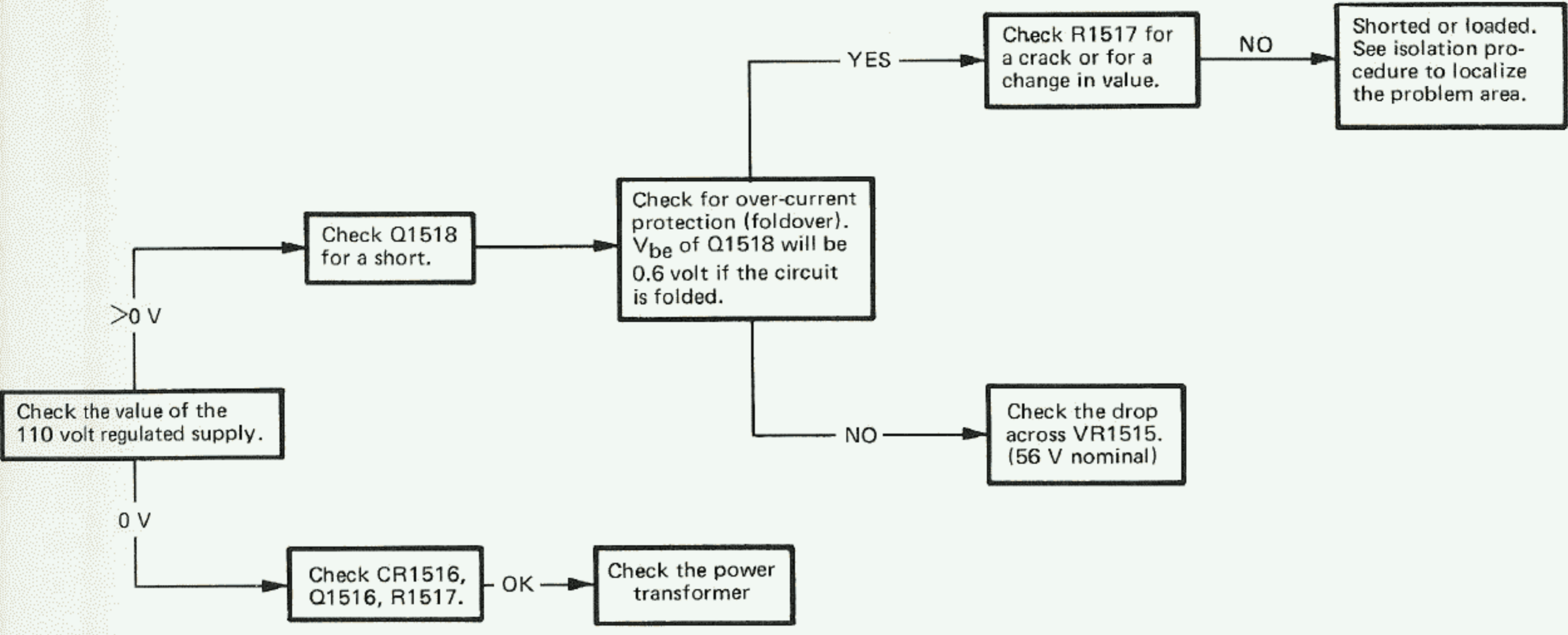

Check CR1511 for full wave rectification. The AC ripple on the unregulated supply should be 120 Hz. 60 Hz ripple indicates half wave rectification.

If the 55 volt supply is normal and the power fuse does not blow, it is very unlikely for the 110 volt unregulated supply to be 0 volts.

@

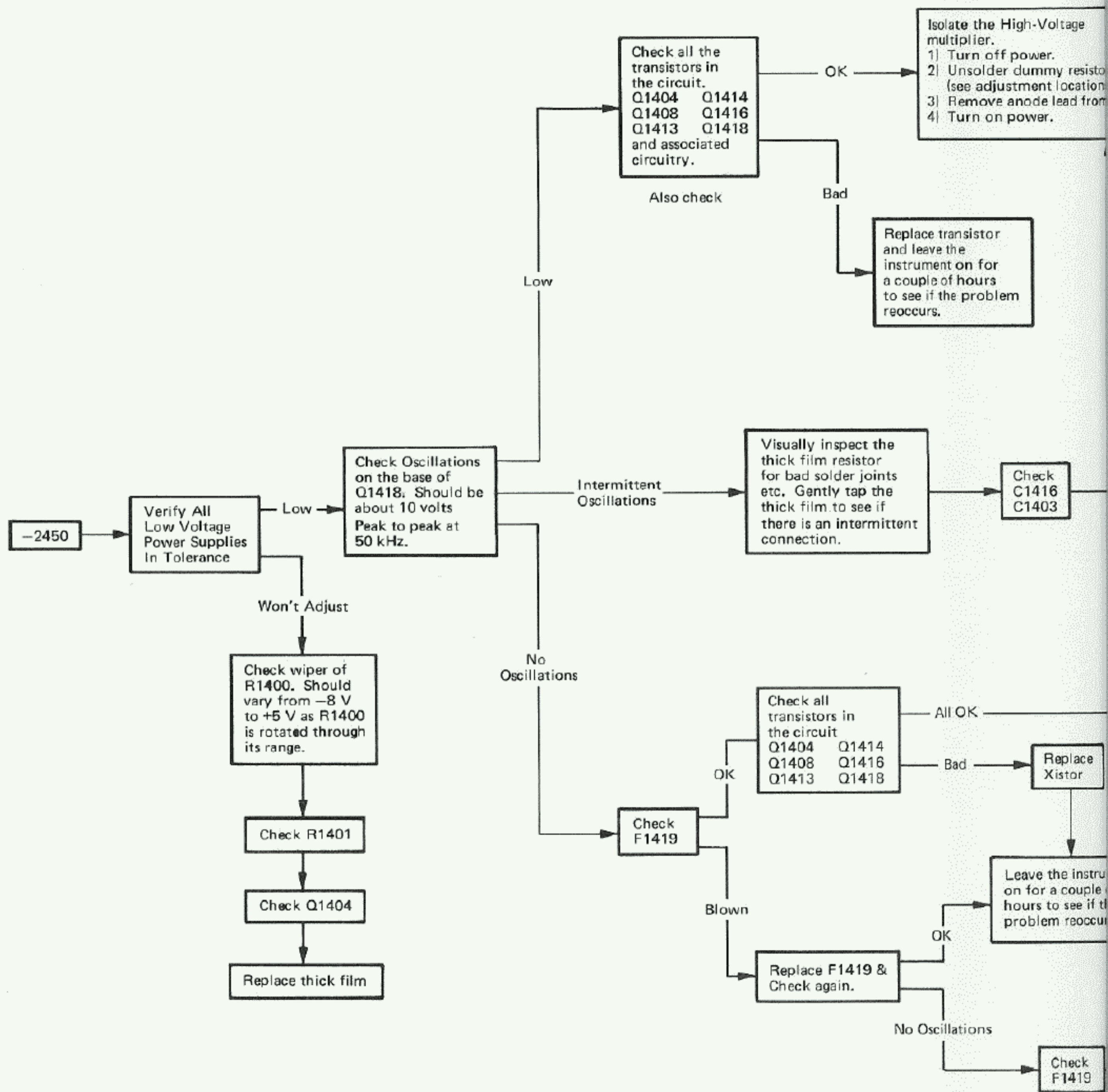

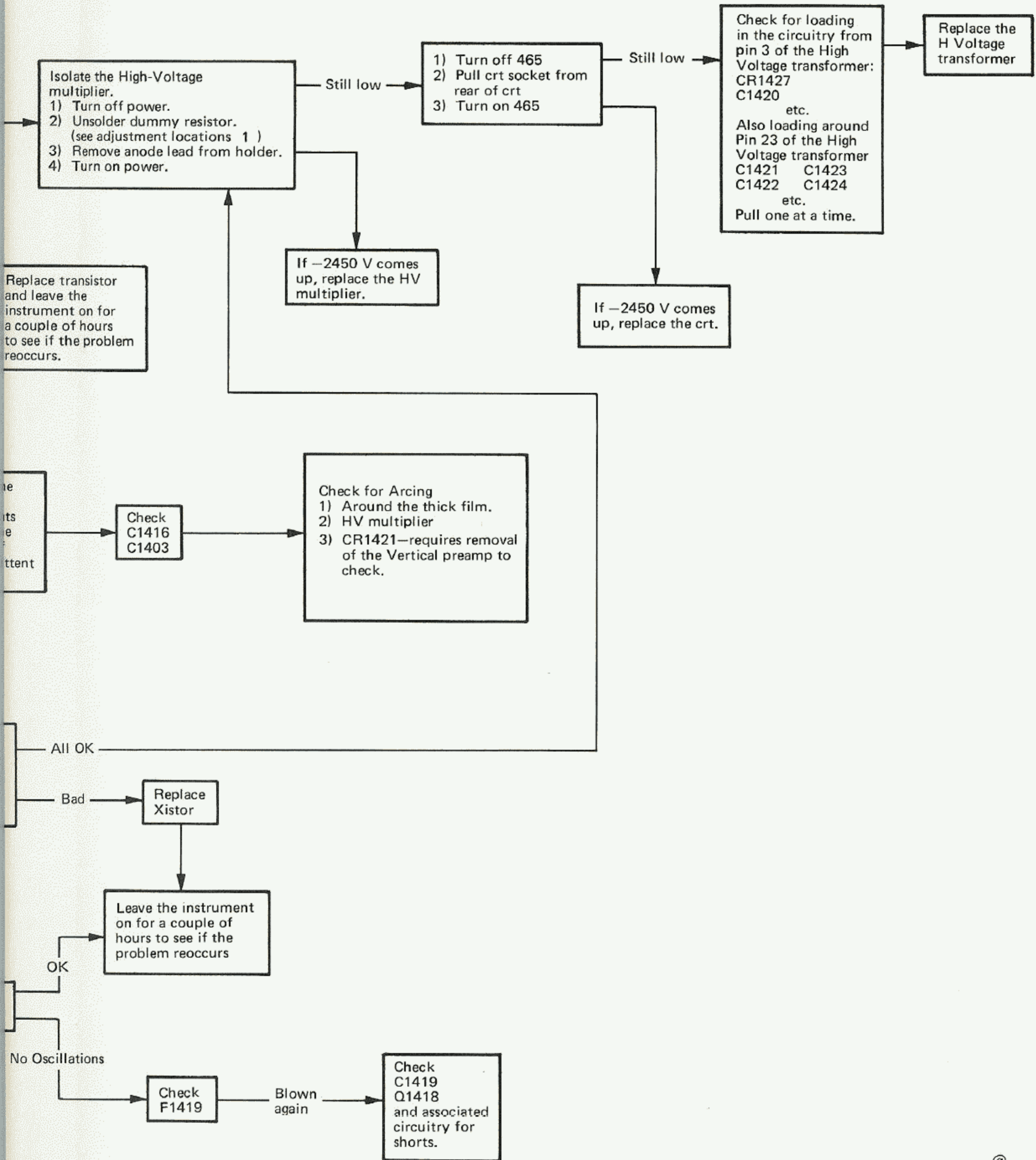

@

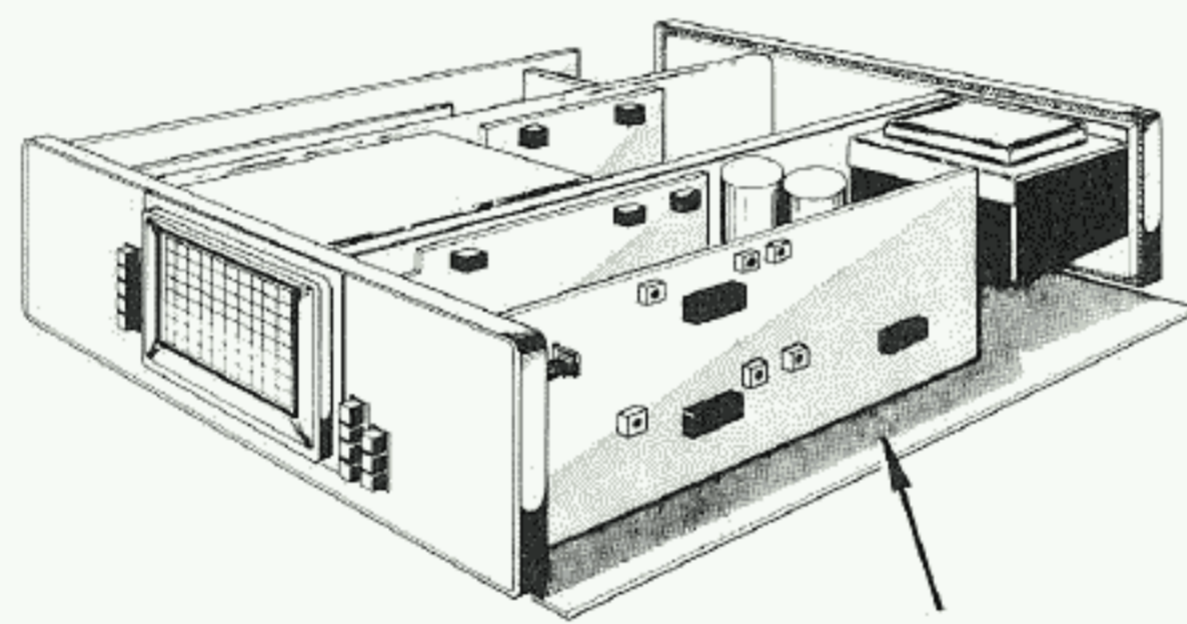

A9
INTERFACE
CIRCUIT BOARD



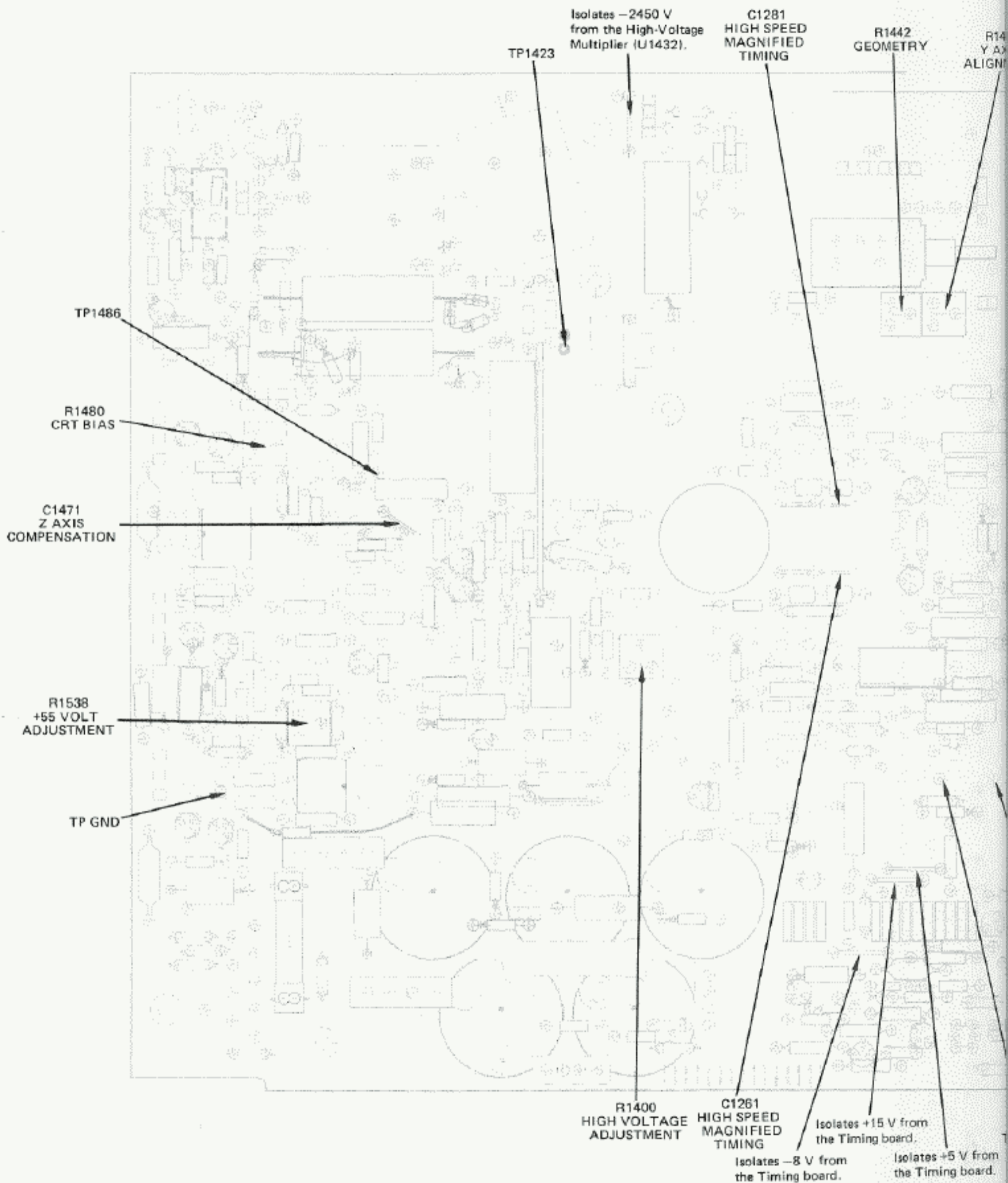
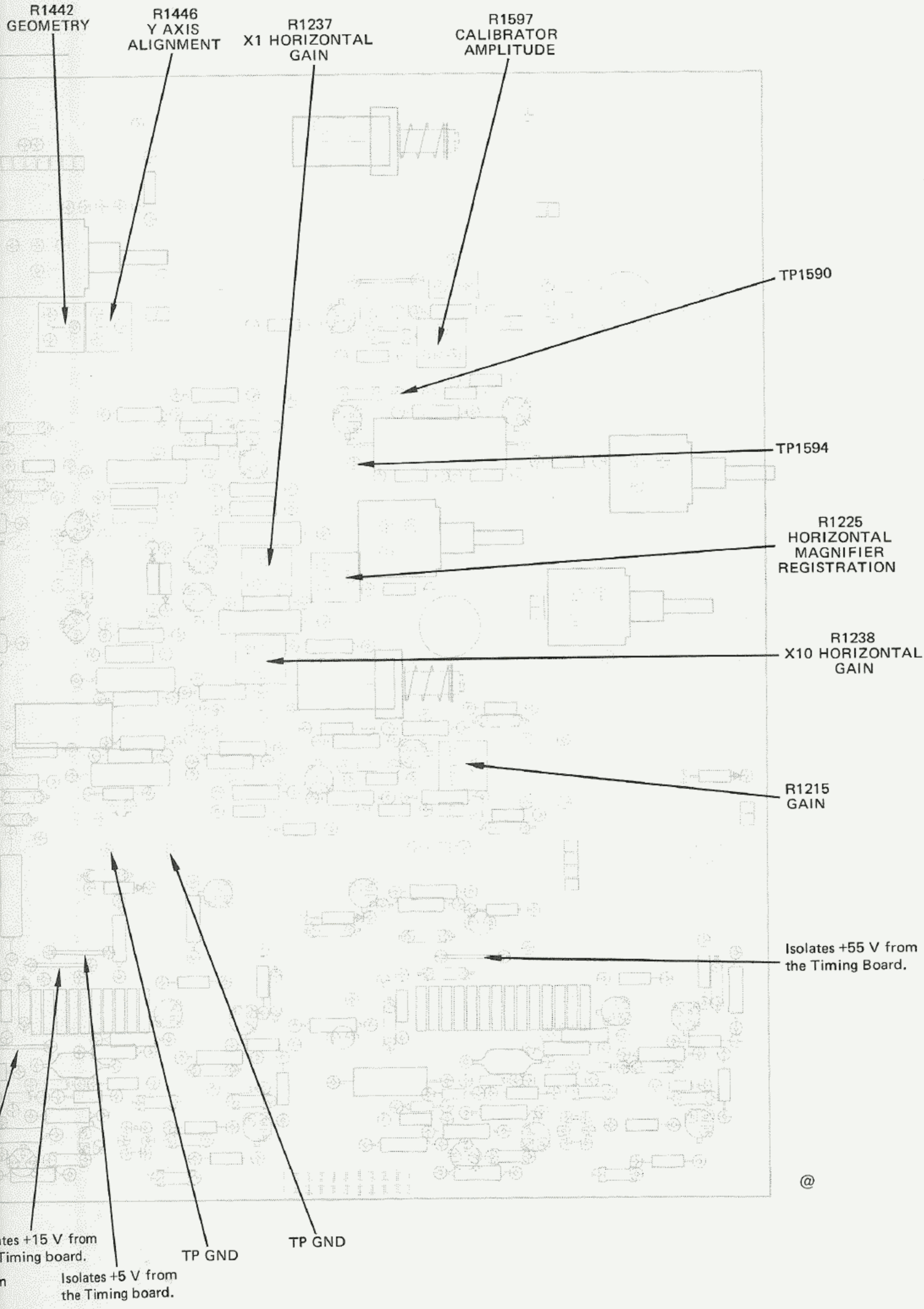

Fig. 8-19. Interface circuit board adjustment locations.



ates +15 V from
Timing board.

m
l.

it board adjustment locations.

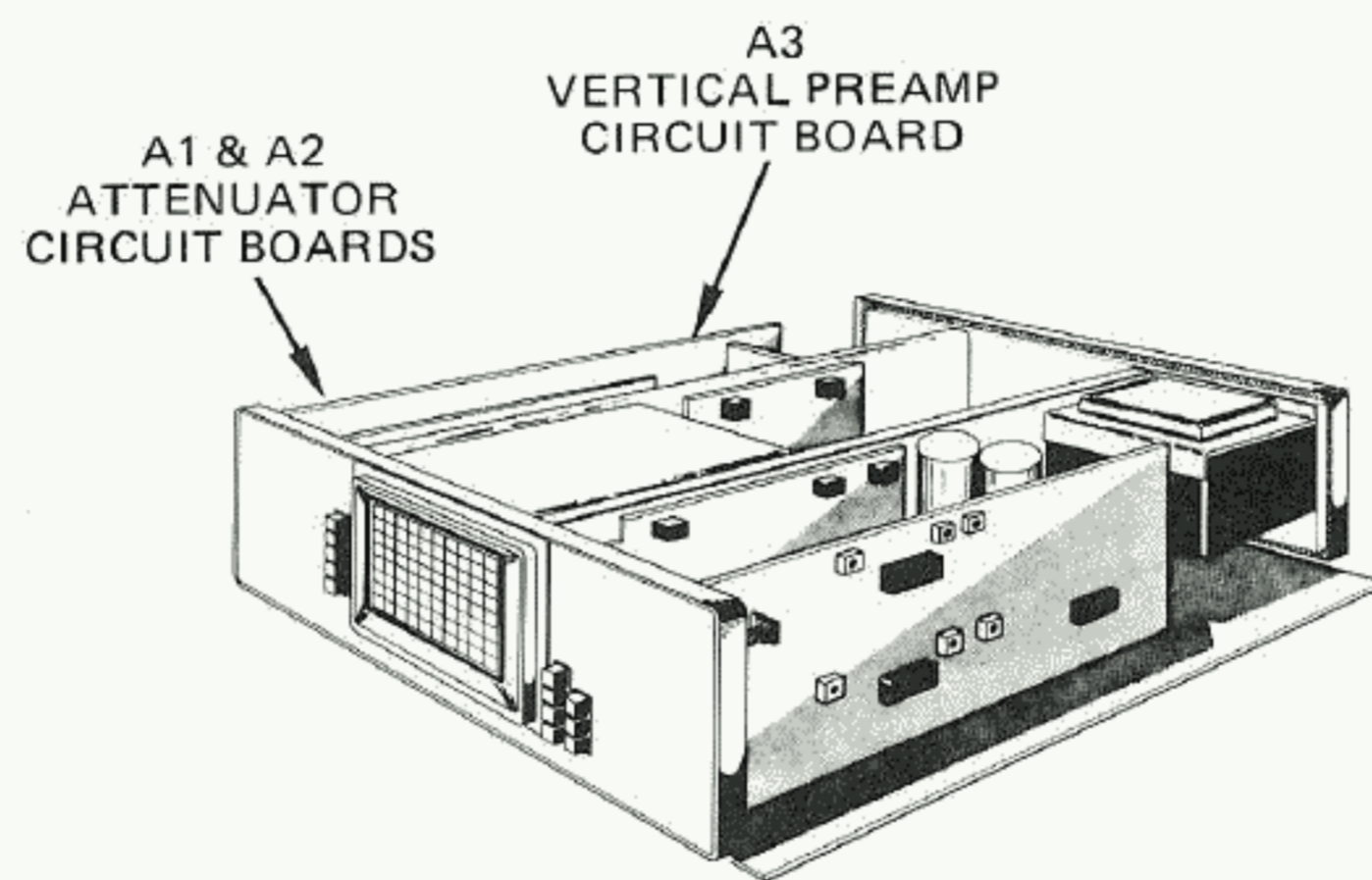

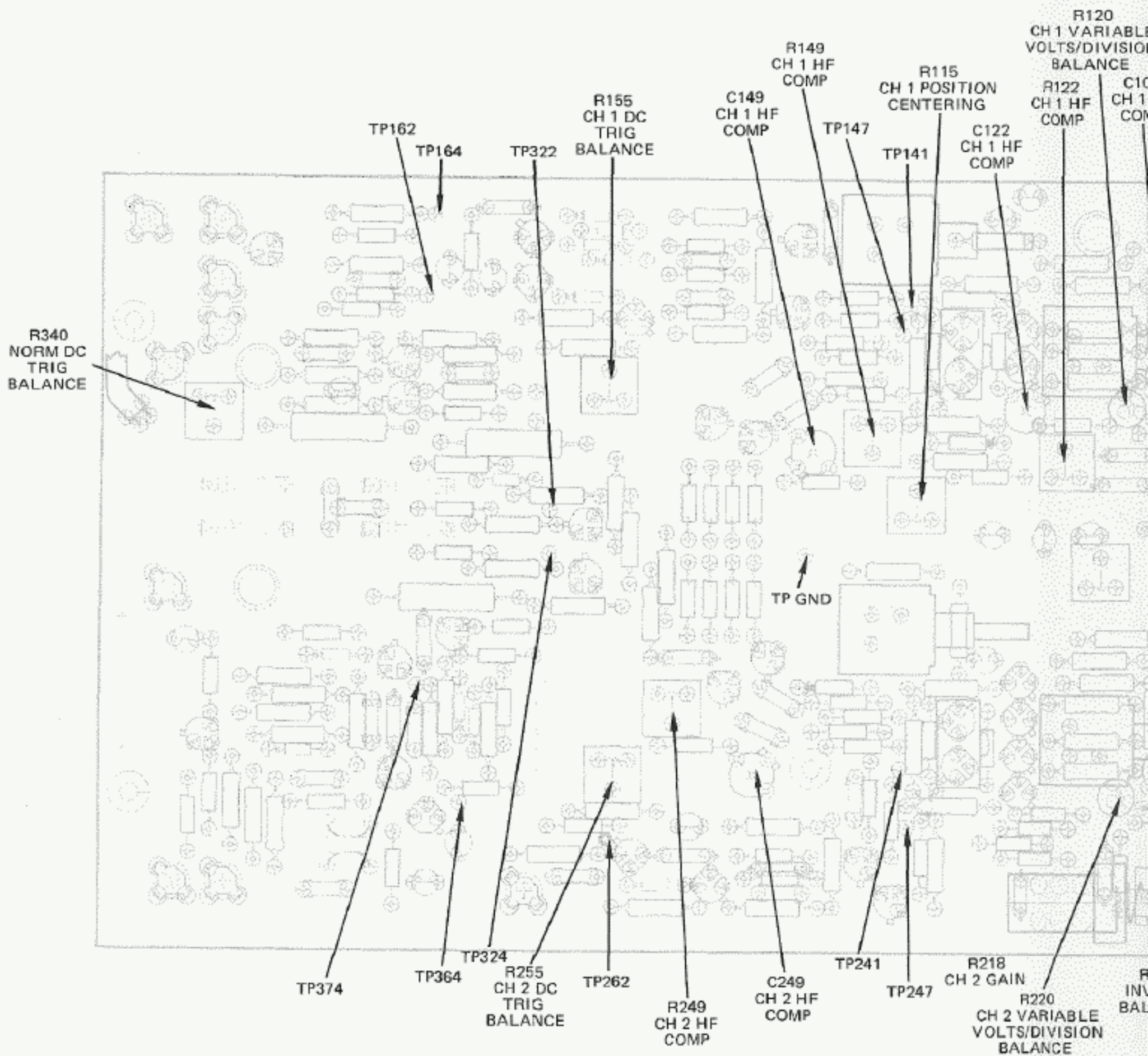
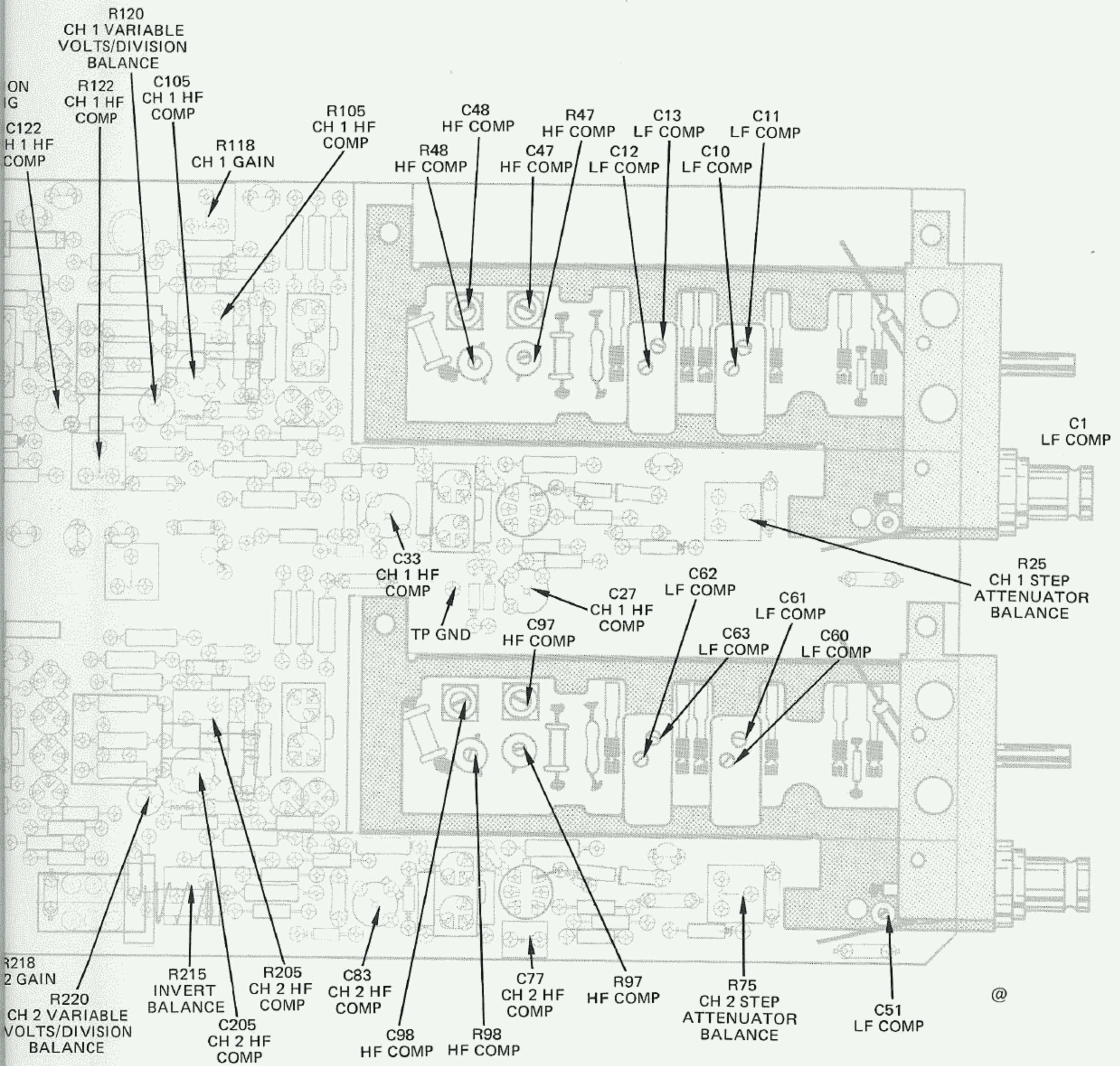
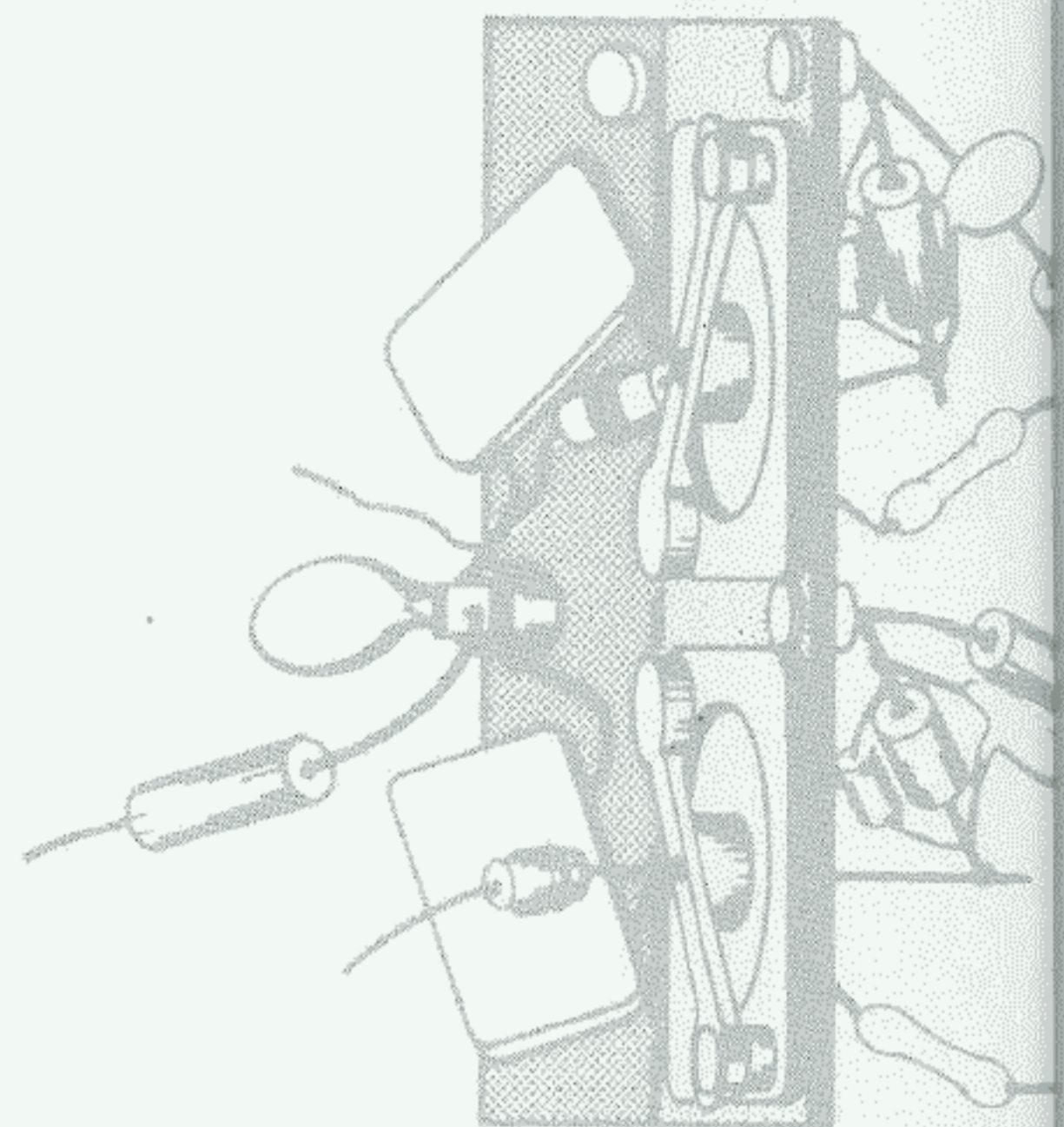
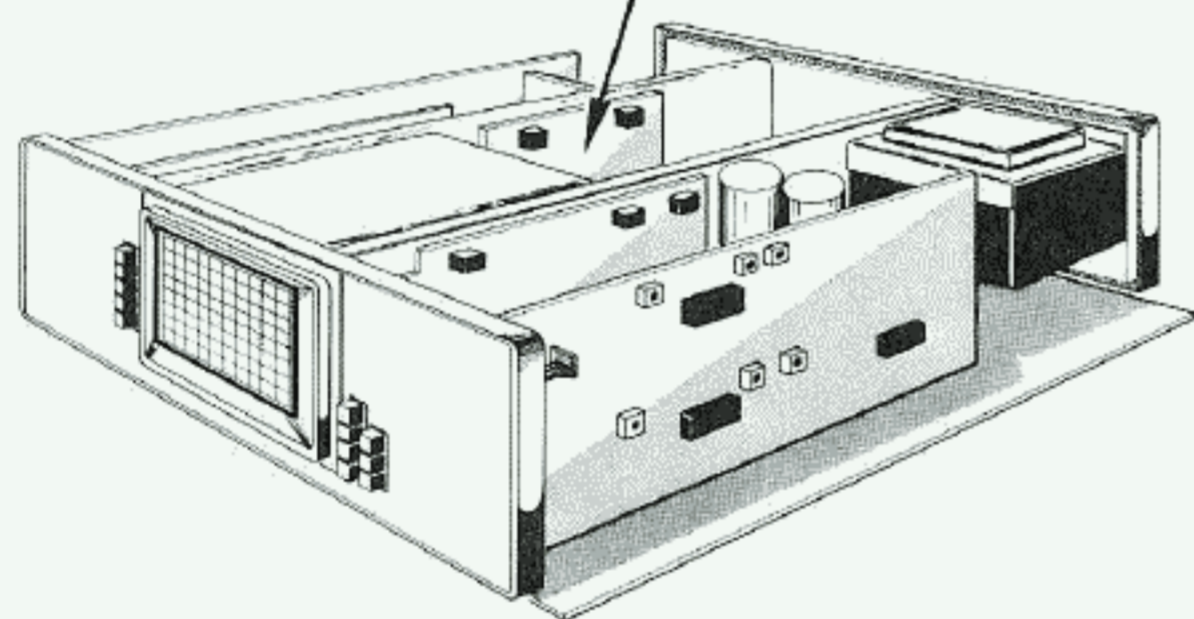

Fig. 8-20. Vertical Preamplifier and Attenuator circuit board



and Attenuator circuit board adjustment locations.

A5
VERTICAL OUTPUT
CIRCUIT BOARD



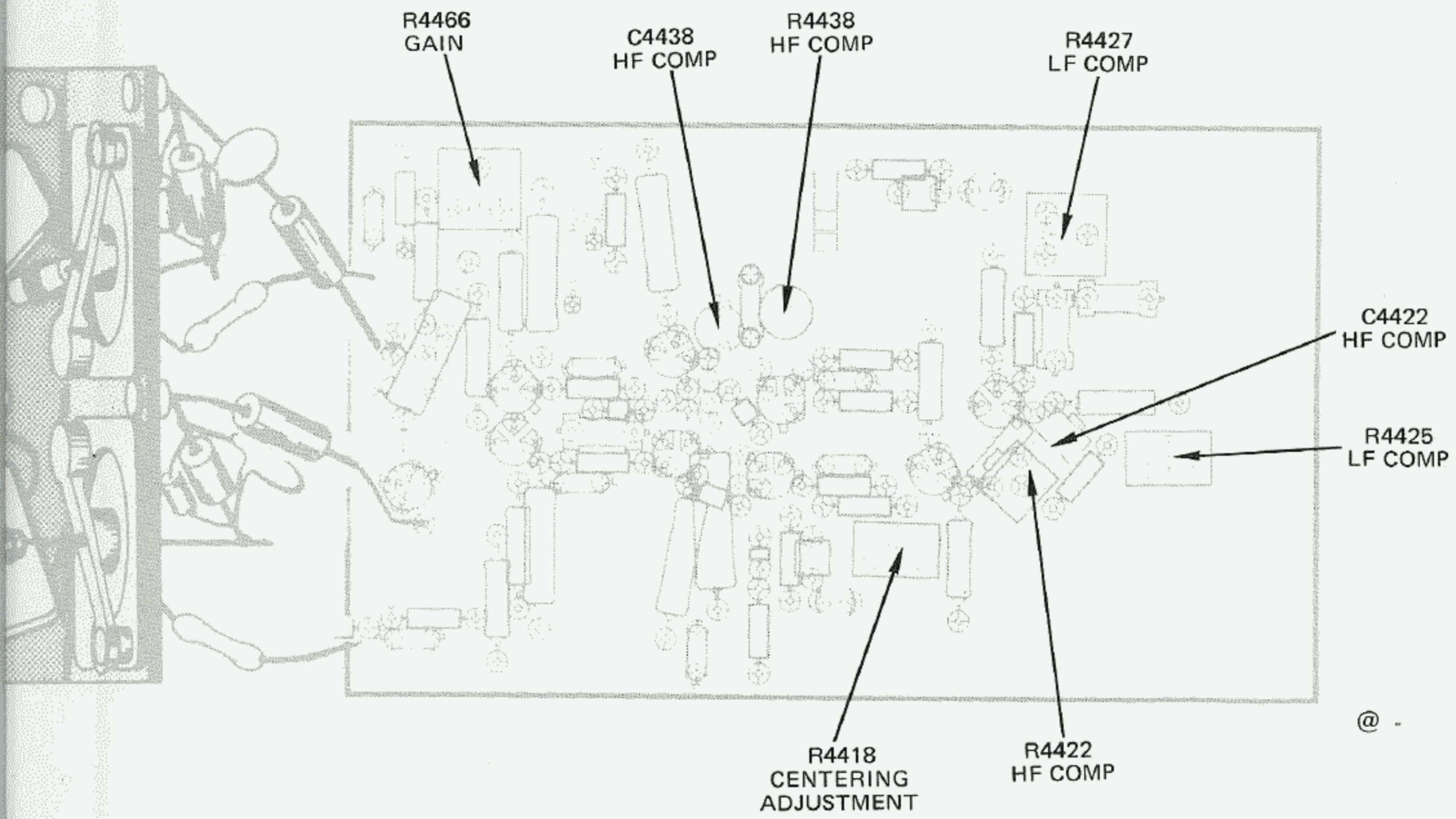
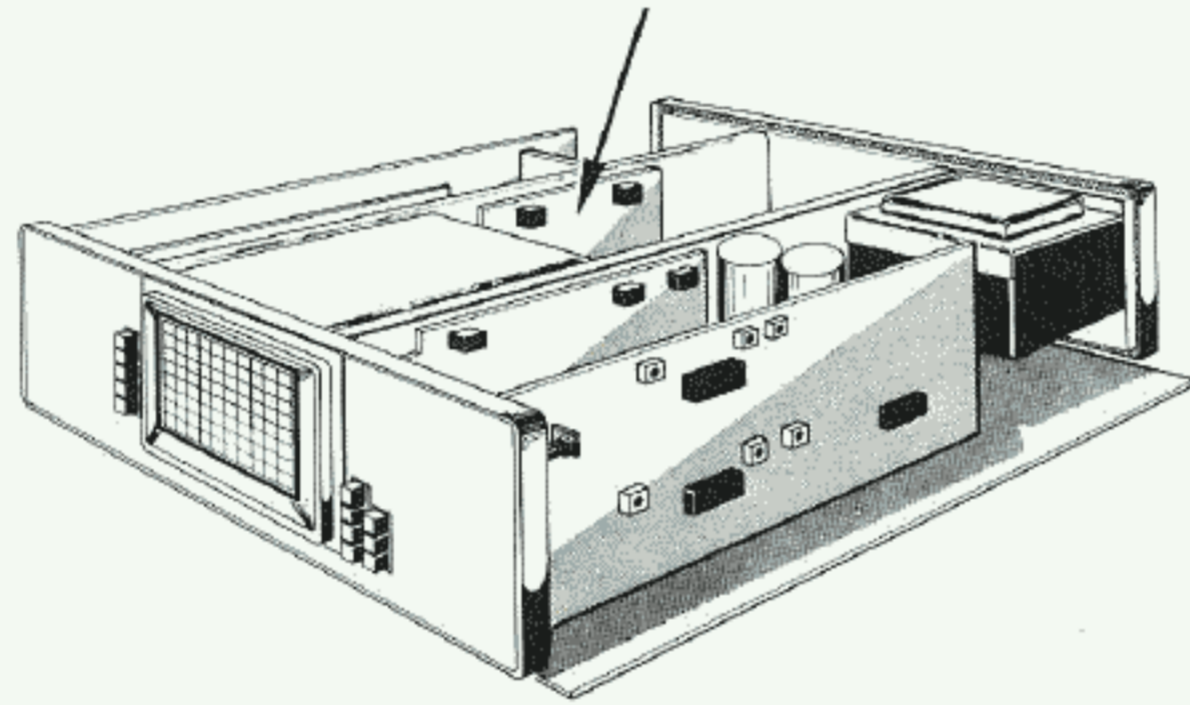

Fig. 8-21. Vertical Output Amplifier circuit board adjustment locations (discrete version).

A5
VERTICAL OUTPUT
CIRCUIT BOARD



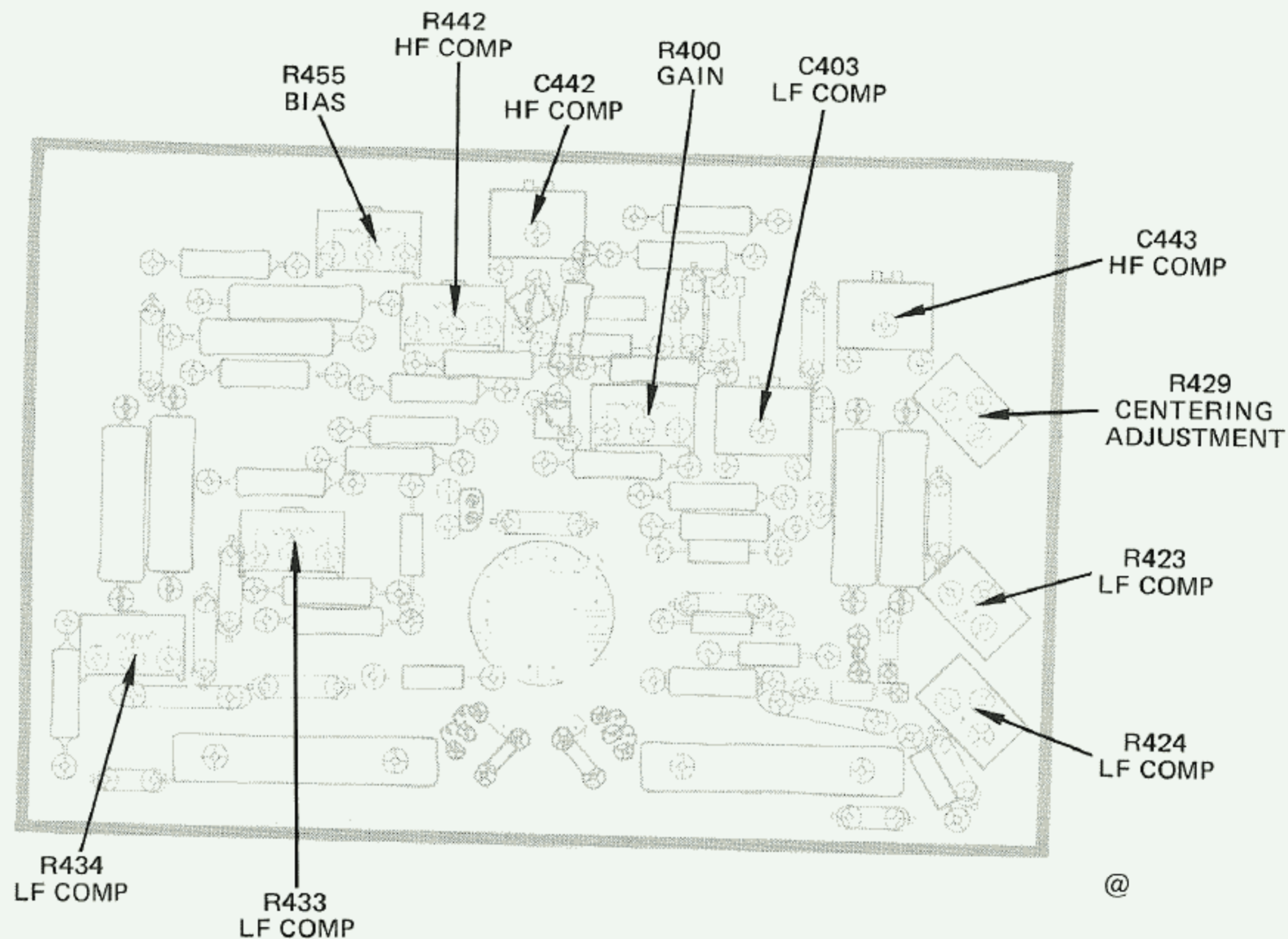
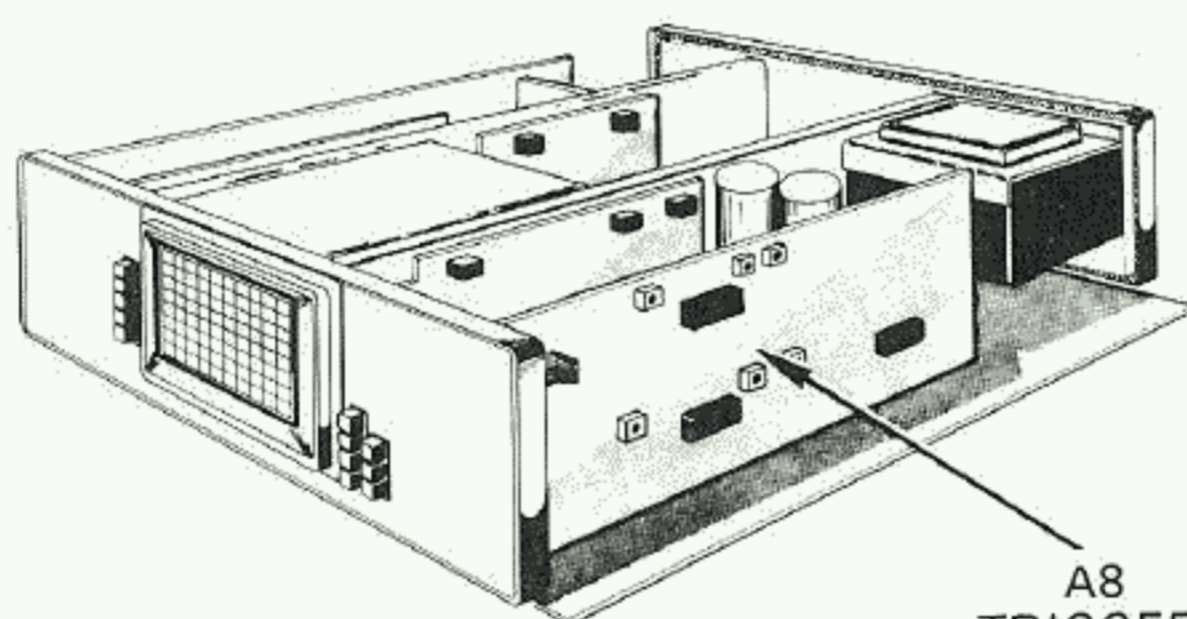

Fig. 8-22. Vertical Output Amplifier circuit board adjustment locations (IC version).



A8
TRIGGER
CIRCUIT BOARD



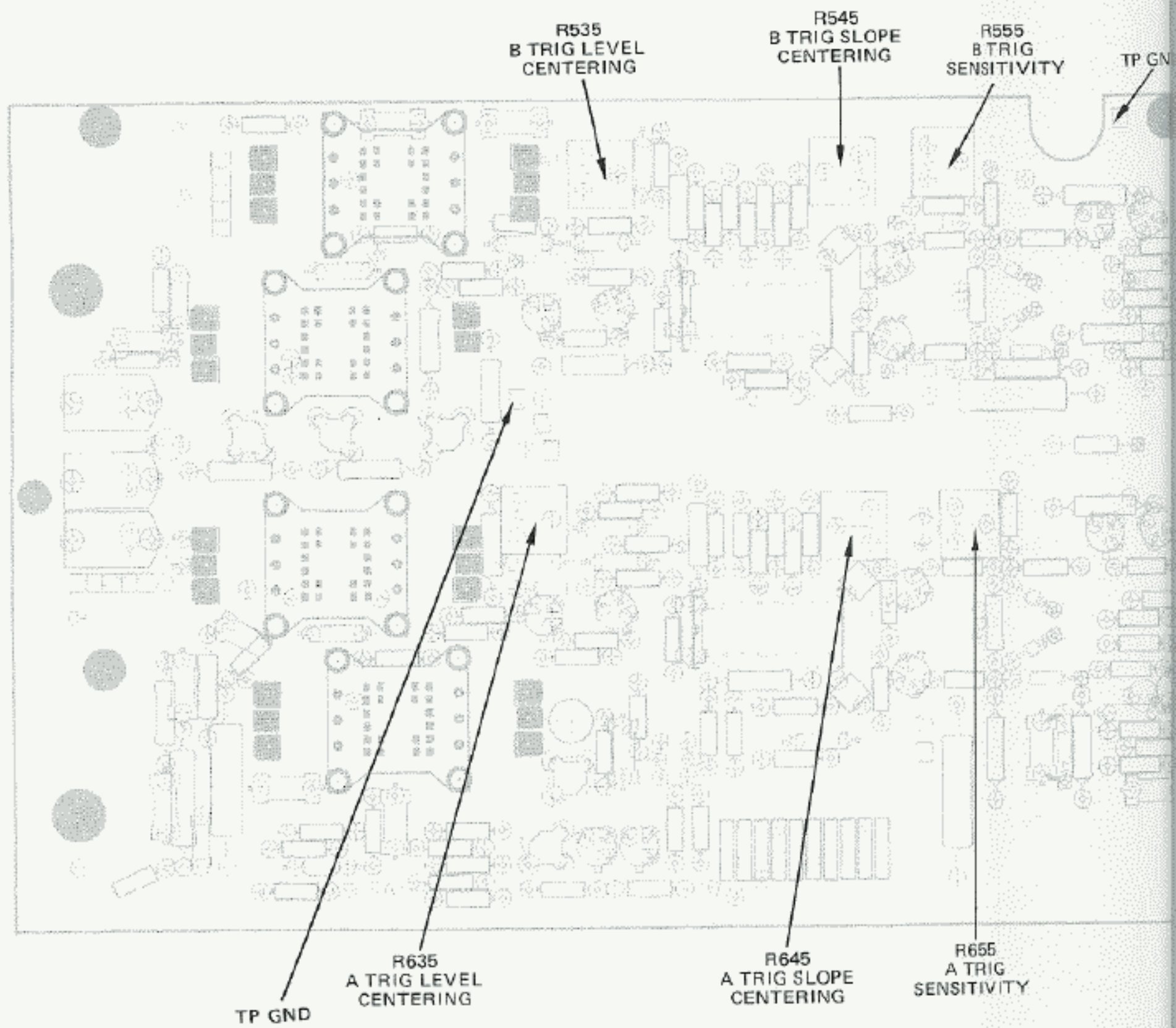
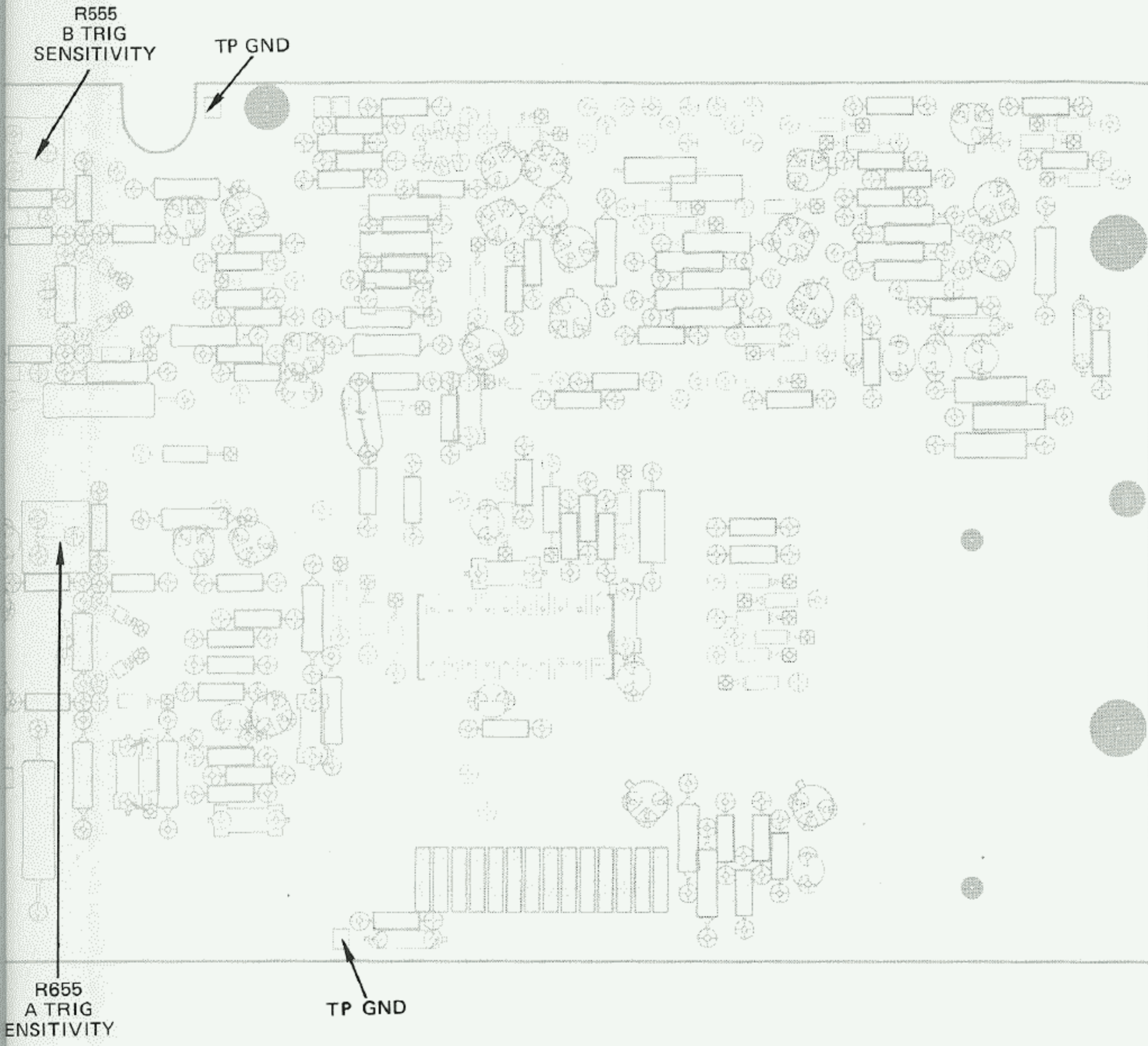
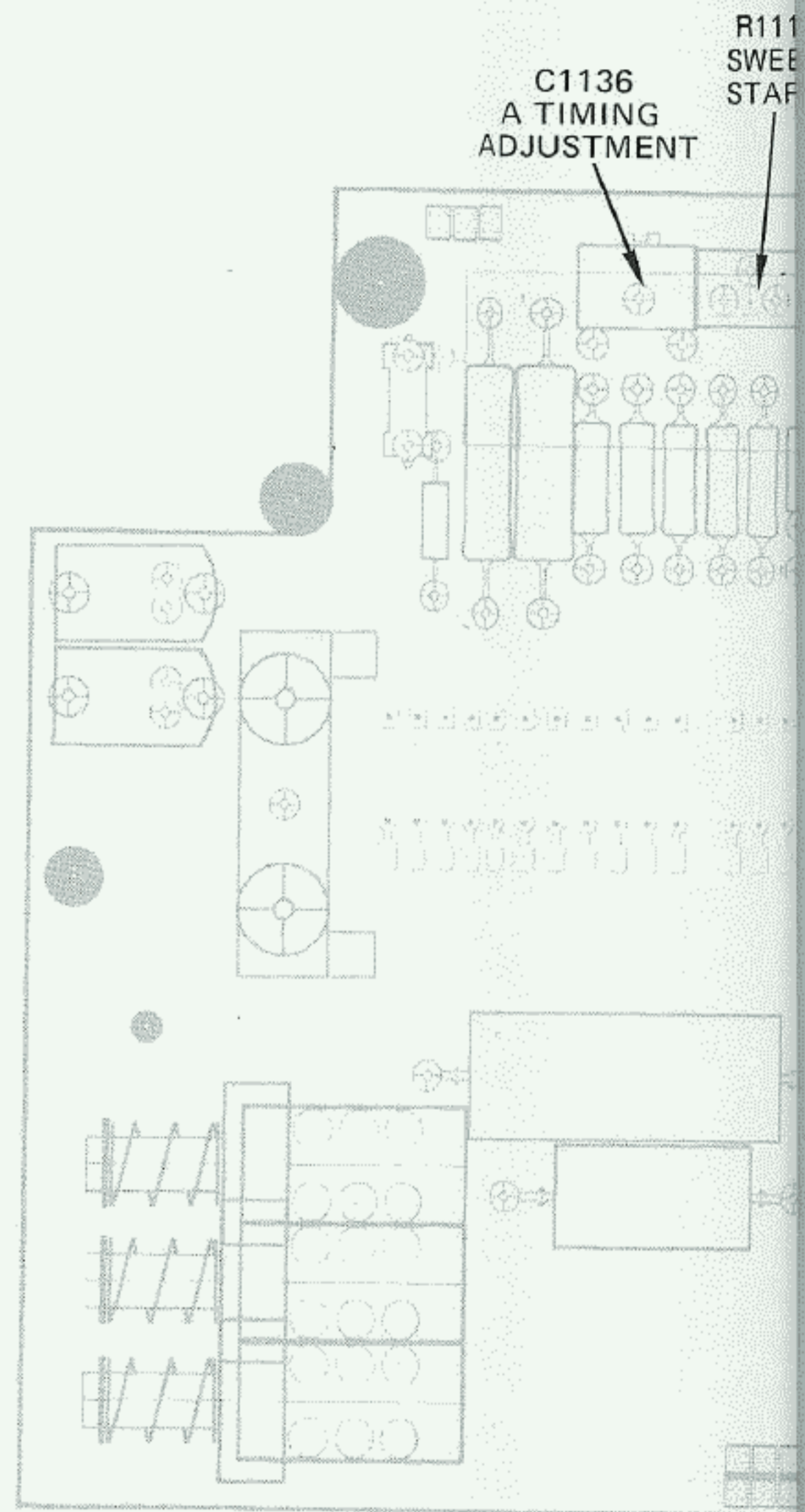
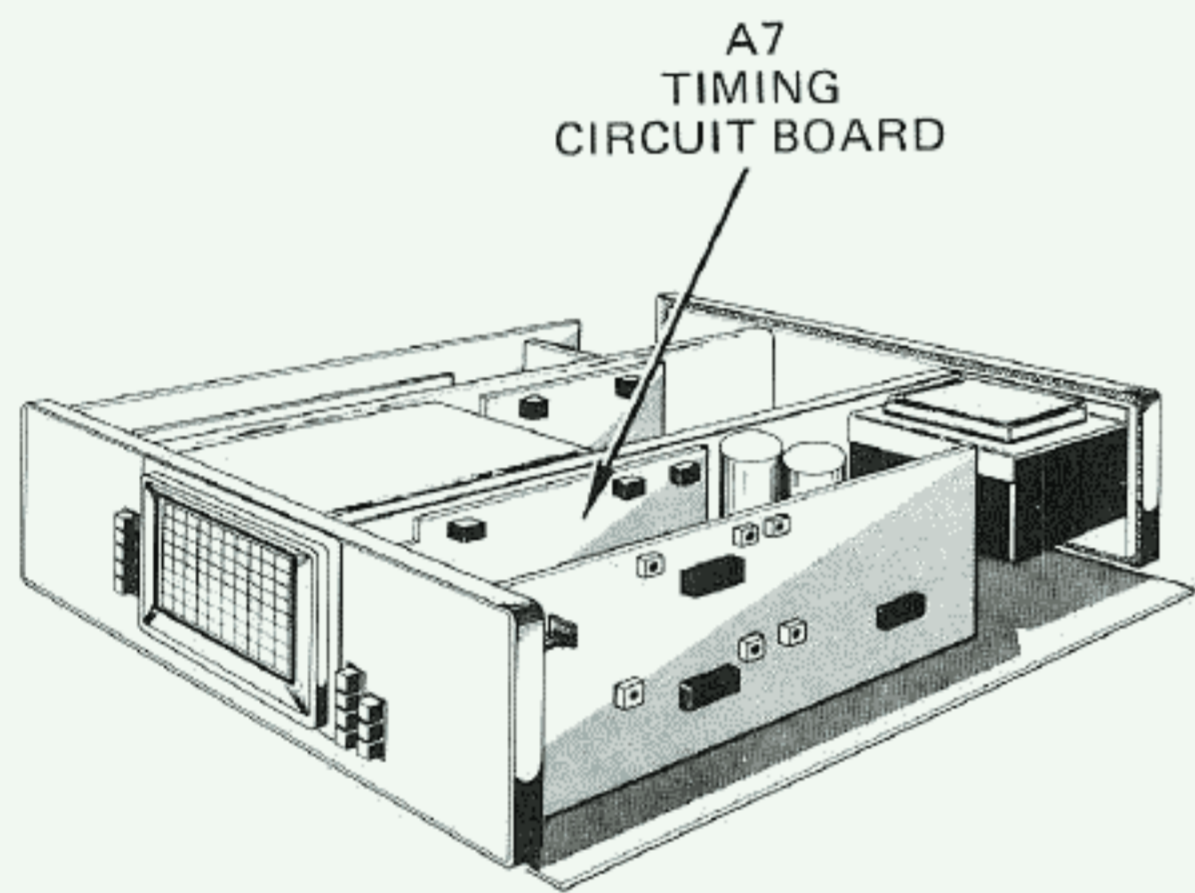

Fig. 8-23. Trigger Generator and Sweep Logic circuit



Generator and Sweep Logic circuit board adjustment locations.



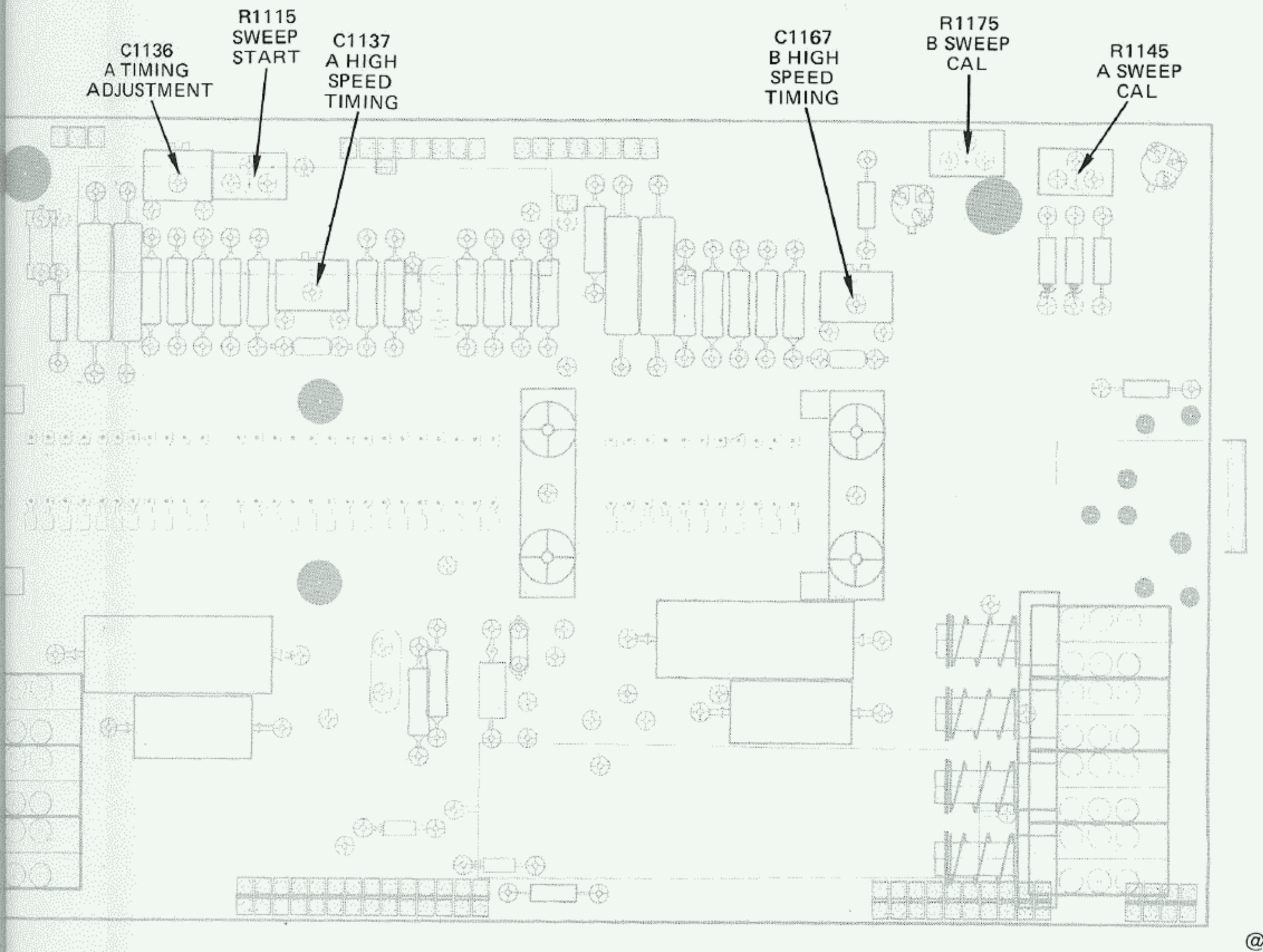

Fig. 8-24. Timing circuit board adjustment locations.

@

REPLACEABLE MECHANICAL PARTS

PARTS ORDERING INFORMATION

Replacement parts are available from or through your local Tektronix, Inc. Field Office or representative.

Changes to Tektronix instruments are sometimes made to accommodate improved components as they become available, and to give you the benefit of the latest circuit improvements developed in our engineering department. It is therefore important, when ordering parts, to include the following information in your order: Part number, instrument type or number, serial number, and modification number if applicable.

If a part you have ordered has been replaced with a new or improved part, your local Tektronix, Inc. Field Office or representative will contact you concerning any change in part number.

Change information, if any, is located at the rear of this manual.

SPECIAL NOTES AND SYMBOLS

X000 Part first added at this serial number
00X Part removed after this serial number

FIGURE AND INDEX NUMBERS

Items in this section are referenced by figure and index numbers to the illustrations.

INDENTATION SYSTEM

This mechanical parts list is indented to indicate item relationships. Following is an example of the indentation system used in the description column.

```

1 2 3 4 5           Name & Description
Assembly and/or Component
Attaching parts for Assembly and/or Component
    --- * ---
Detail Part of Assembly and/or Component
Attaching parts for Detail Part
    --- * ---
Parts of Detail Part
Attaching parts for Parts of Detail Part
    --- * ---

```

Attaching Parts always appear in the same indentation as the item it mounts, while the detail parts are indented to the right. Indented items are part of, and included with, the next higher indentation. The separation symbol --- * --- indicates the end of attaching parts.

Attaching parts must be purchased separately, unless otherwise specified.

ITEM NAME

In the Parts List, an Item Name is separated from the description by a colon (:). Because of space limitations, an Item Name may sometimes appear as incomplete. For further Item Name identification, the U.S. Federal Cataloging Handbook H6-1 can be utilized where possible.

ABBREVIATIONS

"	INCH	ELCTRN	ELECTRON	IN	INCH	SE	SINGLE END
#	NUMBER SIZE	ELEC	ELECTRICAL	INCAND	INCANDESCENT	SECT	SECTION
ACTR	ACTUATOR	ELCTLT	ELECTROLYTIC	INSUL	INSULATOR	SEMICOND	SEMICONDUCTOR
ADPTR	ADAPTER	ELEM	ELEMENT	INTL	INTERNAL	SHLD	SHIELD
ALIGN	ALIGNMENT	EPL	ELECTRICAL PARTS LIST	LPHLDR	LAMPHOLDER	SHLDR	SHOULDERED
AL	ALUMINUM	EQPT	EQUIPMENT	MACH	MACHINE	SKT	SOCKET
ASSEM	ASSEMBLED	EXT	EXTERNAL	MECH	MECHANICAL	SL	SLIDE
ASSY	ASSEMBLY	FIL	FILLISTER HEAD	MTG	MOUNTING	SLFLKG	SELF-LOCKING
ATTEN	ATTENUATOR	FLEX	FLEXIBLE	NIP	NIPPLE	SLVG	SLEEVING
AWG	AMERICAN WIRE GAGE	FLH	FLAT HEAD	NON WIRE	NOT WIRE WOUND	SPR	SPRING
BD	BOARD	FLTR	FILTER	OBD	ORDER BY DESCRIPTION	SQ	SQUARE
BRKT	BRACKET	FR	FRAME or FRONT	OD	OUTSIDE DIAMETER	SST	STAINLESS STEEL
BRS	BRASS	FSTNR	FASTENER	OVH	OVAL HEAD	STL	STEEL
BRZ	BRONZE	FT	FOOT	PH BRZ	PHOSPHOR BRONZE	SW	SWITCH
BSHG	BUSHING	FXD	FIXED	PL	PLAIN or PLATE	T	TUBE
CAB	CABINET	GSKT	GASKET	PLSTC	PLASTIC	TERM	TERMINAL
CAP	CAPACITOR	HDL	HANDLE	PN	PART NUMBER	THD	THREAD
CER	CERAMIC	HEX	HEXAGON	PNH	PAN HEAD	THK	THICK
CHAS	CHASSIS	HEX HD	HEXAGONAL HEAD	PWR	POWER	TNSN	TENSION
CKT	CIRCUIT	HEX SOC	HEXAGONAL SOCKET	RCPT	RECEPTACLE	TPG	TAPPING
COMP	COMPOSITION	HLCPS	HELICAL COMPRESSION	RES	RESISTOR	TRH	TRUSS HEAD
CONN	CONNECTOR	HLEXT	HELICAL EXTENSION	RGD	RIGID	V	VOLTAGE
COV	COVER	HV	HIGH VOLTAGE	RLF	RELIEF	VAR	VARIABLE
CPLG	COUPLING	IC	INTEGRATED CIRCUIT	RTNR	RETAINER	W/	WITH
CRT	CATHODE RAY TUBE	ID	INSIDE DIAMETER	SCH	SOCKET HEAD	WSHR	WASHER
DEG	DEGREE	IDENT	IDENTIFICATION	SCOPE	OSCILLOSCOPE	XFMR	TRANSFORMER
DWR	DRAWER	IMPLR	IMPELLER	SCR	SCREW	XSTR	TRANSISTOR

CROSS INDEX MFR. CODE NUMBER TO MANUFACTURER

MFR.CODE	MANUFACTURER	ADDRESS	CITY,STATE,ZIP
0000C	Gettig Engineering and Manufacturing Co.		Springmill, PA 16875
00779	AMP, Inc.	P. O. Box 3608	Harrisburg, PA 17105
01295	Texas Instruments, Inc., Components Group	P. O. Box 5012	Dallas, TX 75222
01963	Cherry Electrical Products Corp.	3600 Sunset Ave.	Waukegan, IL 60085
04941	Walsco Electronics Corp.	4 South Wyman	Rockford, IL 61101
05006	Twentieth Century Plastics Inc.	415 E. Washington Blvd.	Los Angeles, CA 90015
05129	Kilo Engineering Co.	2015 D	La Verne, CA 91750
05820	Wakefield Engineering, Inc.	Audubon Road	Wakefield, MA 01880
06982	Moore, Howard J., Co.	105 E. 16th St.	New York, NY 10003
08261	Spectra-Strip Corp.	7100 Lampson Ave.	Garden Grove, CA 92642
08530	Reliance Mica Corp.	342-39th St.	Brooklyn, NY 11232
09353	C and K Components, Inc.	103 Morse Street	Watertown, MA 02172
12327	Freeway Corp.	9301 Allen Dr.	Cleveland, OH 44125
12360	Albany Products Co., Div. of Pneumo Dynamics Corp.	351 Connecticut Ave.	South Norwalk, CT 06856
14438	USM Corp., Nylok Fastener Div.	3730 W. Morse	Lincolnwood, IL 60645
16428	Belden Corp.	P. O. Box 341	Richmond, IN 47374
22526	Berg Electronics, Inc.	Youk Expressway	New Cumberland, PA 17070
23050	Product Components Corp	30 Lorraine Ave.	Mt Vernon, NY 10553
23499	Gavitt Wire and Cable, Division of Amerace Corp.	455 N. Quince St.	Escondido, CA 92025
24931	Specialty Connector Co., Inc.	3560 Madison Ave.	Indianapolis, IN 46227
28817	Cal-Metex Corp., Subsidiary of Metex Corp.	509 Hindry Ave.	Inglewood, CA 90301
42838	National Rivet and Mfg. Co.	1-21 East Jefferson St.	Waupun, WI 53963
51316	Angelus Washer and Stamping Co.	1411 Esperanza St.	Los Angeles, CA 90023
70276	Allen Mfg. Co.	P. O. Drawer 570	Hartford, CT 06101
70278	Allied Steel and Conveyors, Div. of Sparton Corp.	17333 Healy	Detroit, MI 48212
70485	Atlantic India Rubber Works, Inc.	571 W. Polk St.	Chicago, IL 60607
71279	Cambridge Thermionic Corp.	445 Concord Ave.	Cambridge, MA 02138
71400	Bussman Mfg., Division of McGraw Edison Co.	2536 W. University St.	St. Louis, MO 63107
71590	Centralab Electronics, Div. of Globe-Union, Inc.	5757 N. Green Bay Ave.	Milwaukee, WI 53201
71785	TRW Electronic Components, Cinch Connector Operations	1501 Morse Ave.	Elk Grove Village, IL 60007
73743	Fischer Special Mfg. Co.	446 Morgan St.	Cincinnati, OH 45206
74445	Holo-Krome Co.	31 Brook St. West	Hartford, CT 06110
74921	Iten Fibre Co., The	4001 Benefit Ave.	Ashtabula, OH 44004
75497	Lamson and Sessions Co., The	5000 Tiedeman Road	Cleveland, OH 44144
75915	Littelfuse, Inc.	800 E. Northwest Hwy	Des Plaines, IL 60016
77250	Pheoll Manufacturing Co., Division of Allied Products Corp.	5700 W. Roosevelt Rd.	Chicago, IL 60650
78189	Illinois Tool Works, Inc. Shakeproof Division	St. Charles Road	Elgin, IL 60120
79136	Waldes, Kohinoor, Inc.	47-16 Austel Place	Long Island City, NY 11101
79807	Wrought Washer Mfg. Co.	2100 S. O Bay St.	Milwaukee, WI 53207
80009	Tektronix, Inc.	P. O. Box 500	Beaverton, OR 97077
80033	Prestole Everlock, Inc.	P. O. Box 278-1345 Miami St.	Toledo, OH 43605
82647	Texas Instruments, Inc., Control Products Div.	34 Forest St.	Attleboro, MA 02703
83385	Central Screw Co.	2530 Crescent Dr.	Broadview, IL 60153
88245	Litton Systems, Inc., USECO Div.	13536 Saticoy St.	Van Nuys, CA 91409
93410	Essex International, Inc., Controls Div. Mansfield Plant	P. O. Box 1007	Mansfield, OH 44903
97464	Industrial Retaining Ring Co.	57 Cordier St.	Irvington, NJ 07111
98278	Malco A Microdot Co., Inc., Connector and Cable Division	220 Pasadena Ave.	South Pasadena, CA 91030

Mechanical Parts List—465 Service (SN B250000-up)

FIGURE 1 FRONT AND REAR

Fig. & Index No.	Tektronix Part No.	Serial/Model No. Eff	No. Dscont	Qty	Name & Description					Mfr Code	Mfr Part Number
					1	2	3	4	5		
1-1	200-1411-00			1	BEZEL, CRT:					80009	200-1411-00
-2	213-0313-00			4	. THUMBSCREW:4-40 X 0.45 INCH,KNURLED					80009	213-0183-00
-3	337-1674-00			1	SHLD,ELCTR N TUB: CRT					80009	337-1674-00
-4	366-0494-00			2	KNOB:GRAY					80009	366-0494-00
	213-0153-00			1	. SETSCREW:5-40 X 0.125 INCH,HEX SOC STL					74445	OBD
-5	366-1031-02			2	KNOB:RED-VAR					80009	366-1031-02
	213-0153-00			1	. SETSCREW:5-40 X 0.125 INCH,HEX SOC STL					74445	OBD
-6	366-1426-00			2	KNOB:GRAY					80009	366-1426-00
	213-0153-00			1	. SETSCREW:5-40 X 0.125 INCH,HEX SOC STL					74445	OBD
-7	366-0215-02			2	KNOB:LEVER SWITCH					80009	366-0215-02
-8	366-1402-31			1	PUSH BUTTON:GRAY--INVERT					80009	366-1402-31
-9	366-1402-42			1	PUSH BUTTON:GRAY--BEAM FINDER					80009	366-1402-42
-10	366-1257-20			1	PUSH BUTTON:GRAY--CH2					80009	366-1257-20
-11	366-1402-37			1	PUSH BUTTON:GRAY--CHOP					80009	366-1402-37
-12	366-1257-16			1	PUSH BUTTON:GRAY--ADD					80009	366-1257-16
-13	366-1402-36			1	PUSH BUTTON:GRAY--ALT					80009	366-1402-36
-14	366-1257-19			1	PUSH BUTTON:GRAY--CH1					80009	366-1257-19
-15	366-1023-01			3	KNOB:GRAY					80009	366-1023-01
	213-0153-00			1	. SETSCREW:5-40 X 0.125 INCH,HEX SOC STL					74445	OBD
-16	366-1402-33			1	PUSH BUTTON:GRAY--X10					80009	366-1402-33
-17	366-1327-00			1	KNOB:GRAY					80009	366-1327-00
	213-0153-00			1	. SETSCREW:5-40 X 0.125 INCH,HEX SOC STL					74445	OBD
-18	366-1280-00			1	KNOB:GRAY					80009	366-1278-00
	213-0153-00			1	. SETSCREW:5-40 X 0.125 INCH,HEX SOC STL					74445	OBD
-19	366-1402-35			1	PUSH BUTTON:GRAY--B DLY'D					80009	366-1402-35
-20	366-1402-44			1	PUSH BUTTON:GRAY--A INTEN					80009	366-1402-44
-21	366-1402-29			1	PUSH BUTTON:GRAY--MIX					80009	366-1402-29
-22	366-1489-36			1	PUSH BUTTON:GRAY--A LOCK KNOBS					80009	366-1489-36
-23	366-1257-29			1	PUSH BUTTON:GRAY--SNGL SWP					80009	366-1257-29
-24	366-1402-39			1	PUSH BUTTON:GRAY--NORM					80009	366-1402-39
-25	366-1402-38			1	PUSH BUTTON:GRAY--AUTO					80009	366-1402-38
-26	331-0328-00			1	DIAL,CONTROL:10 TURN FOR 0.25 DIA SHAFT					05129	461-S-70
	213-0048-00			1	. SETSCREW:4-40 X 0.125 INCH,HEX SOC STL					74445	OBD
-27	366-1346-02			1	KNOB:RED					80009	366-1346-00
	213-0153-00			1	. SETSCREW:5-40 X 0.125 INCH,HEX SOC STL					74445	OBD
-28	366-1219-01			1	KNOB:GRAY--DLYD SWP					80009	366-1219-01
	213-0153-00			2	. SETSCREW:5-40 X 0.125 INCH,HEX SOC STL					74445	OBD
-29	354-0442-01			1	RING,KNOB SKIRT:PLASTIC,1.45 INCH DIA					80009	354-0442-01
	213-0005-00			1	. SETSCREW:8-32 X 1.25 INCH,HEX SOC STL					74445	OBD
-30	401-0080-00			1	BRG,KNOB SKIRT:0.789 ID X 0.866"OD PLASTIC					80009	401-0080-00
-31	366-0494-00			1	KNOB:GRAY					80009	366-0494-00
	213-0153-00			1	. SETSCREW:5-40 X 0.125 INCH,HEX SOC STL					74445	OBD
-32	366-1278-00			2	KNOB:GRAY					80009	366-1278-00
	213-0153-00			1	. SETSCREW:5-40 X 0.125 INCH,HEX SOC STL					74445	OBD
-33	366-1280-00			2	KNOB:GRAY					80009	366-1278-00
	213-0153-00			1	. SETSCREW:5-40 X 0.125 INCH,HEX SOC STL					74445	OBD
-34	358-0378-01	B250000	B252904	14	BUSHING,SLEEVE:0.25-32 X 0.535 INCH LONG					80009	358-0378-01
	358-0378-01	B252905		12	BUSHING,SLEEVE:0.25-32 X 0.535 INCH LONG					80009	358-0378-01
	358-0540-00	B252905		2	BSHG,MACH THD:0.25-32 X 0.128 ID X 0.25 LONG (ATTACHING PARTS FOR EACH)					80009	358-0540-00
	210-0583-00	B252905		1	NUT,PLAIN,HEX:0.25-32 X 0.312 INCH,BRS					73743	2X20319-402
	210-0940-00	B252905		1	WASHER,FLAT:0.25 ID X 0.375 INCH OD,STL - - - * - - -					79807	OBD
-35	358-0216-00			2	BUSHING,PLASTIC:0.257 ID X 0.412 INCH OD					80009	358-0216-00
-36	426-0681-00			16	FR,PUSH BUTTON:GRAY PLASTIC					80009	426-0681-00
-37	378-0803-01			2	LENS,LIGHT:CLEAR,ATTENUATOR					80009	378-0803-01
-38	378-0803-00			5	LENS,LIGHT:CLEAR					80009	378-0803-00
-39	358-0216-00			1	BUSHING,PLASTIC:0.257 ID X 0.412 INCH OD					80009	358-0216-00
-40	-----			4	RES.,VAR, NONWIR: (SEE R530,630,1155,1205 EPL) (ATTACHING PARTS FOR EACH)						
-41	210-0583-00			1	NUT,PLAIN,HEX.:0.25-32 X 0.312 INCH,BRS					73743	2X20319-402
-42	210-0940-00			1	WASHER,FLAT:0.25 ID X 0.375 INCH OD,STL - - - * - - -					79807	OBD
-43	-----			1	RES.,VAR,WV: (SEE R1110 EPL)						
-44	-----			2	CONN,RCPT,ELEC:W/HDWR (SEE J500,600 EPL)						
-45	119-0373-00			1	COIL,CALIBRATIO: (ATTACHING PARTS)					80009	119-0373-00
-46	210-0586-00			2	NUT,PLAIN,EXT W:4-40 X 0.25 INCH,STL					78189	OBD
-47	210-0851-00			2	WASHER,FLAT:0.119 ID X 0.375 INCH OD,STL					12327	OBD
-48	210-0811-00			2	WASH.,SHOULDERE:0.125 ID X 0.50 INCH OD					74921	6525

Mechanical Parts List—465 Service (SN B250000-up)

FIGURE 1 FRONT AND REAR (cont)

Fig. & Index No.	Tektronix Part No.	Serial/Model No. Eff	No. Dscont	Qty	1 2 3 4 5	Name & Description	Mfr Code	Mfr Part Number
1-49	361-0059-01			1		SPACER,CUR LOOP:1.094 X 0.344 X 0.125 INCH	80009	361-0059-01
-50	210-0593-00			2		NUT,FINISHING:0.25 HEX X 0.312" LONG,BRS - - - * - - -	80009	210-0593-00
-51	378-0635-00			4		LENS,LIGHT:WHITE	80009	378-0635-00
-52	333-1635-00			1		PANEL,FRONT:	80009	333-1635-00
-53	352-0340-00			2		LAMPHOLDER:SCALE FACTOR (ATTACHING PARTS)	80009	352-0340-00
-54	211-0001-00			1		SCREW,MACHINE:2-56 X 0.25 INCH,PNH STL - - - * - - -	83385	OBD
-55	-----			1		CKT BOARD ASSY:GRATICULE ILLUM(SEE A10 EPL)		
-56	378-0728-00			1		. REFLECTOR,LIGHT:SCALE ILLUMINATION	80009	378-0728-00
-57	352-0329-00			1		. LAMPHOLDER:SCALE ILLUMINATION	80009	352-0329-00
-58	175-0825-00			FT		. WIRE,ELECTRICAL:2 WIRE RIBBON	23499	TEK-175-0825-00
-59	131-0707-00			2		. CONTACT,ELEC:0.48"L,22-26 AWG WIRE	22526	47439
-60	352-0169-02			1		. CONN BODY,PL,BL:2 WIRE RED	80009	352-0169-00
-61	386-2340-00			4		SUPPORT,CRT:FRONT	80009	386-2340-00
-62	348-0276-00			FT		SHLD GSKT,ELEC:0.026 OD NPRNW/WIRE NET CO	28817	01-0404-3719
-63	426-1108-01			1		FRAME,CABINET:FRONT (ATTACHING PARTS)	80009	426-1108-01
-64	213-0183-00			4		SCR,TPG,THD FOR:6-32 X 0.25 INCH,PNH STL - - - * - - -	83385	OBD
-65	129-0388-00			2		POST,ELEC-MECH:1.673 INCH LONG	80009	129-0388-00
-66	348-0115-00			1		GROMMET,PLASTIC:U-SHP,0.548 X0.462 INCH	80009	348-0115-00
-67	337-1688-00			1		SHLD,ELECTRICAL:HIGH VOLTAGE (ATTACHING PARTS)	80009	337-1688-00
-68	211-0065-00			3		SCREW,MACHINE:4-40 X 0.188 INCH,PNH STL - - - * - - -	77250	OBD
-69	-----			1		CKT BOARD ASSY:FAN MOTOR(SEE A6 EPL) (ATTACHING PARTS)		
-70	213-0088-00			2		SCR,TPG,THD CTG:4-24 X 0.25 INCH,PNH STL - - - * - - -	83385	OBD
-71	136-0269-02			1		. SOCKET,PLUG-IN:14 CONTACT,LOW CLEARANCE	01295	C931402
-72	131-0608-00			2		. CONTACT,ELEC:0.365 INCH LONG	22526	47357
-73	136-0220-00			1		. SOCKET,PLUG-IN:3 PIN	71785	133-23-11-034
-74	-----			1		. MOTOR,DC:(SEE B1690 EPL)		
-75	426-0781-00			1		. MOUNT,MOTOR:	80009	426-0781-00
-76	337-1762-00			1		SHLD,ELECTRICAL:FAN MOTOR	80009	337-1762-00
-77	426-0781-00			1		MOUNT,MOTOR: (ATTACHING PARTS)	80009	426-0781-00
-78	213-0088-00			2		SCR,TPG,THD CTG:4-24 X 0.25 INCH,PNH STL - - - * - - -	83385	OBD
-79	-----			1		TRANSISTOR:CHAS MTG(SEE Q1418 EPL) (ATTACHING PARTS)		
-80	211-0012-00			2		SCREW,MACHINE:4-40 X 0.375 INCH,PNH STL	83385	OBD
-81	358-0214-00			2		INSULATOR,BSHG:0.25 DIA X 0.188 INCH L	80009	358-0214-00
-82	210-0205-00			1		TERMINAL,LUG:SE #8 - - - * - - -	78189	2104-08-00-2520N
-83	214-1610-00			1		HEAT SINK,ELEC:TRANSISTOR	80009	214-1610-00
-84	407-1153-00			1		BRKT,XSTR MTG: (ATTACHING PARTS)	80009	407-1153-00
-85	210-0586-00			2		NUT,PLAIN,EXT W:4-40 X 0.25 INCH,STL - - - * - - -	78189	OBD
-86	348-0253-00			1		GROMMET,PLASTIC:1.24 X 0.739 X 0.108" OA	80009	348-0253-00
-87	348-0064-00			2		GROMMET,PLASTIC:0.625 INCH DIA	80009	348-0064-00
	348-0063-00			1		GROMMET,PLASTIC:0.50 INCH DIA	80009	348-0063-00
-88	348-0056-00			4		GROMMET,PLASTIC:0.375 INCH DIA	80009	348-0056-00
-89	-----			1		DELAY LINE,ELEC:(SEE DL339 EPL) (ATTACHING PARTS)		
-90	407-1137-00			1		BRKT,DELAY LINE:	80009	407-1137-00
-91	210-0457-00			1		NUT,PLAIN,EXT W:6-32 X 0.312 INCH,STL - - - * - - -	83385	OBD
	-----			-		. DELAY LINE INCLUDES:		
	131-1002-02			1		. RETAINER,WIRE,E:	80009	131-1002-02
-92	348-0276-00			FT		SHLD GSKT,ELEC:0.026 OD NPRNW/WIRE NET CO	28817	01-0404-3719

Mechanical Parts List—465 Service (SN B250000-up)

FIGURE 1 FRONT & REAR (CONT)

Fig. & Index No.	Tektronix Part No.	Serial/Model No. Eff	No. Dscont	Qty	1 2 3 4 5					Name & Description	Mfr Code	Mfr Part Number
1-93	348-0339-00			4						FOOT,CABINET:W/CORD WRAP (ATTACHING PARTS FOR EACH)	80009	348-0339-00
-94	212-0020-00			1						SCREW,MACHINE:8-32 X 1.0 INCH,PNH STL - - - * - - -	83385	OBD
-95	426-0970-00			1						FRAME SECT,CAB:REAR (ATTACHING PARTS)	80009	426-0970-00
-96	211-0516-00			2						SCREW,MACHINE:6-32 X 0.875 INCH,PNH STL - - - * - - -	83385	OBD
-97	378-0044-01			1						FIL ELEM,AIR CO:2.5 SQ X 0.25 INCH THK	80009	378-0044-01
-98	-----			4						CONN,RCPT,ELEC:(SEE J165,1318,1338,1450 EPL) (ATTACHING PARTS FOR EACH)		
-99	210-0255-00			1						TERMINAL,LUG:0.391" ID INT TOOTH - - - * - - -	80009	210-0255-00
-100	386-2408-00 200-1414-01			1 1						PLATE,CONN MTG:BNC CONNECTORS COVER,OSCP,REAR:ASSEMBLY (ATTACHING PARTS)	80009	386-2408-00
-101	211-0101-00			2						SCREW,MACHINE:4-40 X 0.25" 100 DEG,FLH STL - - - * - - -	83385	OBD
-102	200-1414-00			1						. COVER INCLUDES: . COVER,SCOPE:REAR	80009	200-1414-01
-103	378-0807-01			1						. SCREEN,FAN:	80009	378-0807-01
-104	200-1399-01			1						. COVER,FAN IMPLR:	80009	200-1399-01
-105	369-0031-01			1						IMPLR,FAN,AXIAL:	80009	369-0031-01
-106	105-0507-00			1						. STOP,SFT,END PL:	80009	105-0507-00
	213-0022-00			1						. SETSCREW:4-40 X 0.188 INCH,HEX SOC STL	74445	OBD
-107	200-1445-01			1						COV ASSY,LINE V:	80009	200-1445-01
-108	352-0102-00			1						. FUSEHOLDER:0.262"ID TUBE FOR CRTG FUSE (ATTACHING PARTS)	80009	352-0102-00
-109	213-0034-00			2						. SCR,TPG,THD CTG:4-40 X 0.188 INCH,PNH STL - - - * - - -	83385	OBD
-110	204-0549-01			1						BODY ASSY,LINE: (ATTACHING PARTS)	80009	204-0549-01
-111	210-0407-00			2						NUT,PLAIN,HEX.:6-32 X 0.25 INCH,BRS	73743	3038-0228-402
-112	210-0006-00			2						WASHER,LOCK:INTL,0.146 ID X 0.283"OD,STL - - - * - - -	78189	1206-00-00-0541C
	214-0778-00			1						. BODY ASSY INCLUDES: . CONTACT ASSY:SELECTOR BLOCK	80009	214-0778-00
	131-1318-01			1						. CONTACT,ELEC:SHORTING BAR	80009	131-1318-01
-113	161-0033-07			1						CABLE ASSY,PWR,:3 WIRE,92 INCH LONG (ATTACHING PARTS)	16428	KH8002
-114	358-0371-00			1						BSHG,STRAIN RLF:90 DEG,0.25" DIA HOLD	80009	358-0371-00
-115	200-1004-00			1						CABLE,NIP.,ELEC:0.265 ID X 0.38"OD W/FLG	80009	200-1004-00
-116	358-0372-00			1						BSHG,STRAIN RLF:180 DEG,0.156 INCH DIA HOLE - - - * - - -	80009	358-0372-00
-117	386-2332-00			1						PANEL,REAR: (ATTACHING PARTS)	80009	386-2332-00
-118	211-0105-00			1						SCREW,MACHINE:4-40 X 0.188"100 DEG,FLH STL	83385	OBD
-119	211-0138-00			1						SCREW,MACHINE:5-40 X 2.562 INCH,PNH STL	83385	OBD
-120	210-0201-00			1						TERMINAL,LUG:SE #4	78189	2104-04-00-2520N
-121	210-0586-00			1						NUT,PLAIN,EXT W:4-40 X 0.25 INCH,STL - - - * - - -	78189	OBD
-122	260-0638-00			1						SW,THERMOSTATIC:10A,240V,OPEN 75 DEG C (ATTACHING PARTS)	93410	S3530
-123	213-0044-00			2						SCR,TPG,THD FOR:5-32 X 0.188 INCH,PNH STL - - - * - - -	83385	OBD
-124	-----			1						XFMR,PWR,STPDN:(SEE T1501 EPL) (ATTACHING PARTS)		
-125	211-0538-00			2						SCREW,MACHINE:6-32 X 0.312"100 DEG,FLH STL	83385	OBD
-126	210-0457-00			4						NUT,PLAIN,EXT W:6-32 X 0.312 INCH,STL - - - * - - -	83385	OBD

Mechanical Parts List—465 Service (SN B250000-up)

FIGURE 1 FRONT & REAR (CONT)

Fig. & Index No.	Tektronix Part No.	Serial/Model No. Eff	No. Dscont	Qty	1	2	3	4	5	Name & Description	Mfr Code	Mfr Part Number
1	-----	-----		-						. TRANSFORMER INCLUDES:		
-127	407-1066-00			1						. BRKT, XFMR MTG:	80009	407-1066-00
-128	212-0522-00			4						. SCREW, MACHINE: 10-32 X 2.50", HEX HD STL	83385	OBD
-129	210-0812-00			4						. WASHER, NONMETAL: #10, FIBER	06982	OBD
-130	166-0457-00			4						. INSUL SLVG, ELEC: 0.19 ID X 1.875" LONG MYLAR	80009	166-0457-00
-131	200-1544-01			1						. COVER, XFMR: 3 L X 2.5 W X 0.65 INCH H	80009	200-1544-01
-132	210-0056-00			4						. WASHER, LOCK: SPLIT, 0.047 ID X 0.32" OD, P BRZ	83385	OBD
-133	220-0561-00			4						. NUT, PLAIN, HEX.: 10-32 X 0.25 INCH, BRS	80009	220-0561-00
-134	337-1763-01			1						SHIELD, ELEC: TRANSFORMER	80009	337-1763-01
-135	210-0201-00			1						TERMINAL, LUG: SE #4	78189	2104-04-00-2520N
										(ATTACHING PARTS)		
-136	210-0586-00			1						NUT, PLAIN, EXT W: 4-40 X 0.25 INCH, STL	78189	OBD
										- - - * - - -		
-137	-----	-----		3						TRANSISTOR: (SEE Q1566, Q1534, Q1546 EPL)		
										(ATTACHING PARTS FOR EACH)		
-138	211-0012-00			1						SCREW, MACHINE: 4-40 X 0.375 INCH, PNH STL	83385	OBD
-139	210-0071-00			1						WASHER, SPR TNSN: 0.146 ID X 0.323 INCH OD, STL	78189	4706-05-01-0531
										- - - * - - -		
-140	342-0163-00			3						INSULATOR, PLATE: XSTR, 0.675 X 0.625 X 0.001"	80009	342-0163-00
-141	348-0064-00			2						GROMMET, PLASTIC: 0.625 INCH DIA	80009	348-0064-00
-142	344-0250-00			1						CLIP, ELECTRICAL: COMPONENT MOUNTING	80033	E5001-041
										(ATTACHING PARTS)		
-143	211-0008-00			1						SCREW, MACHINE: 4-40 X 0.25 INCH, PNH STL	83385	OBD
-144	210-0586-00			1						NUT, PLAIN, EXT W: 4-40 X 0.25 INCH, STL	78189	OBD
										- - - * - - -		
-145	-----	-----		1						COIL, TUBE DEFLE: (SEE L1440 EPL)		
-146	441-1084-03			1						CHAS, ELEC EQPT: MAIN	80009	441-1084-03
	214-0291-00			1						. CONTACT, SPRING: 1.188 X 0.375 X 0.25 INCH	80009	214-0291-00
										(ATTACHING PARTS)		
	210-0633-01			1						. EYELET, METALLIC:	80009	210-0633-01
										- - - * - - -		
	136-0515-01			1						SKT, ELCTRN TUBE: CRT	80009	136-0515-01
-147	136-0202-01			1						. SOCKET, PLUG-IN: 14 PIN	80009	136-0202-01
-148	131-0707-00			4						. CONTACT, ELEC: 0.48"L, 22-26 AWG WIRE	22526	47439
-149	352-0162-00			1						. HOLDER, TERM.CON: 4 WIRE BLACK	80009	352-0162-00
-150	179-1873-00			1						WIRING HARNESS: TRIGGER	80009	179-1873-00
-151	210-0774-00			8						. EYELET, METALLIC: 0.152 OD X 0.245 INCH L, BRS	80009	210-0774-00
-152	210-0775-00			8						. EYELET, METALLIC: 0.126 OD X 0.23 INCH L, BRS	80009	210-0775-00
-153	352-0169-00			2						. HOLDER, TERM.CON: 2 WIRE BLACK	80009	352-0169-00
	131-0707-00			4						. CONTACT, ELEC: 0.48"L, 22-26 AWG WIRE	22526	47439

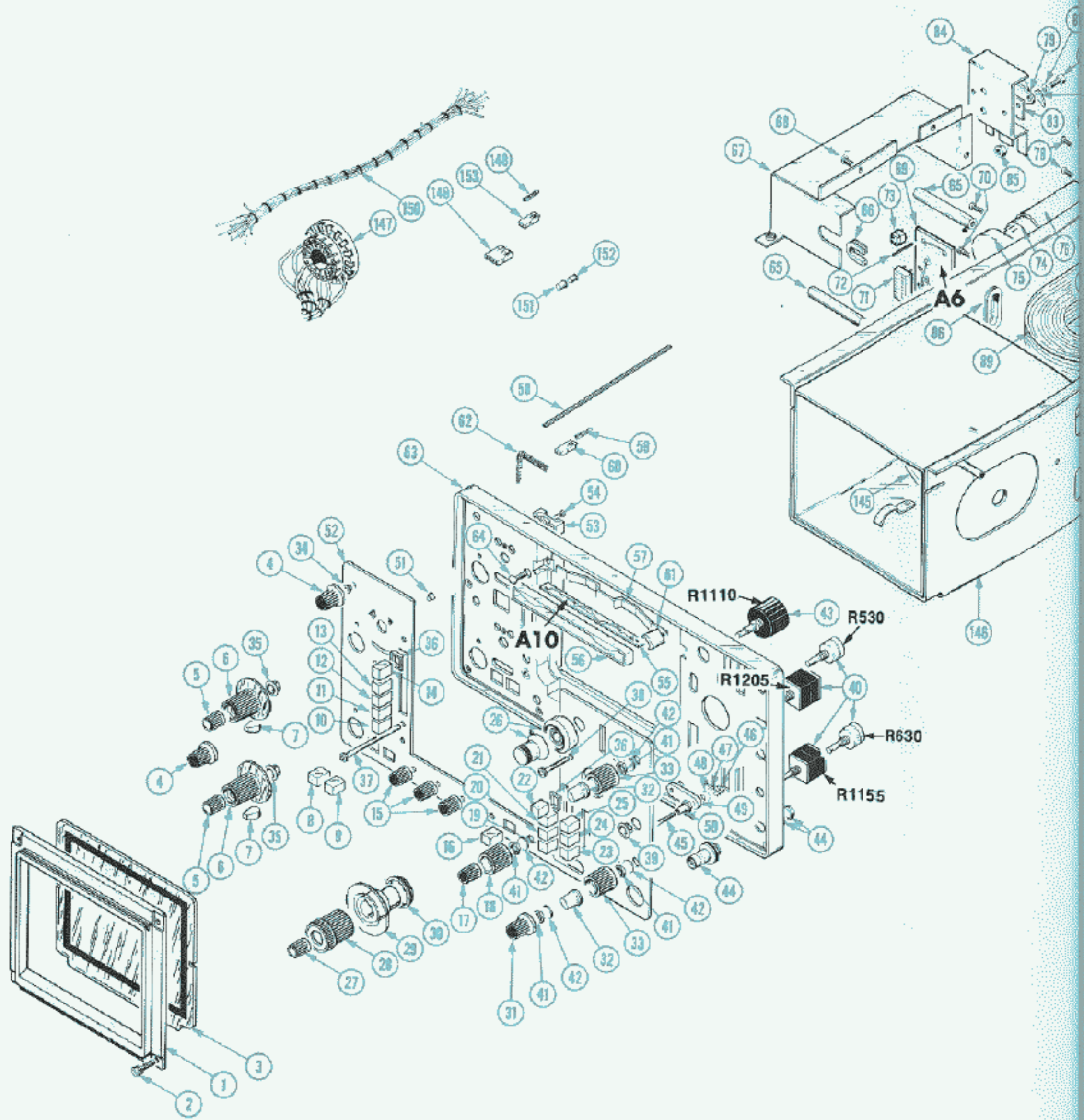

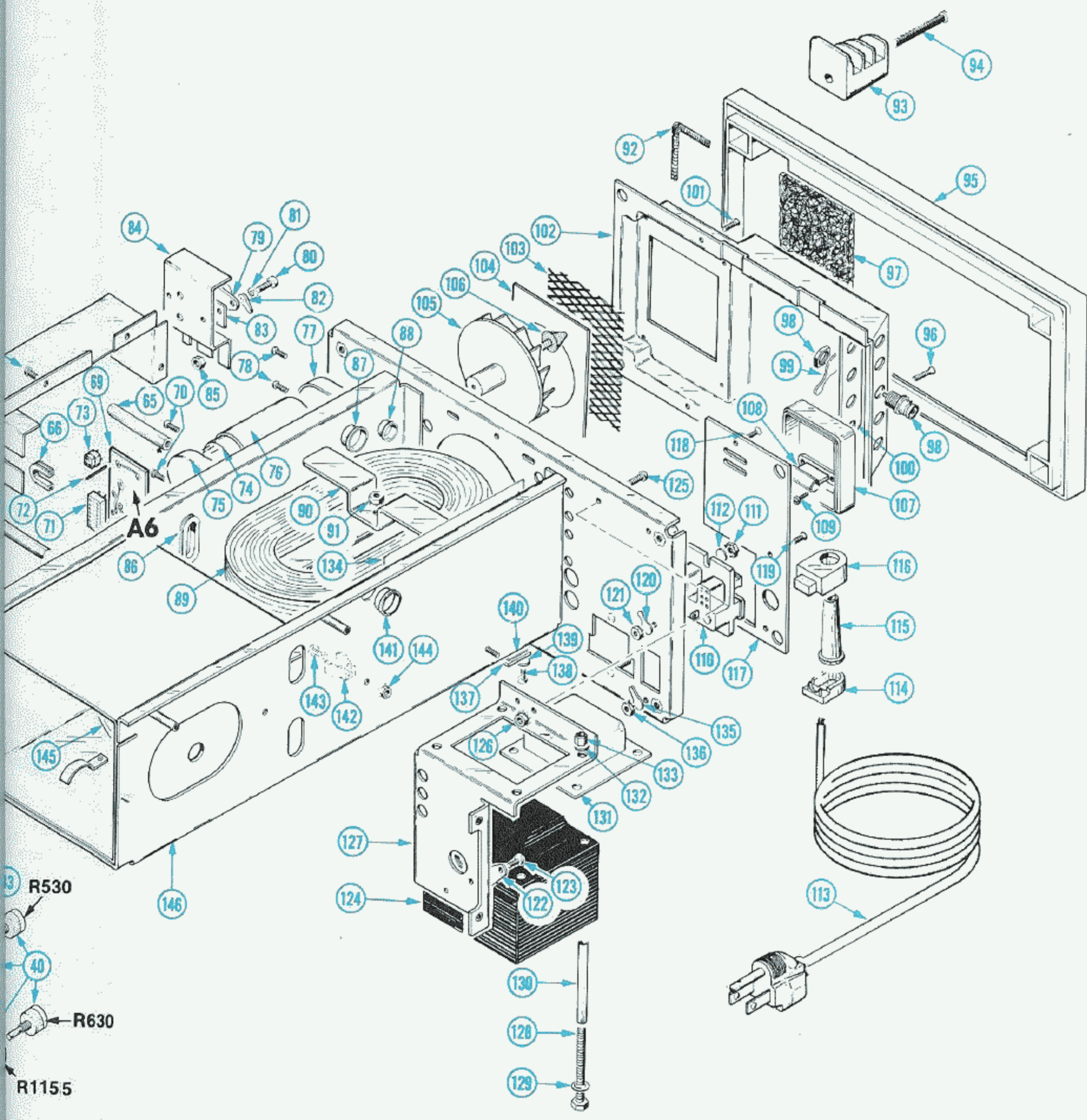

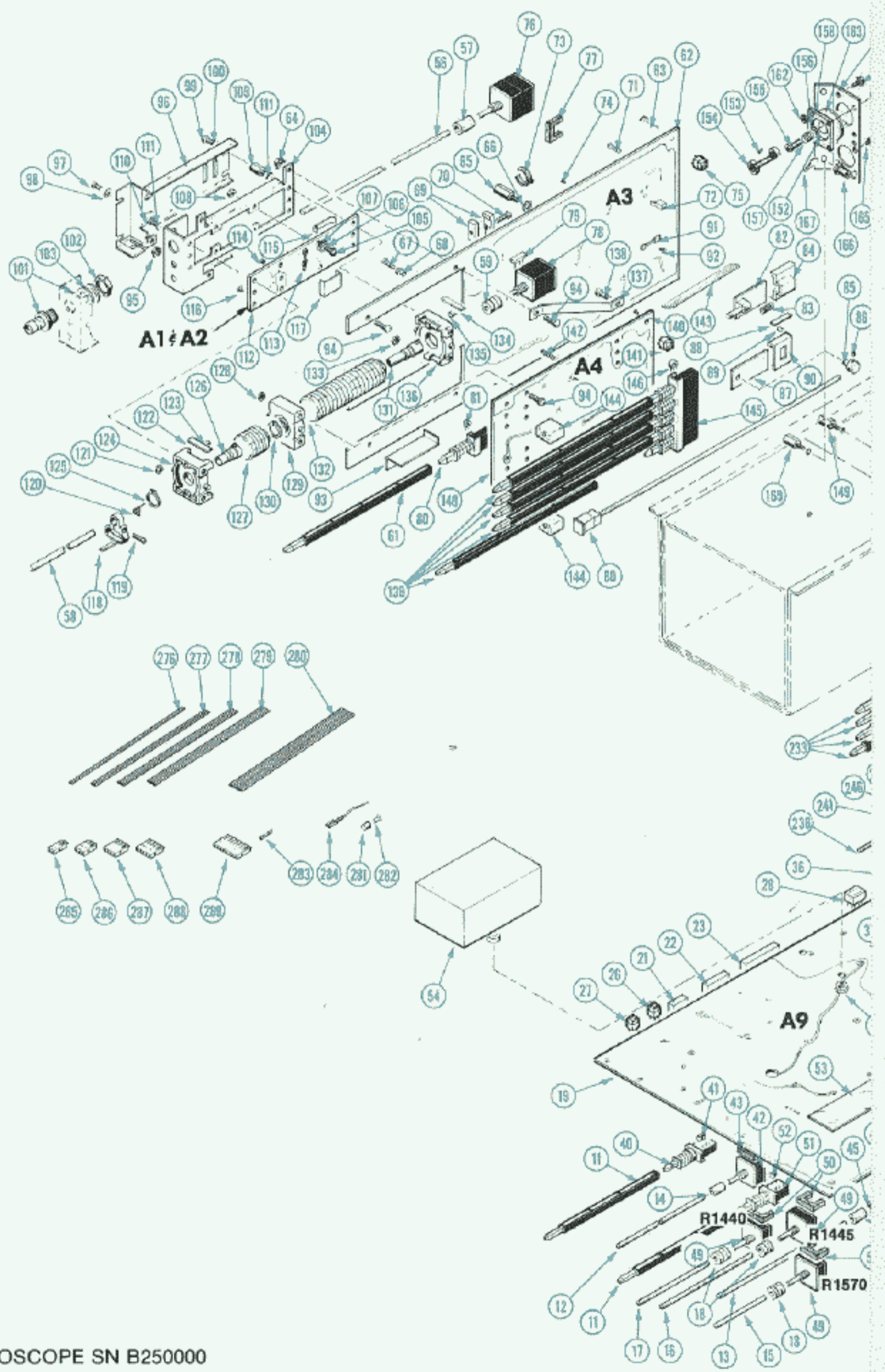

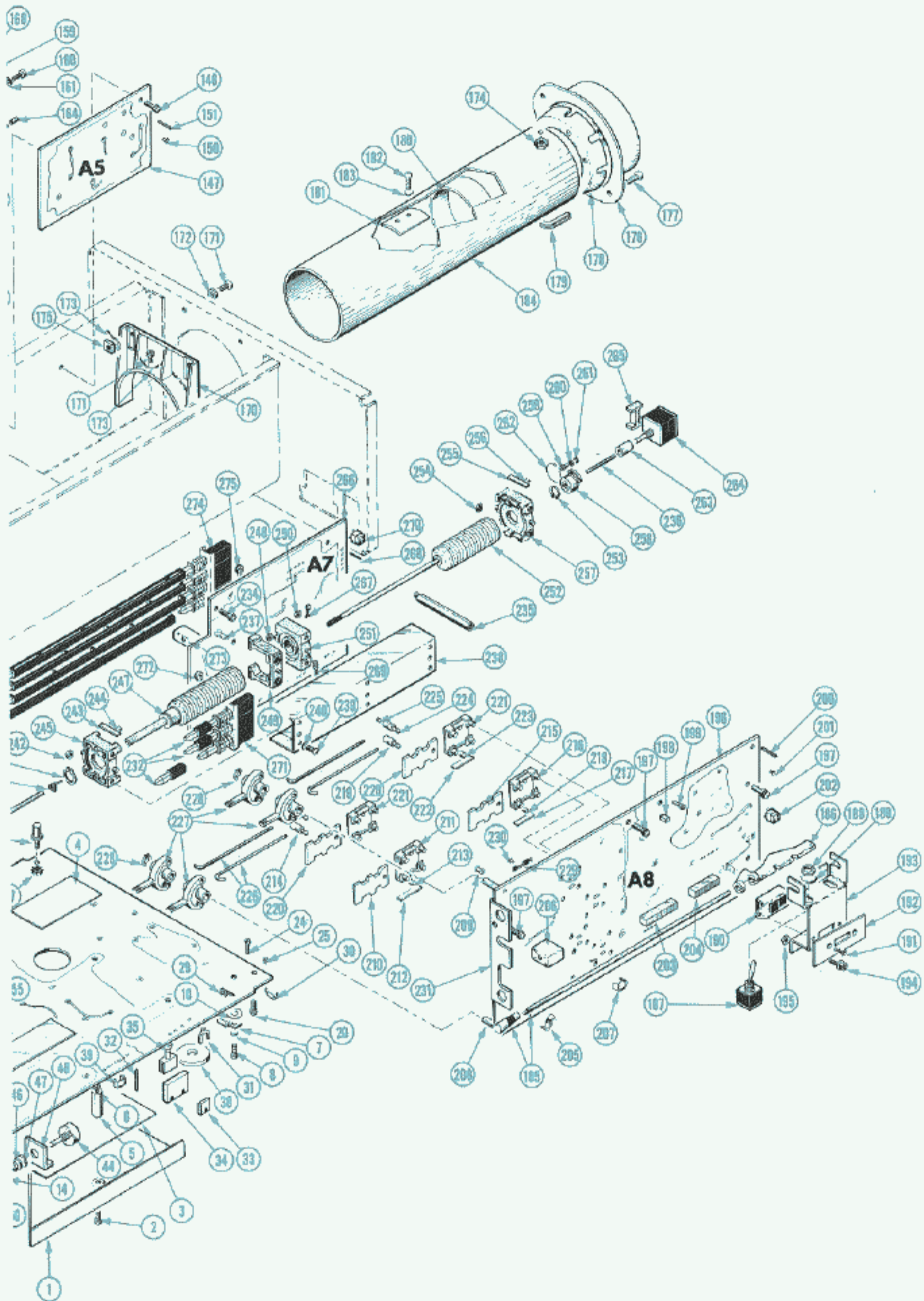

Mechanical Parts List—465 Service (SN B250000-up)

FIGURE 2 CIRCUIT BOARDS

Fig. & Index No.	Tektronix Part No.	Serial/Model No. Eff	No. Dscont	Qty	1 2 3 4 5	Name & Description	Mfr Code	Mfr Part Number
2-1	337-1711-01			1		SHLD,ELECTRICAL:HIGH VOLTAGE (ATTACHING PARTS)	80009	337-1711-01
-2	211-0008-00			4		SCREW,MACHINE:4-40 X 0.25 INCH,PNH STL - - - * - - -	83385	OBD
	131-1428-00			1		CONTACT,ELEC:GROUNDING CLIP	80009	131-1428-00
-3	342-0175-00			1		INSULATOR,FILM:3.65 X 4.70 INCH	80009	342-0175-00
-4	342-0159-00			1		INSULATOR,FILM:5.10 X 12.4 INCHES	80009	342-0159-00
-5	129-0413-00			4		POST,ELEC-MECH:0.538 INCH L	80009	129-0413-00
-6	210-0994-00			4		WASHER,FLAT:0.125 ID X 0.25" OD,STL	83385	OBD
-7	-----			2		TRANSISTOR:(SEE Q1556,1570 EPL) (ATTACHING PARTS FOR EACH)		
-8	211-0182-00			1		SCR,ASSEM,WSHR:2-56 X 0.312 INCH,PNH STL	12360	OBD
-9	210-1156-00			1		WASHER,NONMETAL:0.09 ID X 0.121" OD,NYLON - - - * - - -	80009	210-1156-00
-10	342-0166-00			1		INSULATOR,PLATE:TRANSISTOR	80009	342-0166-00
-11	384-1101-00			2		EXTENSION SHAFT:4.14 INCH LONG	80009	384-1101-00
-12	384-0457-00			1		EXTENSION SHAFT:6.7 INCH LONG	80009	384-0457-00
-13	384-1179-00			1		EXTENSION SHAFT:9.312 INCH LONG	80009	384-1179-00
-14	376-0029-00			2		CPLG,SHAFT,RGD:0.128 ID X 0.312 OD X 0.5"L	80009	376-0029-00
	213-0075-00			2		. SETSCREW:4-40 X 0.094 INCH,HEX SOC STL	70276	OBD
-15	384-1174-00			1		EXTENSION SHAFT:1.80 INCH LONG	80009	384-1174-00
-16	384-1187-00			1		EXTENSION SHAFT:3.40 INCH LONG	80009	384-1187-00
-17	384-1173-00			1		EXTENSION SHAFT:1.90 INCH LONG	80009	384-1173-00
-18	376-0051-00			3		CPLG,SHAFT,FLEX:FOR 0.125 INCH DIA SHAFTS	80009	376-0051-00
	213-0022-00			4		. SETSCREW:4-40 X 0.188 INCH,HEX SOC STL	74445	OBD
-19	-----			1		CKT BOARD ASSY:INTERFACE(SEE A9 EPL) (ATTACHING PARTS)		
-20	211-0207-00			8		SCR,ASSEM WSHR:4-40 X 0.312 INCH,PNH STL - - - * - - -	83385	OBD
	-----			-		. CKT BOARD ASSY INCLUDES:		
-21	136-0499-04			1		. CONNECTOR,RCPT,:4 CONTACT	00779	3-380949-4
-22	136-0499-10			1		. CONNECTOR,RCPT,:10 CONTACT	00779	4-380949-0
-23	136-0499-14			1		. CONNECTOR,RCPT,:14 CONTACT	00779	4-380949-4
-24	214-0579-00			8		. TERM.,TEST PT:0.40 INCH LONG	80009	214-0579-00
-25	136-0252-04			51		. CONTACT,ELEC:0.188 INCH LONG	22526	75060
-26	136-0219-00			2		. SOCKET,PLUG-IN:4 PIN	80009	136-0219-00
-27	136-0220-00			29		. SOCKET,PLUG-IN:3 PIN	71785	133-23-11-034
-28	136-0514-00			2		. SOCKET,PLUG-IN:MICROCIRCUIT,8 CONTACT	82647	C930802
-29	131-1261-00			24		. CONTACT,ELEC:F-SHAPED	00779	1-380953-0
-30	131-0566-00			8		. LINK,TERM.CONNE:0.086 DIA X 2.375 INCH L	0000C	L-2007-1
-31	344-0154-00			2		. CLIP,ELECTRICAL:FOR 0.25 INCH DIA FUSE	80009	344-0154-00
-32	131-0608-00			33		. CONTACT,ELEC:0.365 INCH LONG	22526	47357
-33	124-0118-00			1		. TERMINAL BOARD:1 NOTCH	80009	124-0118-00
-34	124-0092-00			2		. TERMINAL BOARD:3 NOTCH	80009	124-0092-00
-35	358-0214-00			10		. INSULATOR,BSHG:0.25 DIA X 0.188 INCH L	80009	358-0214-00
-36	131-0382-00			1		. TERMINAL STUD:INSULATED (ATTACHING PARTS)	71279	4822-1-0516
-37	210-0586-00			1		. NUT,PLAIN,EXT W:4-40 X 0.25 INCH,STL - - - * - - -	78189	OBD
-38	210-0966-00			1		. WASHER,NONMETAL:0.312 ID X 0.875" OD,RBR	80009	210-0966-00
-39	214-0973-00			1		. HEAT SINK,ELEC:0.28 X 0.18 OVAL X 0.187"H	80009	214-0973-00
-40	-----			1		. SW,PUSH BUTTON:BEAMFINDER(SEE S400 EPL)		
-41	361-0385-00			2		. SPACER,PB SW:0.164 INCH LONG	80009	361-0385-00
-42	-----			1		. RES.,VAR,NONWIR:INTENSITY(SEE R1460 EPL)		
-43	361-0607-00			1		. SPACER,SWITCH:PLASTIC	80009	361-0607-00
-44	-----			1		. RES.,VAR,NONWIR:FOCUS(SEE R1430 EPL) (ATTACHING PARTS)		
-45	210-0583-00			1		. NUT,PLAIN,HEX.:0.25-32 X 0.312 INCH,BRS	73743	2X20319-402
-46	210-0046-00			1		. WASHER,LOCK:INTL,0.26 ID X 0.40" OD,STL	78189	1214-05-00-0541C
-47	210-0940-00			1		. WASHER,FLAT:0.25 ID X 0.375 INCH OD,STL - - - * - - -	79807	OBD

Mechanical Parts List—465 Service (SN B250000-up)

Fig. & Index No.	Tektronix Part No.	Serial/Model No. Eff	No. Dscont	Qty	1 2 3 4 5	Name & Description	Mfr	
							Code	Mfr Part Number
2-48	386-2433-00			1		. SUPPORT,VAR RES:CIRCUIT BOARD MOUNTING	80009	386-2433-00
-49	-----			3		. RES.,VAR, NONWIR:(SEE R1440,1445,1570 EPL)		
-50	361-0607-00			3		. SPACER,SWITCH:PLASTIC	80009	361-0607-00
-51	-----			1		. SW,PUSH BUTTON:X10 MAG(SEE S1239 EPL)		
-52	361-0385-00			2		. SPACER,PB SW:0.164 INCH LONG	80009	361-0385-00
-53	337-1759-00			1		. SHLD,ELECTRICAL:SWEEP	80009	337-1759-00
-54	-----			1		. SEMICOND DEVICE:VOLTAGE MULTR(SEE U1432 EPL) (ATTACHING PARTS)		
-55	220-0661-00	B250000	B252904	2		. NUT,SLFLKG,HEX:8-32 X 0.344 X 0.215",NYLON	23050	OBD
	220-0736-00	B252905		2		. NUT,PL,EXT WSHR:8-32 X 0.343 X 0.437",NYL	23050	OBD
						- - - * - - -		
-56	384-1180-00			2		EXTENSION SHAFT:6.40 INCH LONG	80009	384-1180-00
-57	376-0029-00			2		CPLG,SHAFT,RGD:0.128 ID X 0.312 OD X 0.5"L	80009	376-0029-00
	213-0075-00			2		. SETSCREW:4-40 X 0.094 INCH,HEX SOC STL	70276	OBD
-58	384-1149-00			2		EXTENSION SHAFT:7.0 INCH LONG	80009	384-1149-00
-59	376-0051-00			2		CPLG,SHAFT,FLEX:FOR 0.125 INCH DIA SHAFTS	80009	376-0051-00
	213-0022-00			4		. SETSCREW:4-40 X 0.188 INCH,HEX SOC STL	74445	OBD
-60	384-1162-00			1		EXTENSION SHAFT:11.42 INCH LONG,W/KNOB	80009	384-1162-00
-61	384-1129-00			1		EXTENSION SHAFT:5.607 INCH LONG	80009	384-1129-00
-62	-----			1		CKT BOARD ASSY:VERTICAL PREAMP(SEE A3 EPL) (ATTACHING PARTS)		
-63	211-0207-00			7		SCR,ASSEM WSHR:4-40 X 0.312 INCH,PNH STL	83385	NOTE
-64	210-0586-00			5		NUT,PLAIN,EXT W:4-40 X 0.25 INCH,STL	78189	OBD
-65	129-0413-00			1		POST,ELEC-MECH:0.538 INCH L	80009	129-0413-00
-66	210-0994-00			1		WASHER,FLAT:0.125 ID X 0.25" OD,STL	83385	OBD
						- - - * - - -		
	131-1428-00			1		CONTACT,ELEC:GROUNDING CLIP	80009	131-1428-00
	-----			-		. CKT BOARD ASSY INCLUDES:		
-67	131-0344-00			2		. TERMINAL,STUD:BIFURCATED (ATTACHING PARTS FOR EACH)	88245	421837-9
-68	358-0176-00			1		. INSULATOR,BSHG: - - - * - - -	88245	421472
-69	200-0945-00			6		. COVER,HALF XSTR:FOR DUAL TO-18 CASE	80009	200-0945-00
	200-0945-01			6		. COVER,HALF XSTR:FOR DUAL TO-18 CS,2-56 THD (ATTACHING PARTS FOR EACH)	80009	200-0945-01
-70	211-0062-00			1		. SCREW,MACHINE:2-56 X 0.312 INCH,RDH STL	83385	OBD
						- - - * - - -		
-71	214-0579-00			12		. TERM.,TEST PT:0.40 INCH LONG	80009	214-0579-00
-72	131-1003-00			9		. CONNECTOR BODY,:CKT BD MT,3 PRONG	80009	131-1003-00
-73	352-0086-00			1		. HOLDER,TOROID:	80009	352-0086-00
-74	136-0252-01			2		. CONTACT,ELEC:0.178 INCH LONG	00779	1-332095-2
	136-0252-04			129		. CONTACT,ELEC:0.188 INCH LONG	22526	75060
-75	136-0220-00			8		. SOCKET,PLUG-IN:3 PIN	71785	133-23-11-034
-76	-----			2		. RES.,VAR, NONWIR:(SEE R311,381 EPL)		
-77	361-0607-00			2		. SPACER,SWITCH:PLASTIC	80009	361-0607-00
-78	-----			2		. RES.,VAR, NONWIR:(SEE R112,212 EPL)		
-79	361-0515-00			2		. SPACER,SWITCH:PLASTIC	80009	361-0515-00
-80	-----			1		. SW,PUSH BUTTON:INVERT(SEE S225 EPL)		
-81	361-0411-00			2		. SPACER,PUSH SW:0.13 W X 0.375 INCH L,PLSTC	71590	J64285-00
	105-0421-00			1		. ACTUATOR,SWITCH:	80009	105-0421-00
-82	105-0420-00			1		. . ACTUATOR,SWITCH:	80009	105-0420-00
-83	214-1779-00			1		. . SPRING,HLCPS:0.156 OD X 0.844 INCH LONG	80009	214-1779-00
-84	351-0359-00			1		. . GUIDE,SW SLIDE:	80009	351-0359-00
	105-0423-00			1		. ACTUATOR,SWITCH:	80009	105-0423-00
-85	376-0146-00			1		. . CPLG,SHAFT,RGD:FOR 0.125 INCH DIA SHAFT	80009	376-0146-00
-86	213-0048-00			1		. . SETSCREW:4-40 X 0.125 INCH,HEX SOC STL	74445	OBD
-87	105-0422-00			1		. . ACTUATOR,SWITCH:	80009	105-0422-00
-88	214-1126-01			2		. . SPRING,FLAT:GREEN COLORED	80009	214-1126-01
-89	214-1127-00			2		. . ROLLER,DETENT:0.125 DIA X 0.125 INCH L	80009	214-1127-00
-90	351-0355-00			1		. . GUIDE,SW SLIDE:	80009	351-0355-00
-91	131-1030-00			4		. CONTACT ASSY,EL:CAM SWITCH,BOTTOM	80009	131-1030-00
	131-1031-00			5		. CONTACT ASSY,EL:CAM SWITCH,TOP (ATTACHING PARTS)	80009	131-1031-00
-92	210-0779-00			6		. RIVET,TUBULAR:0.051 OD X 0.115 INCH LONG - - - * - - -	42838	RA-29952715

Mechanical Parts List—465 Service (SN B250000-up)

FIGURE 2 CIRCUIT BOARDS (CONT)

Fig. & Index No.	Tektronix Part No.	Serial/Model No. Eff	No. Dscont	Qty	1	2	3	4	5	Name & Description	Mfr Code	Mfr Part Number
2-93	337-1804-00			2						SHLD,ELECTRICAL:ATTENUATOR	80009	337-1804-00
	672-0416-00			2						CKT BOARD ASSY:CH1 & CH2 ATTENUATORS (ATTACHING PARTS FOR EACH)	80009	672-0416-00
-94	211-0207-00			6						SCR,ASSEM WSHR:4-40 X 0.312 INCH,PNH STL	83385	OBD
-95	210-0586-00			2						NUT,PLAIN,EXT W:4-40 X 0.25 INCH,STL	78189	OBD
										- - - * - - -		
										. EACH ASSY INCLUDES:		
-96	200-1438-00			1						. COVER,CHASSIS:ATTENUATOR (ATTACHING PARTS)	80009	200-1438-00
-97	213-0176-00			3						. SCR,TPG,THD FOR:2-32 X 0.156 INCH,PNH STL	83385	OBD
-98	210-0938-00			3						. WASHER,FLAT:0.109 ID X 0.25 INCH OD,STL	75497	AN960-3
-99	211-0008-00			4						. SCREW,MACHINE:4-40 X 0.25 INCH,PNH STL	83385	OBD
-100	210-0851-00			4						. WASHER,FLAT:0.119 ID X 0.375 INCH OD,STL	12327	OBD
										- - - * - - -		
-101	131-0679-02			1						. CONNECTOR,RCPT,:3 CONTACT BNC,W/HDWR (ATTACHING PARTS)	24931	28JRL68-1
-102	220-0695-00			1						. NUT,PLAIN,DODEC:0.500-28 X 0.90 INCH,BRS	73743	OBD
-103	210-1039-00			1						. WASHER,LOCK:INT,0.521 ID X 0.625 INCH OD	24931	OBD
										- - - * - - -		
-104	441-1095-00			1						. CHAS,ELEC EQUIP:ATTENUATOR (ATTACHING PARTS)	80009	441-1095-00
-105	211-0001-00			2						. SCREW,MACHINE:2-56 X 0.25 INCH,PNH STL	83385	OBD
-106	210-1008-00			2						. WASHER,FLAT:0.09 ID X 0.188" OD,BRS	12360	OBD
-107	210-0053-00			2						. WASHER,LOCK:INTL,0.092 ID X 0.175"OD,STL	83385	OBD
-108	210-0405-00			2						. NUT,PLAIN,HEX.:2-56 X 0.188 INCH,BRS	73743	2X12157-402
-109	129-0299-00			4						. POST,ELEC-MECH:HEX,0.333 INCH LONG	80009	129-0299-00
-110	211-0097-00			2						. SCREW,MACHINE:4-40 X 0.312 INCH,PNH STL	83385	OBD
-111	210-0004-00			6						. WASHER,LOCK:INTL,0.12 ID X 0.26"OD,STL	78189	1204-00-00-0541C
										- - - * - - -		
-112				1						. CKT BOARD ASSY:ATTENUATOR(SEE A1 OR A2 EPL)		
-113	131-1030-00			6						. . CONTACT ASSY,EL:CAM SWITCH,BOTTOM	80009	131-1030-00
	131-1031-00			8						. . CONTACT ASSY,EL:CAM SWITCH,TOP (ATTACHING PARTS)	80009	131-1031-00
-114	210-0779-00			8						. . RIVET,TUBULAR:0.051 OD X 0.115 INCH LONG	42838	RA-29952715
										- - - * - - -		
-115	131-1354-00			2						. . LINK,TERM.CONN:	80009	131-1354-00
-116	136-0252-01			4						. . CONTACT,ELEC:0.178 INCH LONG	00779	1-332095-2
	136-0333-00			1						. . CONTACT,ELEC:0.138 INCH LONG	00779	1-331677-4
-117	337-1406-00			1						. . SHLD,ELECTRICAL:CAM CONTACTS	80009	337-1406-00
	263-1012-00			1						. ACTUATOR ASSY:ATTENUATOR	80009	263-1012-00
-118	105-0243-00			1						. . ACTUATOR,SWITCH: (ATTACHING PARTS)	80009	105-0243-00
-119	213-0214-00			1						. . SCREW,CAP SCH:2-56 X 0.375"HEX HD STL	70278	OBD
										- - - * - - -		
-120	131-0963-00			2						. . CONTACT,ELEC:GROUNDING	80009	131-0963-00
-121	210-0406-00			2						. . NUT,PLAIN,HEX.:4-40 X 0.188 INCH,BRS	73743	2X12161-402
-122	214-1139-03			2						. . SPRING,FLAT:RED COLORED	80009	214-1139-03
-123	214-1752-00			2						. . ROLLER,DETENT:0.125 OD X 0.16 INCH L	80009	214-1752-00
-124	401-0180-00			1						. . BEARING,CAM SW:FRONT (ATTACHING PARTS)	80009	401-0180-00
-125	354-0390-00			1						. . RING,RETAINING:0.385 FREE ID X 0.025",STL	79136	#5100-37MD
										- - - * - - -		
-126	384-0880-00			1						. . SHAFT,CAM SW:VOLTS/DIV REAR,W/DETENT	80009	384-0880-00
-127	105-0282-01			1						. . ACTUATOR,CAM SW:AC/DC GROUND	80009	105-0282-01
	210-1189-00			1						. . WASHER,FLAT:0.195 ID X 0.367" OD,BRS	51316	OBD
	214-2043-00			1						. . SPRING,HLCPS:CONICAL, 0.20 INCH LONG	80009	214-2043-00
-128	210-0406-00			4						. . NUT,PLAIN,HEX.:4-40 X 0.188 INCH,BRS	73743	2X12161-402
-129	401-0178-00			1						. . BEARING,CAM SW:CENTER (ATTACHING PARTS)	80009	401-0178-00
-130	354-0443-00			1						. . RING,RETAINING:0.328 FREE ID X 0.448" OD	97464	200-37
										- - - * - - -		

Mechanical Parts List—465 Service (SN B250000-up)

FIGURE 2 CIRCUIT BOARDS (CONT)

Fig. & Index No.	Tektronix Part No.	Serial/Model No. Eff	Dscont	Qty	1	2	3	4	5	Name & Description	Mfr Code	Mfr Part Number
2-131	384-0878-02			1	SHAFT,CAM SW:W/DRIVER	80009	384-0878-02
-132	105-0342-01			1	ACTUATOR CAM:VOLTS/DIV	80009	105-0342-01
-133	210-0406-00			4	NUT,PLAIN,HEX.:4-40 X 0.188 INCH,BRS	73743	2X12161-402
-134	214-1139-02			1	SPRING,FLAT:GREEN COLORED	80009	214-1139-02
	214-1139-03			1	SPRING,FLAT:RED COLORED	80009	214-1139-03
-135	214-1752-00			2	ROLLER,DETENT:0.125 OD X 0.16 INCH L	80009	214-1752-00
-136	401-0180-00			1	BEARING,CAM SW:REAR	80009	401-0180-00
-137	346-0102-00			1	STRAP,GROUNDING:					80009	346-0102-00	
					(ATTACHING PARTS)							
-138	211-0207-00			1	SCR,ASSEM WSHR:4-40 X 0.312 INCH,PNH STL					83385	OBD	
					- - - * - - -							
-139	384-1129-00			5	EXTENSION SHAFT:5.607 INCH LONG					80009	384-1129-00	
-140	-----			1	CKT BOARD ASSY:VERTICAL MODE(SEE A4 EPL)							
-141	136-0220-00			4	. SOCKET,PLUG-IN:3 PIN					71785	133-23-11-034	
-142	131-0608-00			8	. CONTACT,ELEC:0.365 INCH LONG					22526	47357	
-143	175-0828-00			FT	. WIRE,ELECTRICAL:5 WIRE RIBBON					23499	TEK-175-0828-00	
-144	352-0331-00			2	. LAMPHOLDER:					80009	352-0331-00	
-145	-----			1	. SW,PUSH BUTTON:VERT MODE(SEE S350 EPL)							
-146	361-0411-00			4	. SPACER,PUSH SW:0.375 X 0.13 X 0.199					71590	J-65285-00	
-147	-----			1	CKT BOARD ASSY:VERT OUTPUT(SEE A5 EPL)							
					(ATTACHING PARTS)							
-148	211-0207-00			2	SCR,ASSEM WSHR:4-40 X 0.312 INCH,PNH STL					83385	OBD	
-149	129-0450-00			1	POST,ELEC-MECH:0.656 LG X 0.250"HEX,STUDED					80009	129-0450-00	
					- - - * - - -							
				-	. CKT BOARD ASSY INCLUDES:							
-150	136-0252-04			32	. CONTACT,ELEC:0.188 INCH LONG					22526	75060	
	136-0252-01			2	. CONTACT,ELEC:0.178 INCH LONG					00779	1-332095-2	
-151	131-0608-00			5	. CONTACT,ELEC:0.365 INCH LONG					22526	47357	
-152	-----			2	TRANSISTOR:(SEE Q482,492 EPL)							
-153	210-0627-00			2	RIVET,SOLID:0.042 DIA X 0.25 INCH,RDH					80009	210-0627-00	
-154	343-0097-00			2	RTNR,TRANSISTOR:HEAT SINK					80009	343-0097-00	
					(ATTACHING PARTS FOR EACH)							
-155	210-0599-00			2	NUT,SLEEVE:4-40 X 0.391 INCH LONG					80009	210-0599-00	
-156	210-0004-00			2	WASHER,LOCK:INTL,0.12 ID X 0.26"OD,STL					78189	1204-00-00-0541C	
-157	214-0368-00			1	SPRING,HLCPS:0.24 DIA X 0.438 INCH LONG					80009	214-0368-00	
					- - - * - - -							
-158	352-0062-00			2	HOLDER,SEMICOND:1.187 X 1.187 INCHES,PLSTC					80009	352-0062-00	
					(ATTACHING PARTS FOR EACH)							
-159	211-0033-00			2	SCR,ASSEM WASH.:4-40 X 0.312 INCH,PNH STL					83385	OBD	
-160	211-0012-00			2	SCREW,MACHINE:4-40 X 0.375 INCH,PNH STL					83385	OBD	
-161	210-0004-00			2	WASHER,LOCK:INTL,0.12 ID X 0.26"OD,STL					78189	1204-00-00-0541C	
-162	210-0406-00			4	NUT,PLAIN,HEX.:4-40 X 0.188 INCH,BRS					73743	2X12161-402	
					- - - * - - -							
-163	214-1138-00			2	HEAT SINK,ELEC:TRANSISTOR,1 INCH OD,AL					80009	214-1138-00	
-164	131-0235-00			2	TERMINAL,STUD:0.213 DIA X 0.455 INCH L					88245	420977-9	
					(ATTACHING PARTS FOR EACH)							
-165	358-0136-00			1	INSULATOR,BSHG:					88245	420971	
					- - - * - - -							
-166	131-0761-00			1	TERMINAL STUD:SCREW MTG,FLAT TAB					71279	4897-1-0516	
					(ATTACHING PARTS)							
-167	210-0202-00			1	TERMINAL,LUG:SE #6					78189	2104-06-00-2520N	
					- - - * - - -							
-168	407-1389-00			1	BRKT,HEAT SINK:					80009	407-1389-00	
					(ATTACHING PARTS)							
-169	129-0450-00			2	POST,ELEC-MECH:0.656 LG X 0.250"HEX,STUDED					80009	129-0450-00	
					- - - * - - -							
-170	407-1128-00			1	BRKT,CRT SHIELD:REAR					80009	407-1128-00	
					(ATTACHING PARTS)							
-171	211-0507-00			3	SCREW,MACHINE:6-32 X 0.312 INCH,PNH STL					83385	OBD	
-172	210-0803-00			2	WASHER,FLAT:0.15 ID X 0.375 INCH OD,STL					12327	OBD	
-173	210-0202-00			2	TERMINAL,LUG:SE #6					78189	2104-06-00-2520N	
-174	210-0457-00			1	NUT,PLAIN,EXT W:6-32 X 0.312 INCH,STL					83385	OBD	
-175	220-0419-00			2	NUT,PLAIN,SQ:6-32 X 0.312 INCH,STL					83385	OBD	
					- - - * - - -							

Mechanical Parts List—465 Service (SN B250000-up)

FIGURE 2 CIRCUIT BOARDS (CONT)

Fig. & Index No.	Tektronix Part No.	Serial/Model No. Eff	No. Dscont	Qty	1 2 3 4 5	Name & Description	Mfr Code	Mfr Part Number
2-176	200-1459-00			1		COVER,CRT:REAR (ATTACHING PARTS)	80009	200-1459-00
-177	211-0008-00			2		SCREW,MACHINE:4-40 X 0.25 INCH,PNH STL - - - * - - -	83385	OBD
-178	386-2246-00			1		SUPPORT,CRT:REAR	80009	386-2246-00
-179	348-0145-00			1		GROMMET,PLASTIC:U-SHP,1.0 X 0.42 INCH	80009	348-0145-00
-180	-----			1		COIL,TUBE DEFLE:Y-AXIS(SEE L1446 EPL) (ATTACHING PARTS)		
-181	343-0217-00			1		CLAMP,COIL:	80009	343-0217-00
-182	211-0147-00			2		SCREW,MACHINE:4-40 X 0.25 INCH,PNH STL	83385	OBD
-183	210-0994-00			2		WASHER,FLAT:0.125 ID X 0.25" OD,STL - - - * - - -	83385	OBD
-184	337-1644-00			1		SHLD,ELECTRICAL:CRT NECK	80009	337-1644-00
-185	384-1159-00			1		EXTENSION SHAFT:10.384 INCH LONG,W/KNOB	80009	384-1159-00
-186	214-1756-00			1		ACTUATOR,SWITCH:POWER	80009	214-1756-00
-187	-----			1		SWITCH,TOGGLE:POWER ON(SEE S1501 EPL) (ATTACHING PARTS)		
-188	210-0562-00			1		NUT,PLAIN,HEX.:0.25-40 X 0.312 INCH,BRS	73743	2X20224-402
-189	210-0046-00			1		WASHER,LOCK:INTL,0.26 ID X 0.40" OD,STL - - - * - - -	78189	1214-05-00-0541C
-190	-----			1		SWITCH,SLIDE:LINE SELECT(SEE S1503 EPL) (ATTACHING PARTS)		
-191	211-0101-00			2		SCREW,MACHINE:4-40 X 0.25" 100 DEG,FLH STL - - - * - - -	83385	OBD
-192	200-1526-00			1		COV,INV SW HOLE:	80009	200-1526-00
-193	407-1133-00			1		BRACKET,SW MTG:POWER SWITCH (ATTACHING PARTS)	80009	407-1133-00
-194	211-0116-00			1		SCR,ASSEM WSHR:4-40 X 0.312 INCH,PNH BRS	83385	OBD
-195	210-0551-00			1		NUT,PLAIN,HEX.:4-40 X 0.25 INCH,STL	83385	OBD
	210-0406-00			1		NUT,PLAIN,HEX.:4-40 X 0.188 INCH,BRS	73743	2X12161-402
	210-0994-00			2		WASHER,FLAT:0.125 ID X 0.25" OD,STL	83385	OBD
	386-2660-00			1		SUPPORT,CKT BD:PLASTIC - - - * - - -	80009	386-2660-00
-196	-----			1		CKT BOARD ASSY:TRIG GEN,SWP LOGIC(SEE A8 EPL) (ATTACHING PARTS)		
-197	211-0207-00			5		SCR,ASSEM WSHR:4-40 X 0.312 INCH,PNH STL - - - * - - -	83385	OBD
-198	131-1003-00			8		. CKT BOARD ASSY INCLUDES: . CONNECTOR BODY,:CKT BD MT,3 PRONG	80009	131-1003-00
-199	214-0579-00			3		. TERM.,TEST PT:0.40 INCH LONG	80009	214-0579-00
-200	131-0608-00			10		. CONTACT,ELEC:0.365 INCH LONG	22526	47357
-201	136-0252-04			55		. CONTACT,ELEC:0.188 INCH LONG	22526	75060
-202	136-0220-00			25		. SOCKET,PLUG-IN:3 PIN	71785	133-23-11-034
	136-0260-02			2		. SOCKET,PLUG-IN:16 CONTACT	01295	C931602
-203	136-0499-14			1		. CONNECTOR,RCPT,:14 CONTACT	00779	4-380949-4
-204	136-0499-10			1		. CONNECTOR,RCPT,:10 CONTACT	00779	4-380949-0
-205	200-1167-00			2		. COVER,XSTR:TEMP STAB FOR 2 TO-18 CS STYLE	05820	259-18-40
-206	352-0331-00			3		. LAMPHOLDER:	80009	352-0331-00
-207	214-0973-00			1		. HEAT SINK,ELEC:0.28 X 0.18 OVAL X 0.187"H	80009	214-0973-00
-208	386-2376-00			1		. PLATE,LEVER MTG:SLIDE SWITCH (ATTACHING PARTS)	80009	386-2376-00
-209	210-0657-01			2		. EYELET,METALLIC:0.089 OD X 0.218 INCH LONG - - - * - - -	80009	210-0657-01
	105-0401-00			1		. ACTUATOR,SWITCH:B (DLY'D) SOURCE	80009	105-0401-00
-210	105-0417-00			1		. . ACTUATOR,SWITCH:	80009	105-0417-00
-211	351-0355-00			1		. . GUIDE,SW SLIDE:	80009	351-0355-00
-212	214-1126-01			2		. . SPRING,FLAT:GREEN COLORED	80009	214-1126-01
-213	214-1127-00			2		. . ROLLER,DETENT:0.125 DIA X 0.125 INCH L	80009	214-1127-00
-214	376-0142-00			1		. . ADPT,SHAFT,CPLG:SLIDE TO SHAFT	80009	376-0142-00
	213-0048-00			1		. . SETSCREW:4-40 X 0.125 INCH,HEX SOC STL	74445	OBD

Mechanical Parts List—465 Service (SN B250000-up)

FIGURE 2 CIRCUIT BOARDS (CONT)

Fig. & Index No.	Tektronix Part No.	Serial/Model No. Eff	No. Dscont	Qty	1 2 3 4 5	Name & Description	Mfr Code	Mfr Part Number
2	105-0400-00			1	.	ACTUATOR, SWITCH: A SOURCE	80009	105-0400-00
-215	105-0418-00			1	.	ACTUATOR, SWITCH:	80009	105-0418-00
-216	351-0355-00			1	.	GUIDE, SW SLIDE:	80009	351-0355-00
-217	214-1126-01			2	.	SPRING, FLAT: GREEN COLORED	80009	214-1126-01
-218	214-1127-00			2	.	ROLLER, DETENT: 0.125 DIA X 0.125 INCH L	80009	214-1127-00
-219	376-0142-00			1	.	ADPT, SHAFT, CPLG: SLIDE TO SHAFT	80009	376-0142-00
	213-0048-00			1	.	SETSCREW: 4-40 X 0.125 INCH, HEX SOC STL	74445	OBD
	105-0399-00			2	.	ACTUATOR, SWITCH: A & B COUPLING	80009	105-0399-00
-220	105-0419-00			1	.	ACTUATOR, SWITCH:	80009	105-0419-00
-221	351-0355-00			1	.	GUIDE, SW SLIDE:	80009	351-0355-00
-222	214-1126-00			2	.	SPRING, FLAT: GOLD COLORED	80009	214-1126-00
-223	214-1127-00			2	.	ROLLER, DETENT: 0.125 DIA X 0.125 INCH L	80009	214-1127-00
-224	376-0142-00			1	.	ADPT, SHAFT, CPLG: SLIDE TO SHAFT	80009	376-0142-00
-225	213-0048-00			1	.	SETSCREW: 4-40 X 0.125 INCH, HEX SOC STL	74445	OBD
-226	384-1160-00			4	.	EXTENSION SHAFT: 3.05 INCH LONG	80009	384-1160-00
-227	214-1770-00			4	.	LEVER, SLIDE SW:	80009	214-1770-00
						(ATTACHING PARTS)		
-228	354-0165-00			2	.	RING, RETAINING:	97464	1000-15
						- - - * - - -		
-229	131-1031-00			23	.	CONTACT ASSY, EL: CAM SWITCH, TOP	80009	131-1031-00
						(ATTACHING PARTS FOR EACH)		
-230	210-0779-00			1	.	RIVET, TUBULAR: 0.051 OD X 0.115 INCH LONG	42838	RA-29952715
						- - - * - - -		
-231	407-1157-00			1	.	BRACKET, SWITCH: TRIGGER BOARD	80009	407-1157-00
-232	384-1136-00			3	.	EXTENSION SHAFT: 0.95 INCH LONG	80009	384-1136-00
-233	384-1059-00			4	.	EXTENSION SHAFT: 6.58 INCH LONG	80009	384-1059-00
	672-0451-00			1	.	CKT BOARD ASSY: TIMING	80009	672-0451-00
						(ATTACHING PARTS)		
-234	211-0207-00			1	.	SCR, ASSEM WSHR: 4-40 X 0.312 INCH, PNH STL	83385	OBD
-235	129-0386-00			1	.	POST, ELEC-MECH: HEX, 1.593 INCH LONG	80009	129-0386-00
						- - - * - - -		
						- . TIMING ASSY INCLUDES:		
-236	384-1277-00			1	.	EXTENSION SHAFT: 8.23 INCH LONG	80009	384-1277-00
	263-1086-00			1	.	ACTUATOR ASSY: CAM SWITCH, TIMING		
						(ATTACHING PARTS)		
-237	211-0207-00			8	.	SCR, ASSEM WSHR: 4-40 X 0.312 INCH, PNH STL	83385	OBD
						- - - * - - -		
						- . . ACTUATOR ASSY INCLUDES:		
-238	200-1707-00			1	.	COVER, CAM SW:	80009	200-1707-00
						(ATTACHING PARTS)		
-239	211-0008-00			8	.	SCREW, MACHINE: 4-40 X 0.25 INCH, PNH STL	83385	OBD
-240	210-0004-00			8	.	WASHER, LOCK: INTL, 0.12 ID X 0.26" OD, STL	78189	1204-00-00-0541C
						- - - * - - -		
-241	131-0963-00			2	.	CONTACT, ELEC: GROUNDING	80009	131-0963-00
-242	210-0406-00			2	.	NUT, PLAIN, HEX.: 4-40 X 0.188 INCH, BRS	73743	2X12161-402
-243	214-1139-02			1	.	SPRING, FLAT: GREEN COLORED	80009	214-1139-02
	214-1139-03			1	.	SPRING, FLAT: RED COLORED	80009	214-1139-03
-244	214-1127-00			2	.	ROLLER, DETENT: 0.125 DIA X 0.125 INCH L	80009	214-1127-00
-245	401-0081-02			1	.	BEARING, CAM SW: FRONT	80009	401-0081-02
						(ATTACHING PARTS)		
-246	354-0391-00			1	.	RING, RETAINING: 0.395" FREE ID X 0.025" STL	97464	3100-43-CD
						- - - * - - -		
-247	105-0615-00			1	.	ACTUATOR, CAM SW: TIME/CM, FRONT, W/SHAFT	80009	105-0615-00
-248	210-0406-00			4	.	NUT, PLAIN, HEX.: 4-40 X 0.188 INCH, BRS	73743	2X12161-402
-249	407-1199-00			1	.	BRACKET, COVER: CAM SWITCH	80009	407-1199-00
-250	210-0406-00			4	.	NUT, PLAIN, HEX.: 4-40 X 0.188 INCH, BRS	73743	2X12161-402
-251	401-0115-00			1	.	BEARING, CAM SW: CENTER	80009	401-0115-00
-252	105-0614-00			1	.	ACTUATOR, CAM SW: TIME/CM, REAR, W/SHAFT	80009	105-0614-00
						(ATTACHING PARTS)		
-253	354-0391-00			1	.	RING, RETAINING: 0.395" FREE ID X 0.025" STL	97464	3100-43-CD
						- - - * - - -		

Mechanical Parts List—465 Service (SN B250000-up)

FIGURE 2 CIRCUIT BOARDS (CONT)

Fig. & Index No.	Tektronix Part No.	Serial/Model No. Eff	No. Dscont	Qty	1	2	3	4	5	Name & Description	Mfr Code	Mfr Part Number
2-254	210-0406-00			4	NUT,PLAIN,HEX.:4-40 X 0.188 INCH,BRS	73743	2X12161-402
-255	214-1139-02			1	SPRING,FLAT:GREEN COLORED	80009	214-1139-02
	214-1139-03			1	SPRING,FLAT:RED COLORED	80009	214-1139-03
-256	214-1127-00			2	ROLLER,DETENT:0.125 DIA X 0.125 INCH L	80009	214-1127-00
-257	401-0081-04			1	BEARING,CAM SW:REAR,W/INSERT	80009	401-0081-04
	351-0366-00			1	SLIDE,STOP:ACTUATOR	80009	351-0366-00
	105-0410-00			1	STOP,ROT.SHAFT:CAM SWITCH	80009	105-0410-00
-258	352-0350-00			1	HOLDER,STOP PIN:	80009	352-0350-00
	213-0048-00			1	SETSCREW:4-40 X 0.125 INCH,HEX SOC STL	74445	OBD
-259	105-0409-00			1	STOP,SHAFT:ACTUATOR	80009	105-0409-00
-260	361-0535-00			1	SPACER,RING:0.130 ID X 0.18 INCH OD	80009	361-0535-00
-261	354-0291-00			1	RING,RETAINING:TRUARC	97464	2000-12-CD
-262	214-1812-00			1	SPG,HLCL,TRSN:CAM SWITCH	80009	214-1812-00
-263	376-0039-00			1	ADPT,SHAFT,CPLG:0.128 AND 0.082"DIA SHAFT	80009	376-0039-00
	213-0022-00			2	SETSCREW:4-40 X 0.188 INCH,HEX SOC STL	74445	OBD
-264	-----			1	RES.,VAR,NONWIR:(SEE R1140/S1140 EPL)		
-265	361-0515-00			1	SPACER,SWITCH:PLASTIC	80009	361-0515-00
-266	-----			1	CKT BOARD ASSY:TIMING(SEE A7 EPL)		
-267	131-0604-00			37	CONTACT,ELEC:0.025 SQ X 0.365 INCH LONG	80009	131-0604-00
-268	131-0608-00			19	CONTACT,ELEC:0.365 INCH LONG	22526	47357
-269	131-1261-00			28	CONTACT,ELEC:F-SHAPED	00779	1-380953-0
-270	136-0220-00			2	SOCKET,PLUG-IN:3 PIN	71785	133-23-11-034
-271	-----			1	SW,PUSH BUTTON:TRIG MODE(SEE S1100 EPL)		
-272	361-0542-00			4	SPACER,SWITCH:PLASTIC	71590	J-64281
-273	352-0331-00			2	LAMPHOLDER:	80009	352-0331-00
-274	-----			1	SW,PUSH BUTTON:HORIZ DISPLAY(SEE S1120 EPL)		
-275	361-0385-00			4	SPACER,PB SW:0.164 INCH LONG	80009	361-0385-00
-276	175-0825-00			FT	WIRE,ELECTRICAL:2 WIRE RIBBON,29.5 INCHES						23499	TEK-175-0825-00
-277	175-0826-00			FT	WIRE,ELECTRICAL:3 WIRE RIBBON,3.5 INCHES						08261	TEK-175-0826-00
-278	175-0827-00			FT	WIRE,ELECTRICAL:4 WIRE RIBBON,4 INCHES						08261	TEK-175-0827-00
-279	175-0828-00			FT	WIRE,ELECTRICAL:5 WIRE RIBBON,13 INCHES						23499	TEK-175-0828-00
-280	175-0831-00			FT	WIRE,ELECTRICAL:8 WIRE RIBBON,10.25 INCHES						08261	TEK-175-0831-00
-281	210-0774-00			3	EYELET,METALLIC:0.152 OD X 0.245 INCH L,BRS	80009	210-0774-00
-282	210-0775-00			3	EYELET,METALLIC:0.126 OD X 0.23 INCH L,BRS	80009	210-0775-00
-283	131-0707-00			46	CONTACT,ELEC:0.48"L,22-26 AWG WIRE	22526	47439
	131-0371-00			2	CONTACT,ELEC:FOR NO.26 AWG WIRE	98278	12093-8
-284	131-0472-01			4	CONTACT,ELEC:FEMALE	80009	131-0472-01
-285	352-0169-00			4	HOLDER,TERM.CON:2 WIRE BLACK	80009	352-0169-00
-286	352-0161-00			1	HOLDER,TERM.CON:3 WIRE BLACK	80009	352-0161-00
-287	352-0162-00			1	HOLDER,TERM.CON:4 WIRE BLACK	80009	352-0162-00
-288	352-0163-00			3	HOLDER,TERM.CON:5 WIRE BLACK	80009	352-0163-00
-289	352-0166-00			2	HOLDER,TERM.CON:8 WIRE BLACK	80009	352-0166-00

CABINET

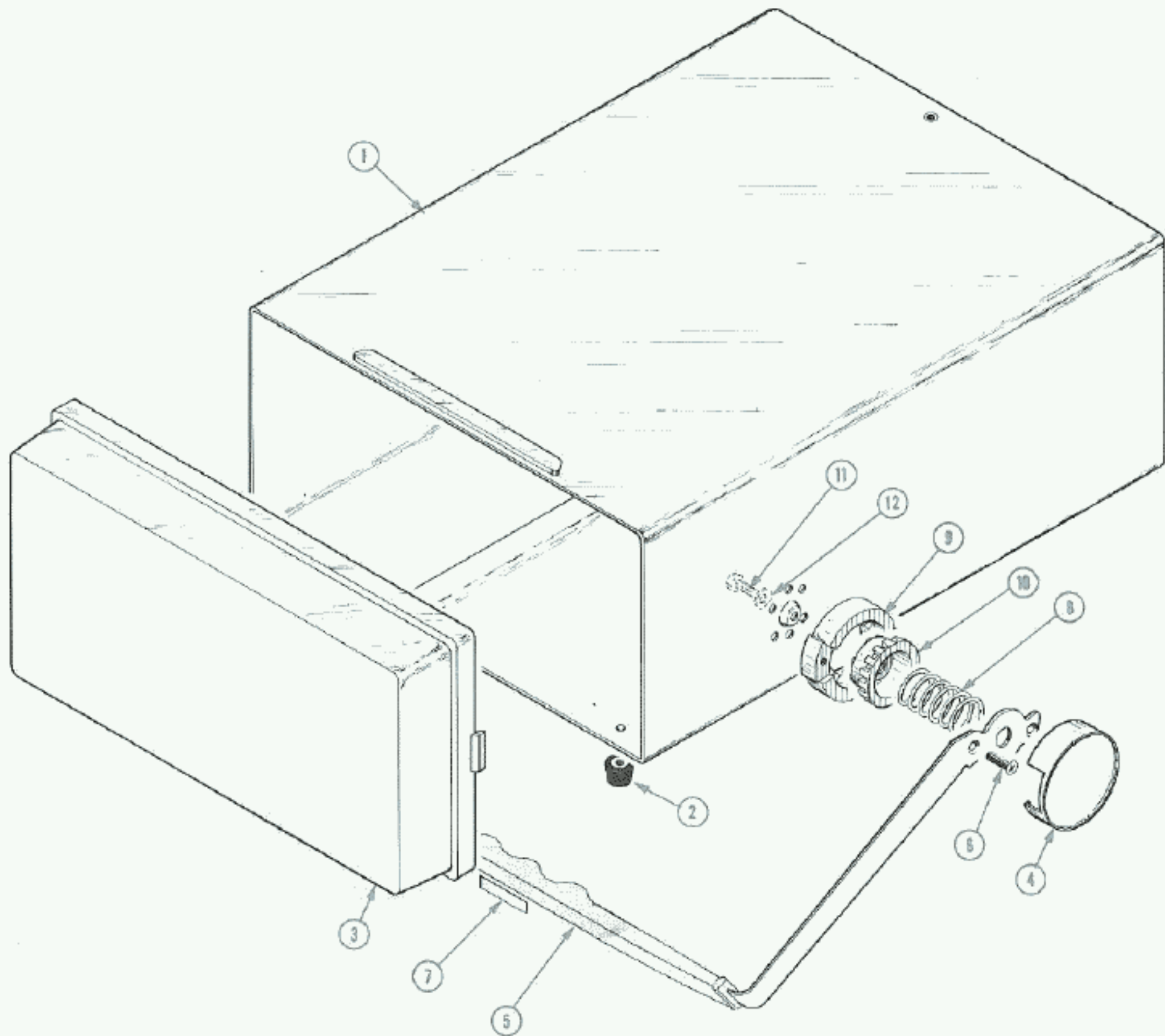

Fig. &
Index
No.

Fig. & Index No.	Tektronix Part No.	Serial/Model No. Eff	No. Dscnt	Qty	1 2 3 4 5	Name & Description	Mfr Code	Mfr Part Number
4-1	437-0141-00			1		CAB,ELEC EQUIP:STANDARD	80009	437-0141-00
	437-0174-00			1		CAB,ELEC EQUIP:WITH DM43/DM40	80009	437-0174-00
-2	348-0080-01			4		. FOOT,CABINET:BOTTOM:	80009	348-0080-01
-3	200-1412-00			1		COVER,SCOPE:FRONT	80009	200-1412-00
	200-1723-00			1		COVER,SCOPE:FRONT,W/DM43/DM40	80009	200-1723-00
-4	200-0602-00			2		COVER,HINGE:	80009	200-0602-00
-5	367-0140-03	B250000	B256499	1		HANDLE,CARRYING:	80009	367-0140-03
	367-0195-00	B256500		1		HANDLE,CARRYING:	80009	367-0195-00
						(ATTACHING PARTS)		
-6	211-0512-00	B250000	B256499	4		SCREW,MACHINE:6-32 X 0.50" 100 DEG,FLH STL	83385	OBD
	213-0227-00	B256500		4		SCR,TPG,THD FOR:6-32 X 0.50 100 DEG,FLH ST	83385	OBD
						-----*		
-7	334-1998-00			1		PL,IDENTIFICATI:	80009	334-1998-00
-8	214-0516-00			2		SPRING,HLCPS:0.959 DIA X 1.250 INCH LONG	80009	214-0516-00
-9	214-0513-04	B250000	B256499	2		HUB,HDL INDEX:	80009	214-0513-04
	214-1987-00	B256500		2		INDEX,HDL RING:	80009	214-1987-00
-10	214-0515-02			2		GEAR,HDL INDEX:	80009	214-0515-02
						(ATTACHING PARTS FOR EACH)		
-11	213-0139-00			1		SCR,CAP,HEX HD:10-24 X 0.375 INCH LONG	14438	OBD
-12	210-1182-00			1		WSHR,SPR TNSN:0.218 ID X 0.69 INCH OD	80009	210-1182-00
						-----*		

Fig. &
Index
No.

Fig. & Index No.	Tektr Part I
4-1	016-053
	016-059
-2	016-053
-3	010-606
	010-643
-4	337-167
-5	134-001
-6	159-001
	159-004
	003-012
	070-186
	070-173
	070-177

ACCESSORIES

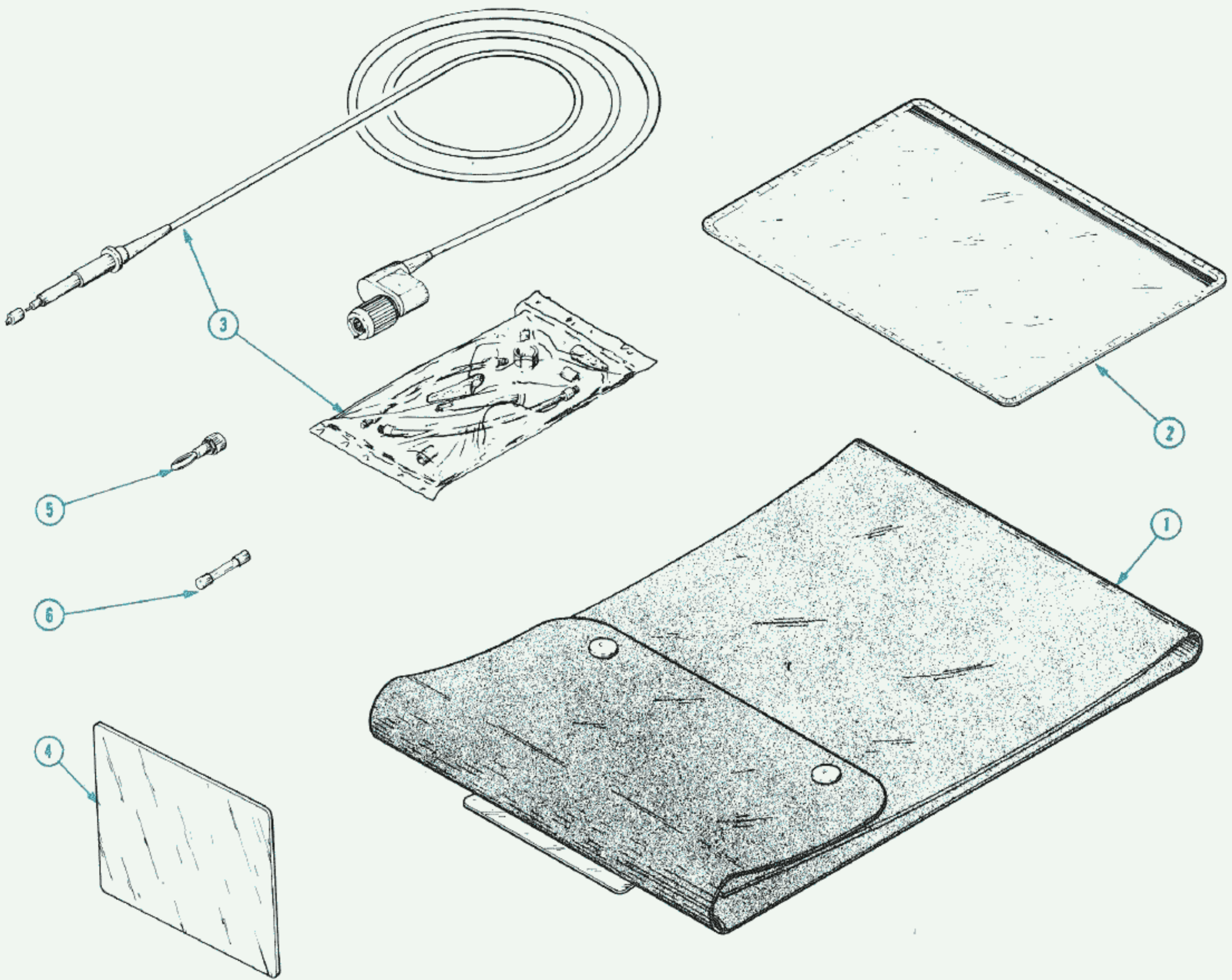

Part Number

41-00
74-00
80-01
12-00
23-00
02-00
40-03
95-00

98-00
16-00
13-04
87-00
15-02

82-00

Fig. & Index No.	Tektronix Part No.	Serial/Model No. Eff	No. Dscont	Qty	1	2	3	4	5	Name & Description	Mfr Code	Mfr Part Number
4-1	016-0535-02			1						POUCH, ACCESSORY: W/HARDWARE, STANDARD	80009	016-0535-02
	016-0594-00			1						POUCH, ACCESSORY: W/HARDWARE, WITH DM43/DM40	80009	016-0594-00
-2	016-0537-00			1						POUCH, ACCESSORY: VINYL, W/ZIPPER	05006	OBD
-3	010-6065-13			2						PROBE, PACKAGE: 6 FOOT	80009	010-6065-13
	010-6430-00			1						PROBE, TEMP: 1.5 METERS LONG, W/DM43	80009	010-6430-00
-4	337-1674-01			1						SHLD, IMPLOSION: CLEAR	80009	337-1674-01
-5	134-0016-01			1						PLUG, TIP: W/BINDING POST	80009	134-0016-01
-6	159-0016-00			2						FUSE, CARTRIDGE: 3AG, 1.5A, 250V, FAST-BLOW	71400	AGC1 1-2
	159-0042-00			2						FUSE, CARTRIDGE: 3AG, 0.75A, 250V, FAST-BLOW	71400	AGC3-4
	003-0120-00			1						TEST LEADS: PAIR, WITH DM43/DM40	80009	003-0120-00
	070-1861-00			1						MANUAL, TECH: INSTRUCTION	80009	070-1861-00
	070-1738-01			1						MANUAL, TECH: OPERATORS	80009	070-1738-01
	070-1779-00			1						MANUAL, TECH: SERVICE, DM43/DM40 (W/DM)	80009	070-1779-00

ACCESSORIES

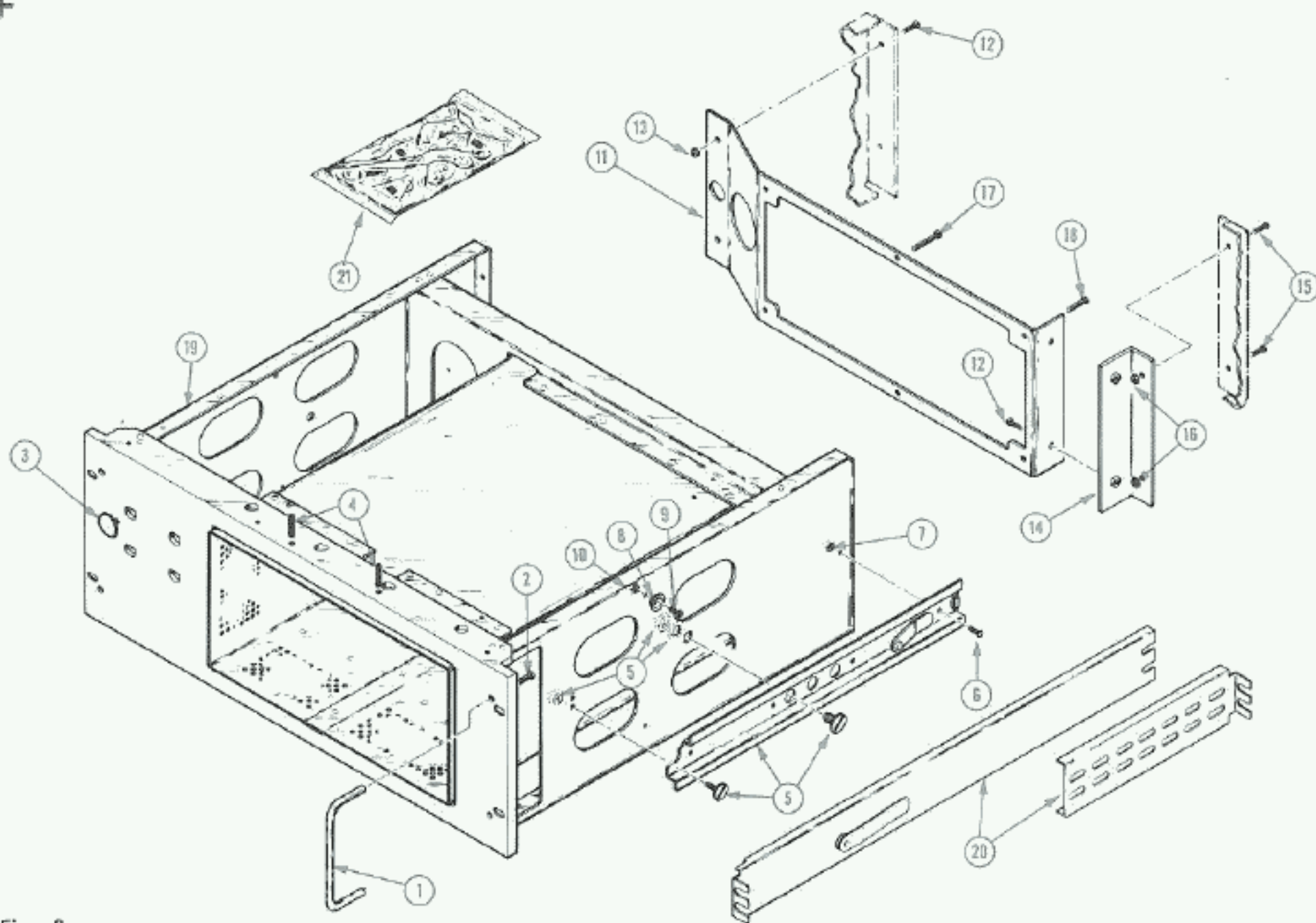
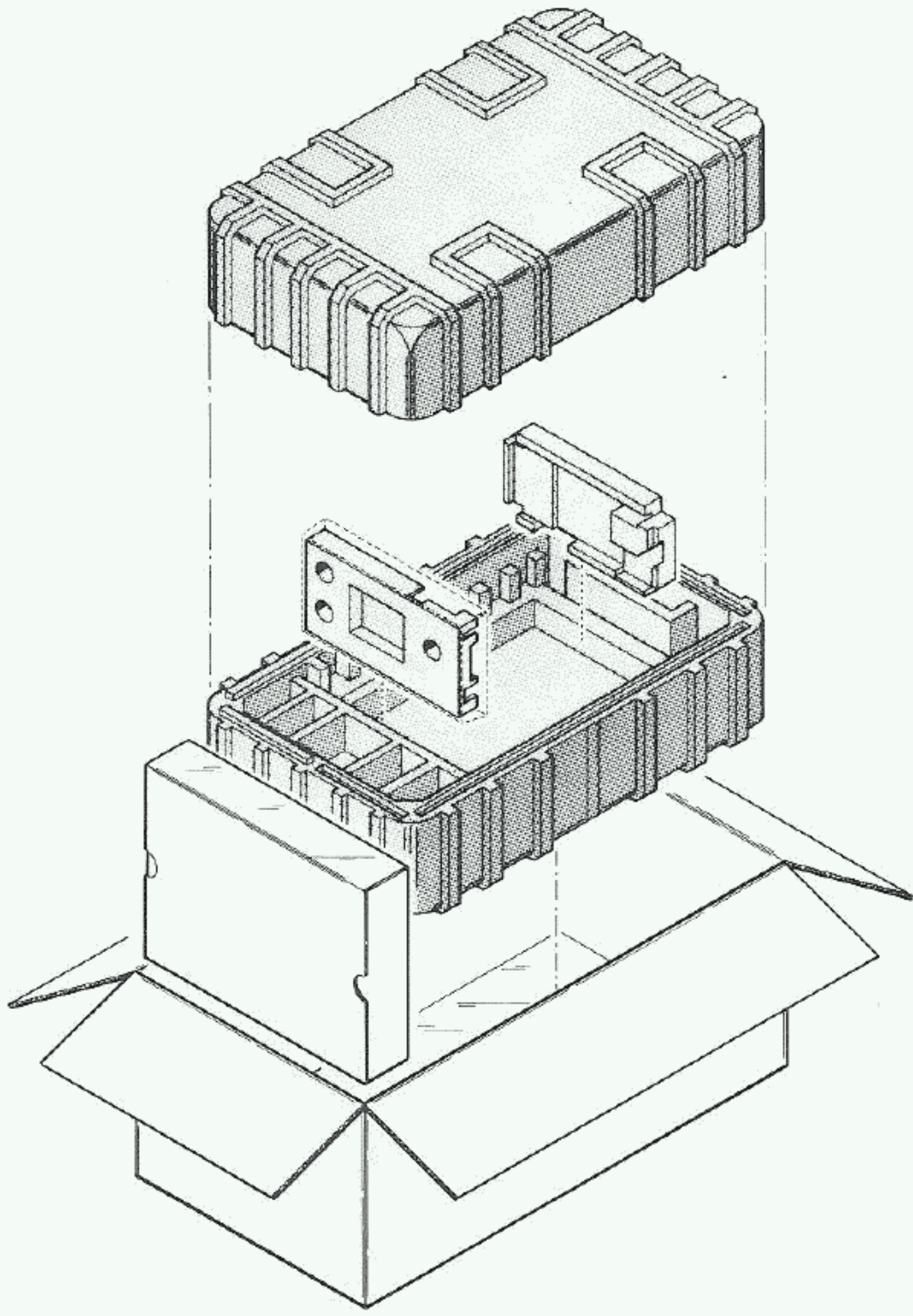

Fig. & Index No.	Tektronix Part No.	Serial, Model No. Eff	Dscont	Qty	1	2	3	4	5	Name & Description	Mfr Code	Mfr Part Number
	016-0556-00			1						ADPTR, RACK MTG:KIT	80009	016-0556-00
-1	367-0022-00			2						HANDLE, BOW:1.5 X 4.5 INCH (ATTACHING PARTS FOR EACH)	06540	10353-B-1032-25A
-2	213-0090-00			2						SCREW, MACHINE:10-32 X 0.50 INCH, HEX	83385	OBD
-3	134-0067-00			4						BUTTON, PLUG:GRAY PLASTIC	80009	134-0067-00
-4	213-0334-00			2						SETSCREW:0.250-28 X 0.750 INCH, SOC STL	56878	OBD
-5	351-0104-00			1						SLIDE SECT., DWR:PAIR (ATTACHING PARTS)	80009	351-0104-00
-6	212-0023-00			2						SCREW, MACHINE:8-32 X 0.375 INCH, PNH STL	83385	OBD
-7	210-0458-00			2						NUT, PLAIN, EXT W:8-32 X 0.344 INCH, STL	83385	OBD
-8	210-0808-00			2						EYELET, METALLIC:CENTERING (ATTACHING PARTS FOR EACH)	63743	2515113-3TP-909
-9	211-0507-00			1						SCREW, MACHINE:6-32 X 0.312 INCH, PNH STL	83385	OBD
-10	210-0457-00			1						NUT, PLAIN, EXT W:6-32 X 0.312 INCH, STL	83385	OBD
-11	386-2669-00			1						SUPPORT, CABINET:REAR (ATTACHING PARTS)	80009	386-2669-00
-12	212-0023-00			4						SCREW, MACHINE:8-32 X 0.375 INCH, PNH STL	83385	OBD
-13	210-0458-00			2						NUT, PLAIN, EXT W:8-32 X 0.344 INCH, STL	83385	OBD
-14	407-1350-00			1						BRACKET, ANGLE:REAR (ATTACHING PARTS)	80009	407-1350-00
-15	212-0023-00			2						SCREW, MACHINE:8-32 X 0.375 INCH, PNH STL	83385	OBD
-16	210-0458-00			2						NUT, PLAIN, EXT W:8-32 X 0.344 INCH, STL	83385	OBD
-17	211-0517-00			2						SCREW, MACHINE:6-32 X 1 INCH, PNH, STL	83385	OBD
-18	212-0033-00			4						SCREW, MACHINE:8-32 X 0.750 INCH, PNH STL	83385	OBD
-19	437-0154-01			1						CABINET, SCOPE:	80009	437-0154-01
-20	351-0101-00			1						SLIDE, DWR, EXT:PAIR	80009	351-0101-00
-21	016-0099-00			1						HDW KIT, ELEK EQ:	80009	016-0099-00



MANUAL CHANGE INFORMATION

At Tektronix, we continually strive to keep up with latest electronic developments by adding circuit and component improvements to our instruments as soon as they are developed and tested.

Sometimes, due to printing and shipping requirements, we can't get these changes immediately into printed manuals. Hence, your manual may contain new change information on following pages.

A single change may affect several sections. Sections of the manual are often printed at different times, so some of the information on the change pages may already be in your manual. Since the change information sheets are carried in the manual until ALL changes are permanently entered, some duplication may occur. If no such change pages appear in this section, your manual is correct as printed.

Repairs

6-17-77 Replaced C-73 - 6.8 MF CAP ON VERTICAL
Preamp Board - 8 VOLT decoupling R.L.